

Current Clamps Catalogue



Measure up



About the CHAUVIN ARNOUX GROUP

Founded in 1893 by Raphaël Chauvin and René Arnoux, **CHAUVIN ARNOUX** is an expert in the measurement of electrical and physical quantities in the industrial and tertiary sectors.

Total control of product design and manufacturing in-house enables the Group to innovate constantly and to propose a very broad product and service offering meeting all its customers' needs.

The Group's quality policy enables it to deliver products which comply with the specifications, as well as the international and national standards, in the metrological, environmental and user-safety sectors.

"CHAUVIN ARNOUX is a major force on the measurement market in France and internationally"

Your partner:

- energy performance
- regulatory testing
- environmental measurements
- installation supervision and sizing.



A few figures

- 100 million euros of sales revenues
- 10 subsidiaries spread across the world
- 900 employees
- 7 production sites
- 6 R&D departments worldwide
- 11 % of revenues invested in R&D



The Current CLamps Catalogue

Table of contents

Clamps and flexible probes "accessories"

■ Theoretical overview	i.1
■ Selection guides	
AC	i.2
AC/DC	i.3
Leakage / Scope / Process / CT output	i.4
■ AC current clamps	
● MINI series	1.0
● MN series	2.0
● Y series	3.0
● C series	4.0
● D series	5.0
● B series	6.0
● MiniFlex® series	7.0
● AmpFlex® series	8.0
■ AC/DC current clamps	
● K series	9.0
● E series	10.0
● MH series	11.0
● PAC series	12.0
■ Accessories	13.0

See last page for details of "made to order" model.

A modern method for measuring electrical currents

INTRODUCTION

Clamp are designed to extend the current measuring capabilities of DMMs, power instruments, oscilloscopes, hand-held scopes, recorders or loggers, and other diverse instruments.

The clamp is placed around the current-carrying conductor to perform non-contact current measurements without interrupting the circuit under test. The clamp outputs current or voltage signals directly proportional to the measured current, thereby providing current measuring and displaying capabilities to instruments with low current or voltage inputs.

When making a measurement, the current-carrying conductor circuit is not broken and remains electrically isolated from the instrument's input terminals. As a result, the instrument's low input terminal may be either floated or earthed. It is not necessary to interrupt the power supply when using a current clamp for taking measurements, so costly downtime can be eliminated.

True RMS measurements within the clamp's frequency response are possible by using most Chauvin Arnoux current clamps with a true RMS multimeter.

In most cases, RMS measurements are not limited by the clamps, but by the instrument to which they are connected. Best results are provided by clamps offering inherent high accuracy, good frequency response, and minimal phase shift.

Several Chauvin Arnoux® clamps are patented for their unique circuitry and design.

AC CURRENT CLAMPS

Theory of Operation:

An AC current clamp may be viewed as a variant of a simple current transformer.

A transformer (figure 1) is essentially two coils wound on a common iron core. A current I_1 is applied through the coil B1, inducing through the common core a current I_2 in the coil B2.

The number of turns of each coil and the current are related by:

$$N_1 \times I_1 = N_2 \times I_2$$

where N_1 and N_2 are the number of turns in each coil.

From this relationship:

$$I_2 = N_1 \times I_1 / N_2 \text{ or } I_1 = N_2 \times I_2 / N_1$$

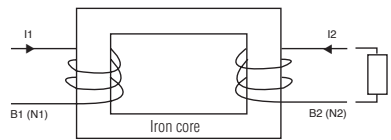

• Figure 1

This same principle is applied to a current clamp (figure 2). The articulated magnetic core holds the coil B2 and clamps onto a conductor where the current I_1 is flowing.

B1 is simply the conductor where the user is measuring the current with the number of turns N_1 equal to one. The current sensor clamped around the conductor provides an output proportional to the number of turns in its coil B2, such that:

$$I_2 \text{ (clamp output)} = N_1 / N_2 \times I_1$$

where $N_1 = 1$ or clamp output = I_1 / N_2 (number of turns in the clamp's coil).

It is often difficult to measure I_1 directly because of currents which are too high to be fed directly into a meter or simply because breaking into the circuit is not possible. To provide a manageable output level, a known number of turns is made on the clamp's coil.

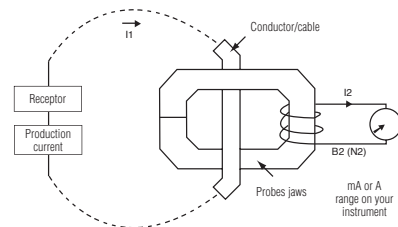

• Figure 2

The number of turns in the winding of the clamp is usually a whole number (e.g. 100, 500 or 1,000). If N_2 equals 1000, then the clamp has a ratio of N_1 / N_2 or $1 / 1000$, which is expressed as 1000:1.

Another way to express this ratio is to say that the clamp output is 1 mA/A - the clamp output is 1 mA (I_2) for 1 A (or 1 A @ 1,000 A) flowing in the jaw window.

There are numerous other ratios possible: 500:5, 2000:2, 3000:1, 3000:5, etc. for different applications.

The most common application is the use of a current clamp with a digital multimeter. Take as an example a current clamp with a ratio of 1000:1 (model C100) with an output of 1 mA/A. This ratio means that any current flowing through the probe jaws will result in a current flowing at the output:

Conductor input	Clamp output
1,000 A	1 A
750 A	750 mA
250 A	250 mA
10 A	10 mA

The clamp output is connected to a DMM set on the AC current range to handle the clamp output. Then, to determine the current in the conductor, multiply the reading of the DMM by the ratio (e.g., 150 mA read on the 200 mA DMM range represents $150 \text{ mA} \times 1000 = 150 \text{ A}$ in the conductor measured).

Current clamps may be used with other instruments with current ranges, provided that these instruments have the required input impedance (see figure 3).

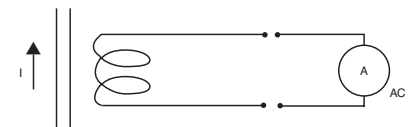

• Figure 3

Current clamps may also have AC or DC voltage outputs to accommodate current measurements with instruments (loggers, scopes, etc.) with voltage ranges only (figures 4 and 5).

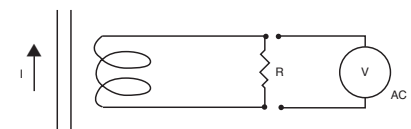

• Figure 4

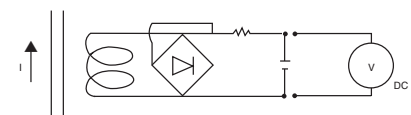

• Figure 5

This is simply done by conditioning the current clamp output inside the clamp to provide voltage (e.g., model Y4N or MINI09). In these cases, the probe mV output is proportional to the measured current.

A modern method for measuring electrical currents

• Operating principle

The AmpFlex® and MiniFlex® sensors are based on the principle of the Rogowski coil. The primary circuit is constituted by the conductor carrying the alternating current to be measured, while the secondary is formed by a special coil wound on a flexible support. At its terminals, this coil develops a voltage proportional to the derivative of the primary current to be measured:

$$u = \frac{\mu_0 \cdot n}{2\pi \cdot r} \times S \cdot \frac{di}{dt}$$

where μ_0 = vacuum permeability
 S = surface area of a turn
 n = number of turns
 r = core radius

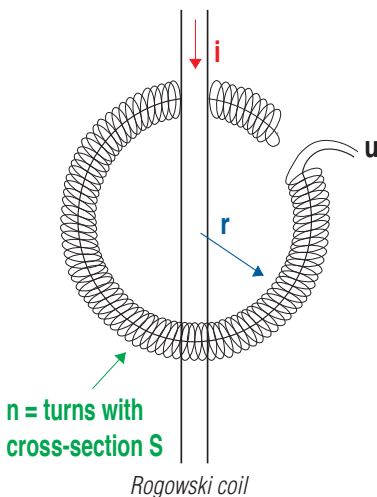

This AC voltage u is then passed via a screened cable to the casing containing all the processing electronics and the battery power supply. Because there are not magnetic circuits on these sensors, they are very lightweight and flexible. Without magnetic circuits, there is no saturation effect or overheating. This feature ensures excellent linearity and low phase shift.

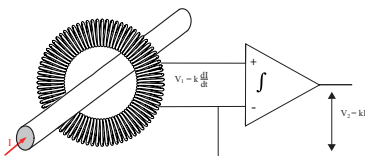

AC/DC CLAMP-ON CURRENT PROBES

• Theory of Operation (Hall effect)

Unlike on traditional AC transformers, AC/DC current measurement is often achieved by measuring the strength of a magnetic field created by a current-carrying conductor in a semiconductor chip using the Hall-effect principle. When a thin semiconductor (figure 6) is placed at right angles to a magnetic field (B), and a current (I_d) is applied to it, a voltage (V_h) is developed across the semiconductor. This voltage is known as the Hall voltage, named after the US scientist Edwin Hall who first reported the phenomenon.

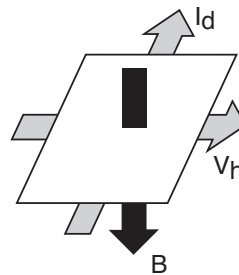

• Figure 6

When the Hall device drive current (I_d) is held constant, the magnetic field (B) is directly proportional to the current in a conductor. Thus, the Hall output voltage (V_h) is representative of that current. Such an arrangement has two important benefits for universal current measurement.

First, since the Hall voltage is not dependent on a reversing magnetic field, but only on its strength, the device can be used for DC measurement. Second, when the magnetic field strength varies due to varying current flow in the conductor, response to change is instantaneous. Thus, complex AC wave forms may be detected and measured with high accuracy and low phase shift.

The basic construction of a clamp jaw assembly is shown in figure 7, (note: one or two Hall generators are used depending on the type of current clamp).

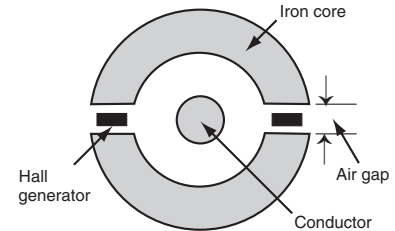

• Figure 7

The Chauvin Arnoux AC/DC current clamps were developed using the above principle, together with patented electronic circuitry incorporating signal conditioning for linear output and a temperature compensation network. These have a wide dynamic range and frequency response with highly accurate linear output, for application in all areas of current measurement up to 1,500 A. Direct currents can be measured without the need of expensive, power-consuming shunts, and alternating currents up to several kHz can be measured accurately to respond to the requirements of complex signals and RMS measurements.

The clamp outputs are in mV (mV DC when measuring DC, and mV AC when measuring AC) and may be connected to most instruments with a voltage input, such as DMMs, loggers, oscilloscopes, handheld scopes, recorders, etc.

Chauvin Arnoux also offers various technologies for DC measurements, as in the K1 and K2, designed to measure very low DC currents and using saturated magnetic circuit technology. The AC/DC clamps also offer the opportunity to display or measure True RMS in AC or AC+DC.

A modern method for measuring electrical currents

AC OR DC CURRENT MEASUREMENT

- Connect the clamp to the instrument
- Select the function and range
- Clamp the clamp around a single conductor
- Read the conductor's current value

Examples (figure 8):

AC: clamp model: Y2N

Ratio: 1000:1
 Output: 1 mA AC/A AC
 DMM: set to 200 mA AC range
 DMM reading: 125 mA AC
 Current in conductor:
 $125 \text{ mA} \times 1000 = 125 \text{ A AC}$

DC: clamp model: PAC 21

1 mV DC/A DC (Hall sensor)
 DMM: set to 200 mV DC range
 DMM reading: 160 mV DC
 Current in conductor: 160 A DC

AC: clamp model: PAC 11

Output: 1 mV AC/A AC
 (Hall sensor)
 DMM: set to 200 mV AC range
 DMM reading: 120 mV AC
 Current in conductor: 120 A AC

DC: micro clamp K1

Output: 1 mV/mA
 DMM: set to 200 mV DC range
 DMM reading: 7.4 mV DC
 Current in conductor: 7.4 mA

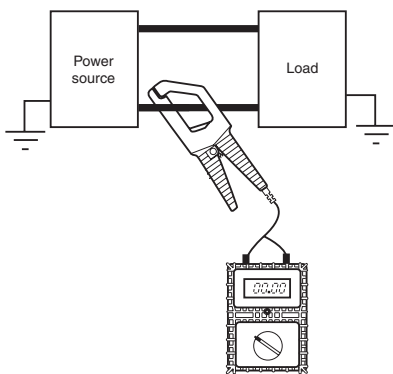

• Figure 8

MEASUREMENTS OF LOW CURRENTS, PROCESS LOOPS AND LEAKAGE CURRENTS

Numerous clamps are offered for low current measurements. For example, models K1 and K2 have a 50 mA DC sensitivity and the model K2 may be used on 4-20 mA process loops.

Example: 4-20 mA loop

Clamp model: K2
 Output: 10 mV/mA
 DMM: set to 200 mV DC range
 DMM reading: 135 mV DC
 Loop current: 13.5 mA DC

When the current to be measured is too low for the clamp or better accuracy is required, it is possible to insert the conductor multiple times through the probe jaws. The value of the current is the ratio of the reading to the number of turns.

Example: figure 9

Clamp model: C100
 Ratio: 1000:1
 DMM: set to 200 mA AC range
 Turns in clamp jaw: 10
 DMM reading: 60 mA AC
 Current in conductor:
 $60 \text{ mA} \times 1,000 / 10 = 6,000 \text{ mA} = 6 \text{ A}$

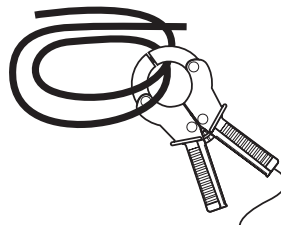

• Figure 9

When the clamp is placed around two conductors with different polarities, the resulting reading will be the difference between the two currents. If the currents are the same, the reading will be zero (figure 10).

When a reading other than zero is obtained, the reading is the amount of leakage current on the load.

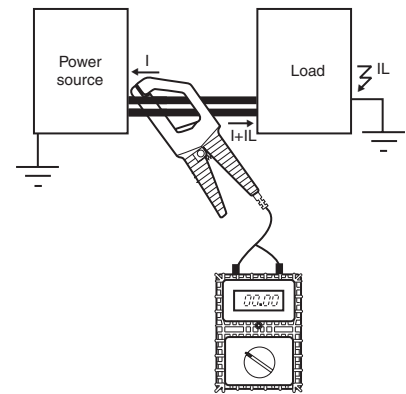

• Figure 10

To measure low currents or leakage, you need a clamp which will measure low values, such as the model B102 or C173. However, earth leakage currents may also be measured directly with the simple model (figure 11).

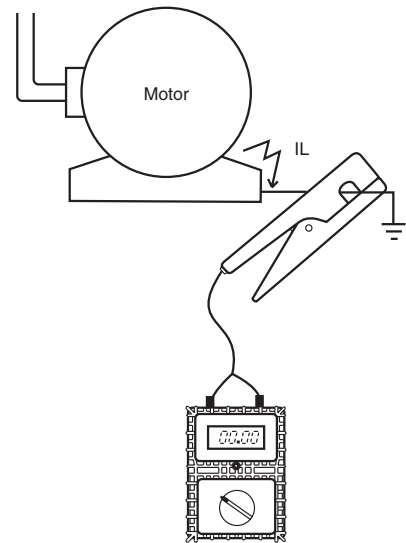

• Figure 11

Example: figure 11

MINI 05

Ratio: 1 mV AC/mA AC
 DMM: set to 200 mA AC range
 DMM reading: 10 mV AC
 Leakage current: 10 mA AC



SELECTING A CURRENT PROBE

Answering the following questions will help you to select the appropriate clamp for your applications:

1. Determine if you are measuring AC or DC (DC current clamps are categorized as AC/DC because they measure both).
2. What is the the maximum current you will measure, and what is the minimum current you will measure? Check that the accuracy at low levels is appropriate, or select a low-current measurement clamp. Most clamps perform with greater accuracy at the upper end of their range. Several clamps are designed to measure very low DC or AC.
3. What size conductor will you clamp onto? This parameter determines the clamp jaw size needed.
4. What type of clamp output do you need or can you work with (mA, mV, AC, DC, etc.)? Check the maximum receiver impedance to ensure that the clamp will perform to specifications.

Other factors you may want to consider:



- What is the working voltage of the conductor to be measured ?
- Chauvin Arnoux clamps must not be used above 600 volts (see specifications).
- What type of termination do you need: sockets, banana leads or BNC leads ?
- Will the probe be used for harmonics or power clamp ?
Look at the frequency specifications and phase shift specifications.

Series	Model	Input						Output - Connections				Specific features					To order		
		Measuring range ⁽¹⁾						Current	Voltage	Lead + Ø 4 mm safety connectors ⁽²⁾	Ø 4 mm female sockets	BNC connector (coaxial)	Transformation ratio (input/output)	Output protected against voltage surges	Automatic DC voltage	Measurement of power (slight phase shift)		Bandwidth (frequency in Hz)	Typical accuracy
		Very weak current	Weak current	Medium current	Strong current	AC	DC												
 Chap. 1	MINI 01	2 A .. 150 A					0.15 A AC		●			1000/1	●			48 Hz .. 500 Hz	≤ 2.5%	P01105101Z	
	MINI 02	50 mA .. 100 A					0.1 A AC		●			1000/1	●	●		48 Hz .. 10 kHz	≤ 1%	P01105102Z	
	MINI 03	1 A .. 100 A						0.1 V AC	●			1 A / 1 mV				48 Hz .. 500 Hz	≤ 2%	P01105103Z	
	MINI 05	5 mA .. 10 A						10 V AC	●			1 mA / 1 mV					≤ 3%	P01105105Z	
	MINI 09	1 A .. 150 A						0.1 V AC	●			1 A / 1 mV				≤ 2%	P01105109Z		
	MINI 102	0.05 A - 200 A					0.2 A AC		●			1000/1	●			48 Hz .. 10 kHz	≤ 1%	P01106102	
	MINI 103	0.1 A - 200 A						0.2 V AC	●			1 A / 1 mV	●			≤ 1.5%	P01106103		
 Chap. 2	MN 08	0.5 A .. 240 A					0.2 A AC		●	●		1000/1			40 Hz .. 10 kHz	≤ 1%	P01120401		
	MN 09	0.5 A .. 240 A					0.2 A AC		●			1000/1				≤ 1%	P01120402		
	MN 10	0.5 A .. 240 A					0.2 A AC		●	●		1000/1	●			≤ 2%	P01120403		
	MN 11	0.5 A .. 240 A					0.2 A AC		●			1000/1	●			≤ 2%	P01120404		
	MN 12	0.5 A .. 240 A						2 V AC	●	●		1 A / 10 mV				≤ 1%	P01120405		
	MN 13	0.5 A .. 240 A						2 V AC	●			1 A / 10 mV				≤ 1%	P01120406		
	MN 14	0.5 A .. 240 A						0.2 V AC	●	●		1 A / 1 mV				≤ 1%	P01120416		
	MN 15	0.5 A .. 240 A						0.2 V AC	●			1 A / 1 mV				≤ 1%	P01120417		
	MN 21	0.1 A .. 240 A					0.2 A AC		●			1000/1	●			≤ 2%	P01120418		
	MN 23	0.1 A .. 240 A						2 V AC	●			1 A / 10 mV				≤ 1.5%	P01120419		
	MN 38	0.1 A .. 24 A						2 V AC		●		1 A / 100 mV				≤ 1%	P01120407		
	MN 39	0.5 A .. 240 A						2 V AC		●		1 A / 10 mV				≤ 1%	P01120408		
	MN 60	0.1 A .. 60 A peak						6 V peak		●	●	1 A / 100 mV				≤ 2%	P01120409		
	MN 71	10 mA .. 12 A						6 V peak		●		1 A / 10 mV				≤ 1.5%	P01120420		
	MN 73	10 mA .. 2.4 A						1 V AC	●			1 A / 100 mV				≤ 1%	P01120421		
MN 88	100 mA .. 240 A						2 V AC	●			1 A / 10 mV			≤ 2%	P01120410				
MN 89	0.5 A .. 240 A						2 V AC	●			1 A / 10 mV			≤ 2%	P01120415				
 Chap. 3	Y1N	4 A .. 500 A					0.5 A AC		●			1000/1	●		48 Hz .. 1 kHz	≤ 3%	P01120001A		
	Y2N	4 A .. 500 A					0.5 A AC		●			1000/1	●			≤ 1%	P01120028A		
	Y3N	4 A .. 500 A					5 A AC		●			100/1				≤ 3%	P01120029A		
	Y4N	4 A .. 500 A						0.5 V DC ⁽²⁾	●			500 A / 0.5 V				≤ 1%	P01120005A		
	Y7N	1 A .. 1,200 A peak						1.2 V peak		●	●	1 A / 1 mV				≤ 2%	P01120075		

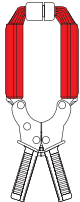

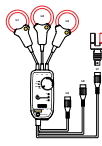
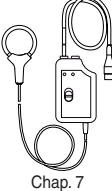
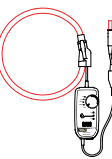
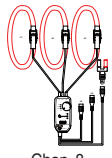

(1) The upper value corresponds to 120 % of the maximum rated value (2) Remise en forme du signal alternatif par diodes
 (3) Lead + electronic unit with Ø 4 mm safety connectors, centre distance 19 mm, for Kand AmpFlex®

Series	Model	Input						Output - Connections				Specific features						To order	
		Measuring range ⁽¹⁾						Current	Voltage	Lead + Ø 4 mm safety connectors ⁽²⁾	Ø 4 mm female sockets	BNC connector (coaxial)	Transformation ratio (input/output)	Output protected against voltage surges	Automatic DC voltage	Measurement of power (slight phase shift)	Bandwidth (frequency in Hz)		Typical accuracy
		Very weak current	Weak current	Medium current	Strong current	AC	DC												
 Chap. 4	C100	0.1 A .. 1,200 A				●	1 A AC		●			1000/1				30 Hz .. 10 kHz	≤ 0.5%	P01120301	
	C102	0.1 A .. 1,200 A				●	1 A AC		●			1000/1	●				≤ 0.5%	P01120302	
	C103	0.1 A .. 1,200 A				●	1 A AC		●			1000/1	●				≤ 0.5%	P01120303	
	C106	0.1 A .. 1,200 A				●		1 V AC	●			1 A / 1 mV					≤ 0.5%	P01120304	
	C107	0.1 A .. 1,200 A				●		1 V AC	●			1 A / 1 mV					≤ 0.5%	P01120305	
	C112	1 mA .. 1,200 A				●	1 A AC		●			1000/1	●	●			≤ 0.3%	P01120314	
	C113	1 mA .. 1,200 A				●	1 A AC		●			1000/1	●	●			≤ 0.3%	P01120315	
	C116	1 mA .. 1,200 A				●		1 V AC	●			1 A / 1 mV		●			≤ 0.3%	P01120316	
	C117	1 mA .. 1,200 A				●		1 V AC	●			1 A / 1 mV		●			≤ 0.3%	P01120317	
	C122	1 A .. 1,200 A				●	5 A AC		●			1000/5	●				≤ 1%	P01120306	
	C148	1 A .. 300 A				●	5 A AC		●			250/5	●				48 Hz .. 1 kHz	≤ 2%	P01120307
		1 A .. 600 A										500/5						≤ 1%	
1 A .. 1,200 A				1000/5	≤ 1%														
C160	0.1 A .. 30 Apeak				●		3 Vpeak		●		10 A / 1 V				10 Hz .. 100 kHz	≤ 3%	P01120308		
	0.1 A .. 300 Apeak										100 A / 1 V					≤ 2%			
	1 A .. 2,000 Apeak										1,000 A / 1 V					≤ 1%			
C173	1 mA .. 12 A				●		1 V AC		●		1 A / 1 V				10 Hz .. 3 kHz	≤ 0.7%	P01120309		
	0.01 A .. 12 A										10 A / 1 V					≤ 0.5%			
	0.1 A .. 120 A										100 A / 1 V					≤ 0.3%			
	1 A .. 1,200 A										1,000 A / 1 V					≤ 0.2%			
 Chap. 5	D30N	1 A .. 3,600 A				●	1 A AC		●		3000/1	●	●	30 Hz .. 5 kHz	≤ 0.5%	P01120049A			
	D30CN	1 A .. 3,600 A				●	1 A AC		●		3000/1	●	●		≤ 0.5%	P01120064			
	D31N	1 A .. 600 A				●	1 A AC			●		500/1	●		30 Hz .. 1.5 kHz	≤ 3%	P01120050A		
		1 A .. 1,200 A										1000/1				≤ 1%			
		1 A .. 1,800 A										1500/1				≤ 0.5%			
	D32N	1 A .. 1,200 A				●	1 A AC			●		1000/1	●	●	30 Hz .. 1 kHz	≤ 1%	P01120051A		
		1 A .. 2,400 A										2000/1				≤ 0.5%			
		1 A .. 3,600 A										3000/1				≤ 0.5%			
	D33N	1 A .. 3,600 A				●	5 A AC		●			3000/5			30 Hz .. 5 kHz	≤ 1%	P01120052A		
	D34N	1 A .. 600 A				●	5 A AC			●		500/5			30 Hz .. 1.5 kHz	≤ 3%	P01120053A		
		1 A .. 1,200 A										1000/5				≤ 1%			
		1 A .. 1,800 A										1500/5				≤ 0.5%			
D35N	1 A .. 1,200 A				●	5 A AC			●		1000/5		●	30 Hz .. 1.5 kHz	≤ 1%	P01120054A			
	1 A .. 2,400 A										2000/5				≤ 0.5%				
	1 A .. 3,600 A										3000/5				≤ 0.5%				
D36N	1 A .. 3,600 A				●	3 A AC		●			3000/3	●	●	30 Hz .. 5 kHz	≤ 0.5%	P01120055A			
D37N	0.1 A .. 36 A				●		3 V AC		●		30 A/3 V			30 Hz .. 5 kHz	≤ 2%	P01120056A			
	1 A .. 360 A										300 A/3 V								
	1 A .. 3,600 A										3,000 A/3 V								
D38N	1 A .. 90 Apeak				●		0.9 Vpeak		●		1 A / 10 mV			30 Hz .. 50 kHz	≤ 2%	P01120057A			
	1 A .. 900 Apeak										1 A / 1 mV								
	1 A .. 9,000 Apeak										1 A / 0.1 mV								

(1) The upper value corresponds to 120 % of the maximum rated value
 (2) Lead + electronic unit with Ø 4 mm safety connectors, centre distance 19 mm, for K and AmpFlex®

Series	Model	Input						Output - Connections				Specific features						To order
		Measuring range ⁽¹⁾						Current	Voltage	Lead + Ø 4 mm safety connectors ⁽³⁾	Ø 4 mm female sockets	BNC connector (coaxial)	Transformation ratio (input/output)	Output protected against voltage surges	Automatic DC voltage	Measurement of power (slight phase shift)	Bandwidth (frequency in Hz)	
Very weak current	Weak current	Medium current	Strong current	AC	DC													
 Chap. 6	B102	500 µA .. 4 A	0.5 A .. 400 A					4 V AC 0.4 V AC	●			1 mA / 1 mV 1 A / 1 mV				10 Hz .. 1 kHz	≤ 0.5 % ≤ 0.35 %	P01120083
 Chap. 7	MA110 3-30-300-3000/3 (17 cm / Ø 4.5 cm)	0.08 A - 3 A 0.5 A .. 30 A 0.5 A .. 300 A 0.5 A .. 3,000 A						3 V AC	●			1 V/A 100 mV/A 10 mV/A 1 mV/A			●	10 Hz .. 10 kHz 10 Hz .. 20 kHz 10 Hz .. 20 kHz 10 Hz .. 20 kHz	≤ 1 %	P01120660
	MA110 3-30-300-3000/3 (25 cm / Ø 7 cm)																	P01120661
	MA110 3-30-300-3000/3 (35 cm / Ø 10 cm)																	P01120662
 Chap. 7	MA130 30-300-3000/3 (27 cm / Ø 7 cm)	0.5 A .. 30 A 0.5 A .. 300 A 0.5 A .. 3,000 A						3 V AC				100 mV/A 10 mV/A 1 mV/A		●	10 Hz .. 20 kHz	≤ 1 %	P01120663	
 Chap. 7	MA200 30-300/3 (17 cm)	0.5 A .. 45 A peak 0.5 A .. 450 A peak						4.5 V peak				100 mV/A 10 mV/A					≤ 1 % + 0.3 A	P01120570
	MA200 30-300/3 (25 cm)	0.5 A .. 45 A peak 0.5 A .. 450 A peak						4.5 V peak				100 mV/A 10 mV/A			5 Hz .. 1 MHz	≤ 1 % + 0.3 A	P01120571	
	MA200 3000/3 (35 cm)	5 A .. 4,500 A peak						4.5 V peak				1 mV/A				≤ 1 % + 0.3 A	P01120572	
 Chap. 8	A110 3-30-300-3000/3 (45 cm / Ø 14 cm)	0.08 A - 3 A 0.5 A .. 30 A 0.5 A .. 300 A 0.5 A .. 3,000 A						3 V AC	●			1 V/A 100 mV/A 10 mV/A 1 mV/A			●	10 Hz .. 10 kHz 10 Hz .. 20 kHz 10 Hz .. 20 kHz 10 Hz .. 20 kHz	≤ 1 %	P01120630
	A110 3-30-300-3000/3 (80 cm / Ø 25 cm)	0.5 A .. 30 A 0.5 A .. 300 A 0.5 A .. 3,000 A						3 V AC	●			100 mV/A 10 mV/A 1 mV/A			●	10 Hz .. 20 kHz	≤ 1 %	P01120631
	A110 30-300-3000-30000/3 (120 cm / Ø 38 cm)	0.5 A .. 30 A 0.5 A .. 300 A 0.5 A .. 3,000 A 0.5 A .. 30,000 A						3 V AC	●			100 mV/A 10 mV/A 1 mV/A 0.1 mV/A			●	10 Hz .. 5 kHz 10 Hz .. 20 kHz 10 Hz .. 20 kHz 10 Hz .. 20 kHz	≤ 1 %	P01120632
 Chap. 8	A130 30-300-3000/3 (80 cm / Ø 25 cm)	0.5 A .. 30 A 0.5 A .. 300 A 0.5 A .. 3,000 A						3 V AC				100 mV/A 10 mV/A 1 mV/A			●	10 Hz .. 20 kHz	≤ 1 %	P01120633

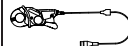
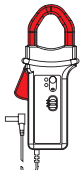

(1) The upper value corresponds to 120 % of the maximum rated value
 (3) Lead + electronic unit with Ø 4 mm safety connectors, centre distance: 19 mm, for K and AmpFlex®

Series	Model	Input				Output - Connections			Specific features					To order					
		Measuring range ⁽¹⁾				Current	Voltage	Lead + Ø 4 mm safety connectors ⁽³⁾	Ø 4 mm female sockets	BNC connector (coaxial)	Transformation ratio (input/output)	Output protected against voltage surges	Automatic DC voltage		Measurement of power (slight phase shift)	Bandwidth (frequency in Hz)	Typical accuracy		
		Very weak current	Weak current	Medium current	Strong current													AC	DC
 Chap. 9	K1	1 mA .. 4.5 A DC 1 mA .. 3 A _{RMS} 1 mA .. 4.5 A _{peak}				●	●			4.5 V AC 3 V _{RMS} 4.5 V _{peak}	●			1 mA / 1 mV			DC .. 2 kHz	≤ 1%	P01120067A
	K2	100 µA .. 450 mA DC 100 µA .. 300 mA _{RMS} 100 µA .. 450 mA _{peak}				●	●			4.5 V AC 3 V _{RMS} 4.5 V _{peak}	●			1 mA / 10 mV			DC .. 1.5 kHz	≤ 1%	P01120074A
 Chap. 10	E1N	0.05 A .. 2 A DC 0.05 A .. 1.5 A AC 0.5 A .. 150 A AC/DC				●	●			2 V DC 1.5 V AC 150 mV AC/DC	●			1 A / 1 V 1 A / 1 mV			DC .. 2 kHz DC .. 8 kHz	≤ 2% ≤ 1.5%	P01120030A
	E3N	0.05 A .. 10 A _{peak} 1 A .. 100 A _{peak}				●	●			1 V _{peak}		●		1 A / 100 mV 1 A / 10 mV			DC .. 100 kHz	≤ 3% ≤ 4%	P01120043A
	E6N	5 mA .. 2 A DC 5 mA .. 1.5 A AC 20 mA .. 80 A AC/DC				●	●			2 V DC 1.5 V AC 0.8 V AC/DC	●			1 A / 1 V 1 A / 10 mV			DC .. 2 kHz DC .. 8 kHz	≤ 2% ≤ 4%	P01120040A
 Chap. 11	MH60	0.01 A .. 140 A _{peak}				●	●			1.4 V _{peak}		●		10 mV/A			DC .. 1 MHz	≤ 1.5%	P01120612
 Chap. 12	PAC10	0.5 A .. 400 A AC 0.5 A .. 600 A DC				●	●			600 mV AC/DC	●			1 A / 1 mV			DC .. 5 kHz	≤ 2%	P01120070
	PAC11	0.2 A .. 40 A AC 0.4 A .. 60 A DC 0.5 A .. 400 A AC 0.5 A .. 600 A DC				●	●			600 mV AC/DC	●			1 A / 10 mV 1 A / 1 mV		●	DC .. 10 kHz	≤ 1.5% ≤ 2%	P01120068
	PAC12	0.2 A .. 60 A _{peak} 0.4 A .. 60 A DC 0.5 A .. 600 A _{peak} 0.5 A .. 600 A DC				●	●			600 mV _{peak}		●		1 A / 10 mV 1 A / 1 mV		●	DC .. 10 kHz	≤ 1.5% ≤ 2%	P01120072
 Chap. 12	PAC20	0.5 A .. 1,000 A AC 0.5 A .. 1,400 A DC				●	●			1.4 V AC/DC	●			1 A / 1 mV			DC .. 5 kHz	≤ 2%	P01120071
	PAC21	0.2 A .. 100 A AC 0.4 A .. 150 A DC 0.5 A .. 1,000 A AC 0.5 A .. 1,400 A DC				●	●			1.5 V AC/DC 1.4 V AC/DC	●			1 A / 10 mV 1 A / 1 mV		●	DC .. 10 kHz	≤ 1.5% ≤ 2.5%	P01120069
	PAC22	0.2 A .. 150 A _{peak} 0.4 A .. 150 A DC 0.5 A .. 1,400 A _{peak} 0.5 A .. 1,400 A DC				●	●			1.5 V _{peak} 1.4 V _{peak}		●		1 A / 10 mV 1 A / 1 mV		●	DC .. 10 kHz	≤ 1.5% ≤ 2.5%	P01120073

(1) The upper value corresponds to 120% of the maximum rated value
(3) Lead + electronic unit with Ø 4 mm safety connectors, centre distance 19 mm, for K and AmpFlex®

Series	Model	Input					Output - Connections				Specific features					To order
		Measuring range ⁽¹⁾					Current	Voltage	Lead + Ø 4 mm safety connectors ⁽³⁾	Ø 4 mm female sockets	BNC connector (coaxial)	Transformation ratio (input/output)	Output protected against voltage surges	Automatic DC voltage	Measurement of power (slight phase shift)	
Very weak current	Weak current	Medium current	Strong current	AC	DC											

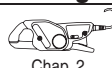
Leakage current measurement

 Chap. 2	MN73	10 mA .. 2,4 A 100 mA .. 240 A					2 V AC 2 V AC				1 A / 1,000 mV 1 A / 10 mV			40 Hz .. 10 kHz	≤ 1% ≤ 2%	P01120421
 Chap. 4	C173	1 mA .. 12 A 0.01 A .. 12 A 0.1 A .. 120 A 1 A .. 1,200 A					1 V AC				1 A / 1 V 10 A / 1 V 100 A / 1 V 1,000 A / 1 V			10 Hz .. 3 kHz	≤ 0.7% ≤ 0.3% ≤ 0.5% ≤ 0.2%	P01120309
 Chap. 6	B102	500 µA .. 4 A 0.5 A .. 400 A					4 V AC 0.4 V AC				1 mA / 1 mV 1 A / 1 mV			10 Hz .. 1 kHz	≤ 0.5% ≤ 0.35%	P01120083

Measurement on oscilloscope

 Chap. 2	MN60	0.1 A .. 60 A peak 0.5 A .. 600 A peak					6 V peak 6 V peak				1 A / 100 mV 1 A / 10 mV			40 Hz .. 40 kHz	≤ 2% ≤ 1.5%	P01120409
 Chap. 3	Y7N	1 A .. 1,200 A peak					1.2 V peak				1 mA / 1 mV			5 Hz .. 10 kHz	≤ 2%	P01120075
 Chap. 4	C160	0.1 A .. 30 A peak 1 A .. 300 A peak 1 A .. 2,000 A peak					3 V peak 3 V peak 2 V peak				10 A / 1 V 100 A / 1 V 1,000 A / 1 V			10 Hz .. 100 kHz	≤ 3% ≤ 2% ≤ 1%	P01120308
 Chap. 5	D38N	1 A .. 90 A peak 1 A .. 900 A peak 1 A .. 9,000 A peak					0.9 V peak				1 A / 10 mV 1 A / 1 mV 1 A / 0.1 mV			30 Hz .. 50 kHz	≤ 2%	P01120057A
 Chap. 10	E3N	0.05 A .. 10 A peak 1 A .. 100 A peak					1 V peak				1 A / 10 mV 1 A / 1 mV			DC .. 100 kHz	≤ 3% ≤ 4%	P01120043A
 Chap. 11	MH60	0.01 A .. 140 A peak					1.4 V peak				10 mV/A			DC .. 1 MHz	≤ 1.5%	P01120612
 Chap. 7	MA200 30-300/3 (17 cm / Ø 4.5 cm)	0.5 A .. 45 A peak 0.5 A .. 450 A peak					4.5 V peak				100 mV/A 10 mV/A			5 Hz .. 1 MHz	≤ 1% +0.3 A	P01120570
	MA200 30-300/3 (25 cm / 7 cm)	0.5 A .. 45 A peak 0.5 A .. 450 A peak					4.5 V peak				100 mV/A 10 mV/A			5 Hz .. 1 MHz	≤ 1% +0.3 A	P01120571
	MA200 3000/3 (35 cm / Ø 10 cm)	5 A .. 4,500 A peak					4.5 V peak				1 mV/A			5 Hz .. 1 MHz	≤ 1% +0.3 A	P01120572
 Chap. 12	PAC12	0.2 A .. 60 A peak 0.4 A .. 60 A DC 0.5 A .. 600 A peak 0.5 A .. 600 A DC					600 mV peak				1 A / 10 mV 1 A / 1 mV			DC .. 10 kHz	≤ 1.5% ≤ 2%	P01120072
 Chap. 12	PAC22	0.2 A .. 150 A peak 0.4 A .. 150 A DC 0.5 A .. 1,400 A peak 0.5 A .. 1,400 A DC					1.5 V peak 1.4 V peak				1 A / 10 mV 1 A / 1 mV			DC .. 10 kHz	≤ 1.5% ≤ 2.5%	P01120073

Measurement of process current

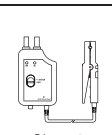
 Chap. 9	K1	1 mA .. 4.5 A DC 1 mA .. 3 A _{RMS} 1 mA .. 4.5 A peak					4.5 V DC 3 V _{RMS} 4.5 V peak				1 mA / 1 mV			DC .. 2 kHz	≤ 1%	P01120067A
	K2	100 µA .. 450 mA DC 100 µA .. 300 mA _{RMS} 100 µA .. 450 mA peak					4.5 V DC 3 V _{RMS} 4.5 V peak				1 mA / 10 mV			DC .. 1.5 kHz	≤ 1%	P01120074A

Measurement on secondary winding of current transformers

 Chap. 2	MN71	10 mA .. 12 A					1 V AC				1 A / 100 mV			40 Hz .. 10 kHz	≤ 1%	P01120420
--	------	---------------	--	--	--	--	--------	--	--	--	--------------	--	--	-----------------	------	-----------



MINI SERIES

Small, compact and particularly resistant, this range of miniature clamps is designed for measurements from a few milli-amperes to 150 A AC. Their shape makes them very practical in confined spaces, such as circuit-breaker boards, control panels or control boxes. They are ideal for use with multimeters.

There are two types of MINI clamps.

The first type operates like a traditional current transformer and provides a current output (mA) which can be used with multimeters, loggers or instruments with current calibres.

The second provides a voltage output proportional to the current measured. This voltage output enables instruments with AC voltage calibres to display or store current values.

There is also a model with a DC voltage output.

The MINI clamps give True RMS results when used with a True RMS instrument.

MINI 100 SERIES

Incorporating all the essentials which made the Miniclamps and the MINI 10 Series so successful, the MINI 100 Series completes the range with a clamping diameter of 16 mm.

The models in the MINI 100 Series are equipped with a so-called "direct reading" input/output ratio and can measure currents up to 350 A.



MINI SERIES

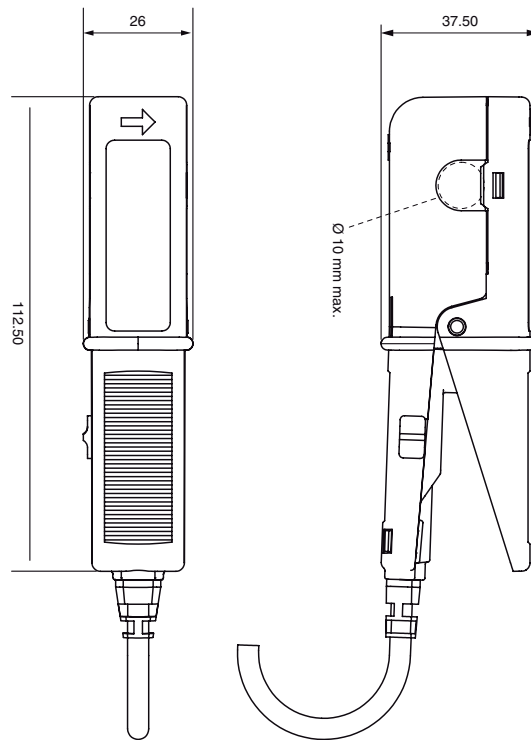

MINI 100 SERIES

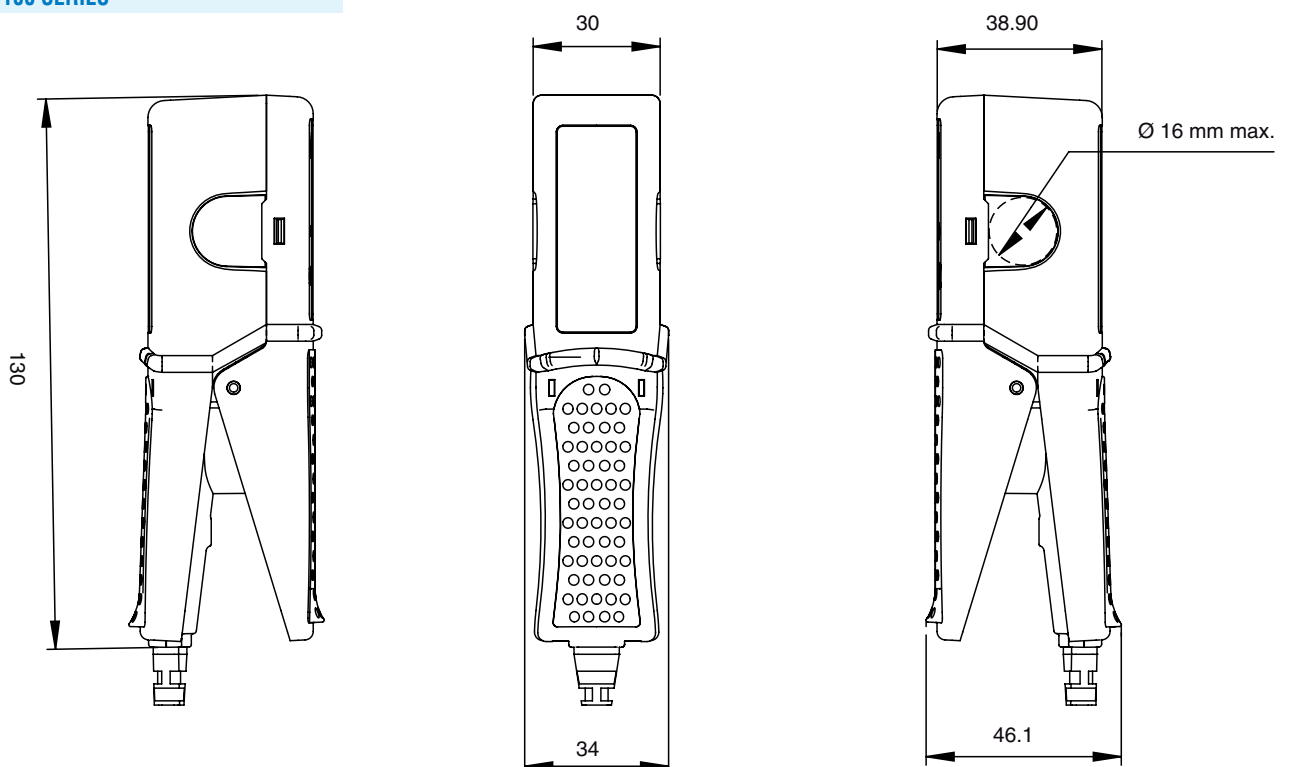

Current clamp for AC current

Model MINI 01

MINI series

Calibre	150 A AC
Sensitivity	1 mA/A (1000/1)

DESCRIPTION

Small and compact, the MINI 01 current clamp is the ideal complement for any multimeter to measure AC currents in low-power tertiary or industrial applications.

If there is a current in the conductor clamped, the MINI 01 clamp is protected against overvoltages during disconnection from the measurement instrument.

MAIN SPECIFICATIONS ⁽¹⁾

Calibre	150 A
Measurement range	2 A .. 150 A
Accuracy of primary current in %	≤ 2.5 % + 0.15 A (load 1 Ω) ≤ 3 % + 0.15 A (load 10 Ω)
Phase shift	not specified
Output signal	1 mA AC/A AC (1000/1) (150 mA for 150 A)



- **Output:**
Double-insulated cable 1.5 m long, terminated by 2 insulated elbowed male banana connectors Ø 4 mm
- **Bandwidth:**
48 Hz .. 500 Hz
- **Clamping capacity:**
Cable Ø max 10 mm

ELECTRICAL SPECIFICATIONS

- **Load impedance:**
≤ 10 Ω
- **Maximum currents:**
I < 150 A permanent from 48 Hz .. 500 Hz
- **Influence of temperature:**
≤ 0.2 % per 10 °K
- **Influence of adjacent conductor:**
≤ 2 mA/A at 50 Hz
- **Influence of conductor position in jaws:**
≤ 0.1 % at 50/60 Hz
- **Influence of frequency:**
≤ 2 % from 65 Hz to 500 Hz
- **Maximum output voltage (secondary open):**
30 V

MECHANICAL SPECIFICATIONS

- **Operating temperature:**
-10 °C to +50 °C
- **Storage temperature:**
-40 °C to +80 °C
- **Relative humidity for operation:**
From 0 to 85 % RH with a linear decrease above 35 °C
- **Operating altitude:**
0 to 2,000 m
- **Casing protection rating (leakproofing):**
IP40 ⁽²⁾ (EN 60529 Ed. 1992)
- **Drop test:**
1.5 m (IEC 68-2-32)
- **Shock resistance:**
100 g / 6 ms / half-period (IEC 68-2-27)
- **Vibration resistance ⁽³⁾:**
5-15 Hz (1.5 mm), 15-25 Hz (1 mm), 25-55 Hz (0.25 mm) (IEC 68-2-6)
- **Self-extinguishing capability:**
casing UL94 V2
- **Dimensions:**
130 x 37 x 25 mm
- **Weight:**
approx. 180 g
- **Colour:**
Black casing

SAFETY SPECIFICATIONS

- **Electrical safety:**
Instrument with double insulation or reinforced insulation between the primary, the secondary and the grippable part located under the guard as per EN 61010-1 Ed. 2:2001, EN 61010-2-031 Ed. 2002 & EN 61010-2-032 Ed. 2003
- 600 V category III, pollution degree 2
- 300 V category IV, pollution degree 2
- **Electromagnetic compatibility:**
CE-certified equipment compliant with standard EN 61326-1 (Ed. 97) + A1 (Ed. 98) + A2 (Ed. 01)
- Emission: stipulations for class B equipment (domestic use).
- Immunity: stipulations for equipment used intermittently on industrial sites.

(1) Conditions of reference: 23 °C ± 3 °K, 20 °C to 75 % RH, sinusoidal signal with frequency of 48 Hz to 65 Hz, distortion factor < 1 % with no DC component, external DC magnetic field < 40 A/m, no external AC magnetic field, no external conductor with circulating current, conductor centred for measurement, measurement instrument load impedance ≤ 10 Ω.

(2) With clamp closed.

(3) Vibrations expressed in mm peak, scanning of 1 octave/minute for 10 minutes on 3 axes.

To order	Reference
AC current clamp model MINI 01 with operating manual	P01105101Z

Current clamp for AC current

Model MINI 02

MINI series

Calibre	100 A AC
Sensitivity	1 mA/A (1000/1)

DESCRIPTION

The MINI 02 current clamp, whose jaws are equipped with a high-performance magnetic material and a double coil, offers excellent linearity and improved performance.

Small and compact, it is ideal for measuring AC currents in low-power tertiary or industrial applications.

If a current is present in the conductor being clamped, the MINI 02 clamp is protected against voltage surges when it is disconnected from the measurement instrument.



MAIN SPECIFICATIONS ⁽¹⁾

Calibre	100 A
Measurement range	50 mA .. 100 A (load 1 Ω) 50 mA .. 90 A (load 10 Ω)
Accuracy of primary current in % (48 Hz to 10 kHz)	≤ 1 % + 0.02 A (load 1 Ω) ≤ 1.5 % + 0.01 A (load 10 Ω)
Phase shift (50 Hz to 60 Hz)	≤ 3° (load 1 Ω) ≤ 6° (load 10 Ω)
Output signal	1 mA AC / A AC (1000/1) (100 mA for 100 A)

- **Output:**
Double-insulated cable 1.5 m long, terminated by 2 insulated elbowed male banana connectors Ø 4 mm
- **Bandwidth:**
48 Hz .. 10 000 Hz
- **Clamping capacity:**
Cable Ø max 10 mm

ELECTRICAL SPECIFICATIONS

- **Load impedance:**
≤ 100 Ω
- **Influence of load impedance:**
See curves
- **Maximum currents:**
I < 100 A permanent from 48 Hz .. 10,000 Hz
- **Influence of temperature:**
≤ 0.2 % per 10 °K
- **Influence of adjacent conductor:**
≤ 2 mA/A at 50 Hz
- **Influence of conductor position in jaws:**
≤ 0.1 % at 50/60 Hz
- **Influence of frequency:**
≤ 2 % from 65 Hz to 10 kHz
- **Maximum output voltage (secondary open):**
≤ 30 V

MECHANICAL SPECIFICATIONS

- **Operating temperature:**
-10 °C to +50 °C
- **Storage temperature:**
-40 °C to +80 °C
- **Relative humidity for operation:**
From 0 to 85 % RH with a linear decrease above 35 °C
- **Operating altitude:**
0 to 2,000 m
- **Casing protection rating (leakproofing):**
IP40 ⁽²⁾ (EN 60529 Ed. 1992)
- **Drop test:**
1.5 m (IEC 68-2-32)
- **Shock resistance:**
100 g / 6 ms / half-period (IEC 68-2-27)
- **Vibration resistance ⁽³⁾:**
5-15 Hz (1.5 mm), 15-25 Hz (1 mm), 25-55 Hz (0.25 mm) (IEC 68-2-6)
- **Self-extinguishing capability:**
Casing UL94 V2
- **Dimensions:**
130 x 37 x 25 mm
- **Weight:**
Approx. 180 g
- **Colour:**
Black casing

SAFETY SPECIFICATIONS

- **Electrical safety:**
Instrument with double insulation or reinforced insulation between the primary, the secondary and the grippable part located under the guard as per EN 61010-1 Ed. 2:2001, EN 61010-2-031 Ed. 2002 & EN 61010-2-032 Ed. 2003
- 600 V category III, pollution degree 2
- 300 V category IV, pollution degree 2
- **Electromagnetic compatibility:**
CE-certified equipment compliant with standard EN 61326-1 (Ed. 97) + A1 (Ed. 98) + A2 (Ed. 01)
- Emission: stipulations for class B equipment (domestic use).
- Immunity: stipulations for equipment used intermittently on industrial sites.

Current clamp for AC current

Model MINI 02

MINI series



CURVES AT 50 HZ

Typical linearity error for loads of 1, 10, 30 and 100 Ω

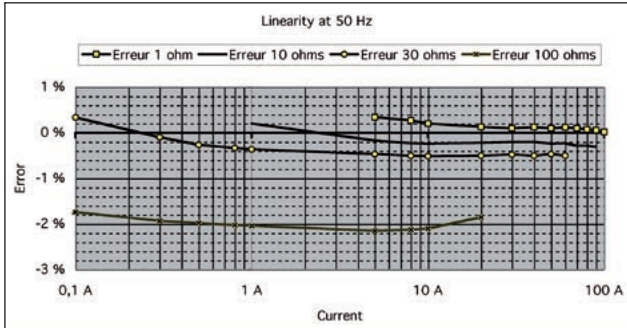

Typical phase shift for loads of 1, 10, 30 and 100 Ω

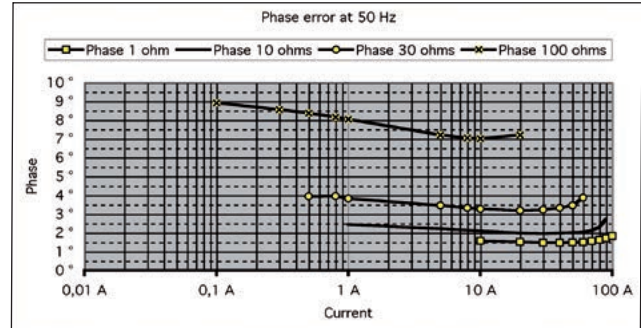

FREQUENCY RESPONSE AT 10 A

Typical linearity error for loads of 1, 10, 30 and 100 Ω

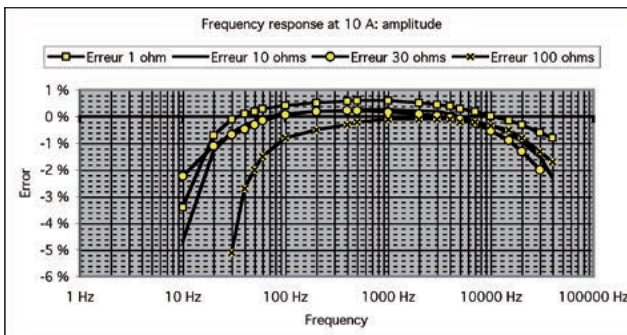

Typical phase shift for loads of 1, 10, 30 and 100 Ω

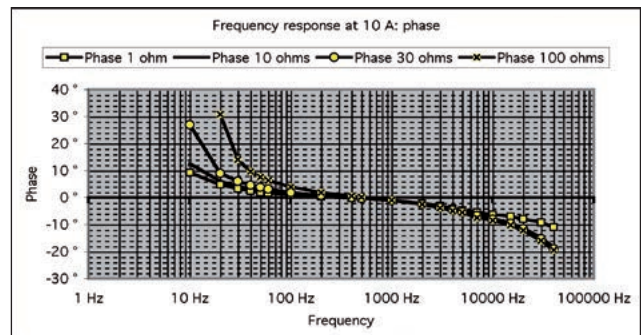

(1) Conditions of reference: 23°C \pm 3 °K, 20°C to 75% RH, sinusoidal signal with frequency of 48 Hz at 10 kHz, distortion factor < 1% with no DC component, external DC magnetic field < 40 A/m, no external AC magnetic field, no external conductor with circulating current, conductor centred for measurement, measurement instrument load impedance \leq 10 Ω .

(2) With clamp closed.

(3) Vibrations expressed in mm peak, scanning of 1 octave/minute for 10 minutes on 3 axes.

To order	Reference
AC current clamp model MINI 02 with operating manual	P01105102Z

Current clamp for AC current

Model MINI 03

MINI series

Calibre	100 A AC
Sensitivity	1 mV/A

DESCRIPTION

Small and compact, the MINI 03 current clamp is the ideal complement for any multimeter to measure AC currents in low-power tertiary or industrial applications.

When used with an AC voltmeter, it allows you to directly read the current measured on the voltmeter.

MAIN SPECIFICATIONS ⁽¹⁾

Calibre	100 A
Measurement range	1 A .. 100 A
Accuracy of primary current in %	≤ 2 % + 50 mA
Phase shift	not specified
Output signal	1 mV AC / A AC (100 mV for 100 A)



Output:

Double-insulated cable 1.5 m long, terminated by 2 insulated elbowed male banana connectors Ø 4 mm

Bandwidth:

48 Hz .. 500 Hz

Clamping capacity:

Cable Ø max 10 mm

ELECTRICAL SPECIFICATIONS

Maximum currents:

$I < 150$ A permanent from 48 Hz .. 500 Hz

Influence of temperature:

≤ 0.2 % per 10 °K

Influence of adjacent conductor:

≤ 2 mA/A at 50 Hz

Influence of conductor position in jaws:

≤ 0.1 % at 50/60 Hz

Influence of frequency:

≤ 1 % from 65 Hz to 500 Hz

MECHANICAL SPECIFICATIONS

Operating temperature:

-10 °C to +50 °C

Storage temperature:

-40 °C to +80 °C

Relative humidity for operation:

From 0 to 85 % RH with a linear decrease above 35 °C

Operating altitude:

0 to 2,000 m

Casing protection rating (leakproofing):

IP40 ⁽²⁾ (EN 60529 Ed. 1992)

Drop test:

1.5 m (IEC 68-2-32)

Shock resistance:

100 g / 6 ms / half-period (IEC 68-2-27)

Vibration resistance ⁽³⁾:

5-15 Hz (1.5 mm), 15-25 Hz (1 mm), 25-55 Hz (0.25 mm) (IEC 68-2-6)

Self-extinguishing capability:

Casing UL94 V2

Dimensions:

130 x 37 x 25 mm

Weight:

Approx. 180 g

Colour:

Black casing

SAFETY SPECIFICATIONS

Electrical safety:

Instrument with double insulation or reinforced insulation between the primary, the secondary and the grippable part located under the guard as per EN 61010-1 Ed. 2:2001, EN 61010-2-031 Ed. 2002 & EN 61010-2-032 Ed. 2003
- 600 V category III, pollution degree 2
- 300 V category IV, pollution degree 2

Electromagnetic compatibility:

CE-certified equipment compliant with standard EN 61326-1 (Ed. 97) + A1 (Ed. 98) + A2 (Ed. 01)
- Emission: stipulations for class B equipment (domestic use).
- Immunity: stipulations for equipment used intermittently on industrial sites.

(1) Conditions of reference: 23 °C ± 3 °K, 20 °C to 75 % RH, sinusoidal signal with frequency of 48 Hz to 65 Hz, distortion factor < 1 % with no DC component, external DC magnetic field < 40 A/m, no external AC magnetic field, no external conductor with circulating current, conductor centred for measurement, measurement instrument load impedance ≥ 10 kΩ.

(2) With clamp closed.

(3) Vibrations expressed in mm peak, scanning of 1 octave/minute for 10 minutes on 3 axes.

To order	Reference
AC current clamp model MINI 03 with operating manual	P01105103Z

Current clamp for AC current

Model MINI 05

MINI series

Calibre	10 A AC	100 A AC
Sensitivity	1 mV/mA	1 mV/A

DESCRIPTION

Small and compact, the MINI 05 current clamp is the ideal complement for any multimeter to measure AC currents in low-power tertiary or industrial applications.

With its 2 calibres, it offers excellent resolution for measuring AC currents from 5 mA to 100 A.

MAIN SPECIFICATIONS ⁽¹⁾

Calibre	10 A	100 A
Measurement range	5 mA .. 10 A	1 A .. 100 A
Accuracy of primary current in %	≤ 3 % + 0.15 mA	≤ 2 % + 50 mA
Phase shift	not specified	
Output signal	1 mVAC/mA AC (10 V for 10 A)	1 mVAC/A AC (100 mV for 100 A)

Output:

Double-insulated cable 1.5 m long, terminated by 2 insulated elbowed male banana connectors
Ø 4 mm

Bandwidth:

48 Hz .. 500 Hz

Clamping capacity:

Cable Ø max 10 mm

ELECTRICAL SPECIFICATIONS

Maximum currents:

■ 100 A calibre

I < 150 A permanent from 48 Hz .. 500 Hz

■ 10 A calibre

I < 15 A permanent from 48 Hz .. 500 Hz

Influence of temperature:

≤ 0.2 % per 10 °K

Influence of adjacent conductor:

≤ 2 mA/A at 50 Hz

Influence of conductor position in jaws:

≤ 0.1 % at 50/60 Hz

Influence of frequency:

■ 100 A calibre:

≤ 1 % from 65 Hz to 500 Hz

■ 10 A calibre:

≤ 3 % from 65 Hz to 500 Hz

MECHANICAL SPECIFICATIONS

Operating temperature:

-10 °C to +50 °C

Storage temperature:

-40 °C to +80 °C

Relative humidity for operation:

From 0 to 85 % RH with a linear decrease above 35 °C

Operating altitude:

0 to 2,000 m

Casing protection rating (leakproofing):

IP40 ⁽²⁾ (EN 60529 Ed. 1992)

Drop test:

1.5 m (IEC 68-2-32)

Shock resistance:

100 g / 6 ms / half-period (IEC 68-2-27)

Vibration resistance ⁽³⁾:

5-15 Hz (1.5 mm), 15-25 Hz (1 mm), 25-55 Hz (0.25 mm) (IEC 68-2-6)

Self-extinguishing capability:

casing UL94 V2

Dimensions:

130 x 37 x 25 mm

Weight:

Approx. 180 g

Colour:

Black casing

SAFETY SPECIFICATIONS

Electrical safety:

Instrument with double insulation or reinforced insulation between the primary, the secondary and the grippable part located under the guard as per EN 61010-1 Ed. 2:2001, EN 61010-2-031 Ed. 2002 & EN 61010-2-032 Ed. 2003
- 600 V category III, pollution degree 2
- 300 V category IV, pollution degree 2

Electromagnetic compatibility:

CE-certified equipment compliant with standard EN 61326-1 (Ed. 97) + A1 (Ed. 98) + A2 (Ed. 01)
- Emission: stipulations for class B equipment (domestic use).
- Immunity: stipulations for equipment used intermittently on industrial sites.



(1) Conditions of reference: 23 °C ± 3 °K, 20 °C to 75 % RH, sinusoidal signal with frequency of 48 Hz to 65 Hz, distortion factor < 1 % with no DC component, external DC magnetic field < 40 A/m, no external AC magnetic field, no external conductor with circulating current, conductor centred for measurement, measurement instrument load impedance ≥ 1 MΩ (10 A calibre) & ≥ 10 kΩ (100 A calibre).

(2) With clamp closed.

(3) Vibrations expressed in mm peak, scanning of 1 octave/minute for 10 minutes on 3 axes.

To order	Reference
AC current clamp model MINI 05 with operating manual	P01105105Z

Current clamp for AC current

Model MINI 09

MINI series

Calibre	150 A AC
Sensitivity	100 mVDC / A AC

DESCRIPTION

Small and compact, the MINI 09 current clamp is the ideal complement for any multimeter to measure AC currents in low-power tertiary or industrial applications.

Its DC voltage output helps to overcome the low sensitivity of certain AC measurement instruments.

MAIN SPECIFICATIONS ⁽¹⁾

Calibre	150 A			
Measurement range	1 A .. 5 A	5 A .. 15 A	15 A .. 40 A	40 A .. 150 A
Accuracy of primary current in %	≤ 10 % + 0.2 A	≤ 6 % + 0.2 A	≤ 3 % + 0.2 A	≤ 4 %
Phase shift	not specified			
Output signal	100 mVDC / A AC (15 VDC for 150 A)			

- **Output:**
Double-insulated cable 1.5 m long, terminated by 2 insulated elbowed male banana connectors Ø 4 mm
- **Bandwidth:**
48 Hz .. 500 Hz
- **Clamping capacity:**
Cable Ø max 10 mm

ELECTRICAL SPECIFICATIONS

- **Maximum currents:**
I < 150 A permanent from 65 Hz .. 500 Hz
- **Influence of temperature:**
≤ 0.2 % per 10 °K
- **Influence of adjacent conductor:**
≤ 2 mA/A at 50 Hz
- **Influence of conductor position in jaws:**
≤ 0.1 % at 50/60 Hz
- **Influence of frequency:**
≤ 3 % from 65 Hz to 500 Hz

MECHANICAL SPECIFICATIONS

- **Operating temperature:**
-10 °C to +50 °C
- **Storage temperature:**
-40 °C to +80 °C
- **Relative humidity for operation:**
0 to 85 % RH decreasing linearly above 35 °C
- **Operating altitude:**
0 to 2,000 m
- **Casing protection rating (leakproofing):**
IP40 ⁽²⁾ (EN 60529 Ed. 1992)
- **Drop test:**
1.5 m (IEC 68-2-32)
- **Shock resistance:**
100 g / 6 ms / half-period (IEC 68-2-27)
- **Vibration resistance ⁽³⁾:**
5-15 Hz (1.5 mm), 15-25 Hz (1 mm), 25-55 Hz (0.25 mm) (IEC 68-2-6)
- **Self-extinguishing capability:**
Casing UL94 V2
- **Dimensions:**
130 x 37 x 25 mm
- **Weight:**
Approx. 180 g
- **Colour:**
Black casing

SAFETY SPECIFICATIONS

- **Electrical safety:**
Instrument with double insulation or reinforced insulation between the primary, the secondary and the grippable part located under the guard as per EN 61010-1 Ed. 2:2001, EN 61010-2-031 Ed. 2002 & EN 61010-2-032 Ed. 2003
- 600 V category III, pollution degree 2
- 300 V category IV, pollution degree 2
- **Electromagnetic compatibility:**
CE-certified equipment compliant with standard EN 61326-1 (Ed. 97) + A1 (Ed. 98) + A2 (Ed. 01)
- Emission: stipulations for class B equipment (domestic use).
- Immunity: stipulations for equipment used intermittently on industrial sites.



(1) Conditions of reference: 23 °C ± 3 °K, 20 % to 75 % RH, sinusoidal signal with frequency of 48 Hz to 65 Hz, distortion factor < 1 % with no DC component, external DC magnetic field < 40 A/m, no external AC magnetic field, no external conductor with circulating current, conductor centred for measurement, measurement instrument load impedance ≥ 50 kΩ.

(2) With clamp closed.

(3) Vibrations expressed in mm peak, scanning of 1 octave/minute for 10 minutes on 3 axes.

To order	Reference
AC current clamp model MINI 09 with operating manual	P01105109Z

Current clamp for AC current

Model MINI 102

MINI 100 series



Calibre	200 A AC
Sensitivity	1 mA/A (1000/1)

DESCRIPTION

The MINI 102 current clamp, whose jaws are equipped with a high-performance magnetic material and a double coil, offer excellent linearity and improved performance.

If a current is present in the clamped conductor, the MINI 102 clamp is protected against voltage surges when it is connected to the measuring instrument.

MAIN SPECIFICATIONS (1)

Calibre	200 A
Measurement range	50 mA .. 200 A (load 1 Ω) 50 mA .. 200 A (load 10 Ω) 50 mA .. 20 A (load 100 Ω)
Accuracy in %	≤ 1% + 0.02 A (load 1 Ω) ≤ 1.5% + 0.01 A (load 10 Ω) ≤ 4% + 0.01 A (load 100 Ω)
Phase shift	≤ 3° (load 1 Ω) ≤ 6° (load 10 Ω) ≤ 12° (load 100 Ω)
Output signal	1 mA AC / A AC (1000/1) (200 mA for 200 A)



- **Output:**
Double-insulated cable 1.5 m long, terminated by 2 insulated elbowed male banana connectors Ø 4 mm
- **Bandwidth:**
48 Hz .. 10 000 Hz
- **Clamping capacity:**
Cable Ø max 16 mm

ELECTRICAL SPECIFICATIONS

- **Load impedance:**
≤ 100 Ω
- **Influence of load impedance:**
See curves
- **Maximum currents:**
350 A permanent at a frequency ≤ 1 kHz.
200 A permanent at a frequency ≤ 8 kHz
(limitation proportional to the reciprocal of the frequency beyond that)
- **Influence of temperature:**
≤ 0.2% per 10 °K
- **Influence of adjacent conductor:**
≤ 2 mA/A at 50 Hz
- **Influence of conductor position in jaws:**
≤ 0.08% at 50/60 Hz
- **Influence of frequency:**
≤ 1% typique
- **Maximum output voltage (secondary open):**
≤ 30 V

MECHANICAL SPECIFICATIONS

- **Operating temperature:**
-10 °C to +50 °C
- **Storage temperature:**
-40 °C to +80 °C
- **Relative humidity for operation:**
From 0 to 85% RH with a linear decrease above 35 °C
- **Operating altitude:**
0 to 2,000 m
- **Casing protection rating (leakproofing):**
IP20 (2) (EN 60529 Ed. 2001)
- **Drop test:**
1 m (IEC 68-2-32)
- **Dimensions:**
130.4 x 46 x 34 mm
- **Weight:**
approx. 250 g
- **Colour:**
Black casing

SAFETY SPECIFICATIONS

- **Electrical safety:**
Instrument with double insulation or reinforced insulation between the primary, the secondary and the grippable part located under the guard as per EN 61010-1 Ed. 2:2001, EN 61010-2-031 Ed. 2002 & EN 61010-2-032 Ed. 2003
- 600 V category III, pollution degree 2
- 300 V category IV, pollution degree 2
- **Electromagnetic compatibility:**
CE-certified equipment compliant with standard EN 61326-1:2006
- Emission: stipulations for class B equipment (domestic use).
- Immunity: stipulations for equipment used intermittently on industrial sites.

Current clamp for AC current

Model MINI 102

MINI 100 series



CURVES AT 50 Hz

Typical linearity error for loads of 1, 10 and 100 Ω

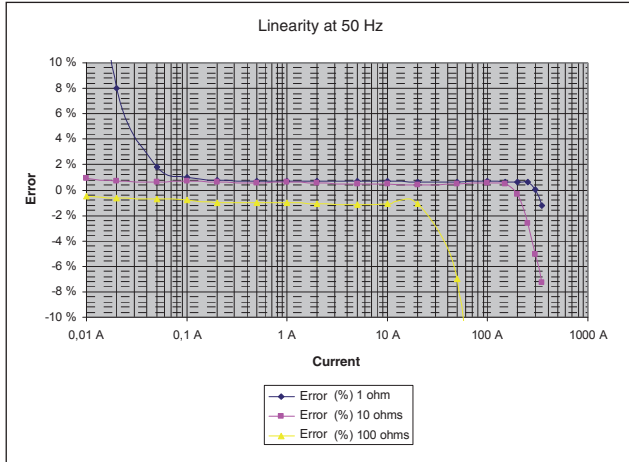

Typical phase shift for loads of de 1, 10, 30 and 100 Ω

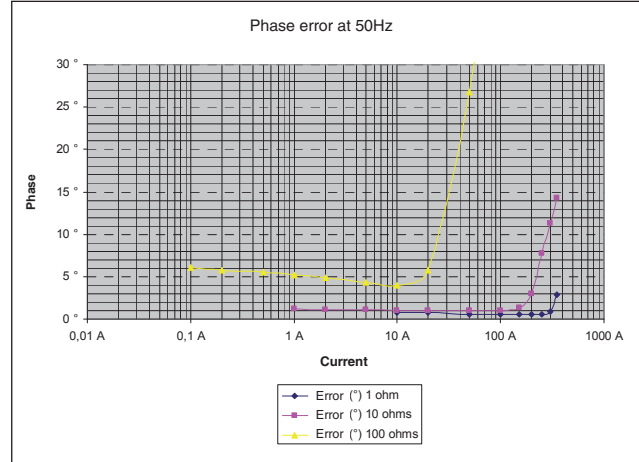

FREQUENCY RESPONSE AT 10 A

Typical linearity error for loads of 1, 10 and 100 Ω

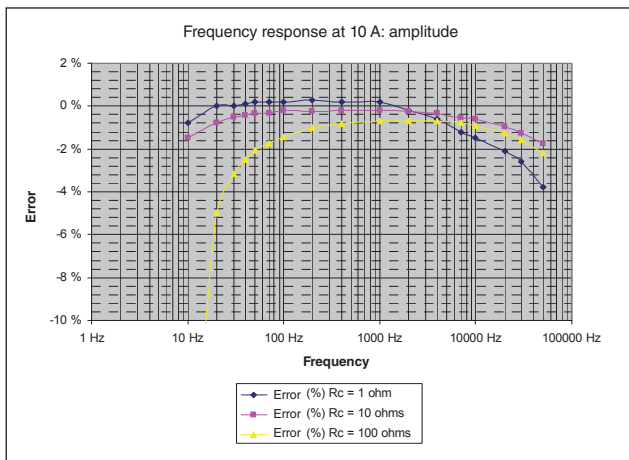

Typical phase shift for loads of 1, 10 and 100 Ω

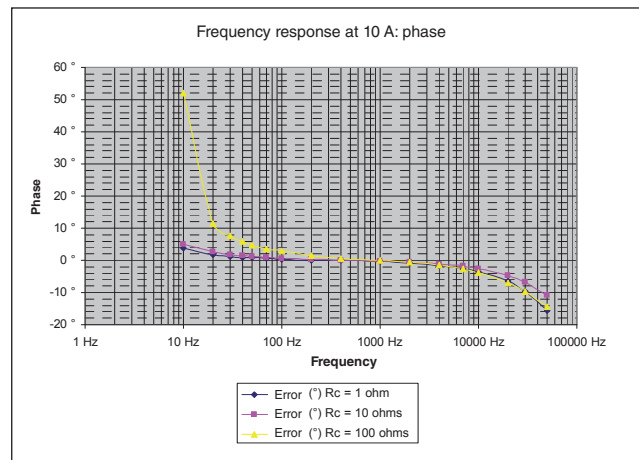

(1) Conditions of reference: 23°C \pm 3 °K, 20 °C to 75 % RH, sinusoidal signal with frequency of 48 Hz at 10 kHz, distortion factor < 1 % with no DC component, external DC magnetic field < 40 A/m, no external AC magnetic field, no external conductor with circulating current, conductor centred for measurement, measurement instrument load impedance \leq 10 Ω .

(2) With clamp closed.

To order	Reference
AC current clamp model MINI 102 with operating manual	P01106102

Current clamp for AC current

Model MINI 103

MINI 100 series

Calibre	200 A AC
Sensitivity	1 mV/A

DESCRIPTION

The MINI 103 current clamp is the ideal companion for any multimeter to measure AC currents in tertiary or industrial applications. When used with an AC voltmeter, it enables you to read the current measured directly on the voltmeter.

MAIN SPECIFICATIONS (*)

Calibre	200 A
Measurement range	0.1 A .. 200 A AC
Accuracy in %	$\leq 1.5\% + 0.02\text{ A}$
Phase shift	$\leq 3^\circ$
Output signal	1 mV AC/A AC (200 mV for 200 A)



- **Output:**
Double-insulated cable 1.5 m long, terminated by 2 insulated elbowed male banana connectors \varnothing 4 mm
- **Bandwidth:**
48 Hz .. 10 000 Hz
- **Clamping capacity:**
Cable \varnothing max 16 mm

ELECTRICAL SPECIFICATIONS

- **Load impedance:**
 $\geq 10\text{ k}\Omega$
- **Influence of load impedance:**
See curves
- **Maximum currents:**
350 A permanent at a frequency $\leq 1\text{ kHz}$.
200 A permanent at a frequency $\leq 8\text{ kHz}$
(limitation proportional to the reciprocal of the frequency beyond that)
- **Influence of temperature:**
 $\leq 0.2\%$ per 10°K
- **Influence of adjacent conductor:**
 $\leq 2\text{ mA/A}$ at 50 Hz
- **Influence of conductor position in jaws:**
 $\leq 0.08\%$ at 50/60 Hz
- **Influence of frequency:**
 $\leq 1\%$ typique

MECHANICAL SPECIFICATIONS

- **Operating temperature:**
 -10°C to $+50^\circ\text{C}$
- **Storage temperature:**
 -40°C to $+80^\circ\text{C}$
- **Relative humidity for operation:**
From 0 to 85 % RH with a linear decrease above 35°C
- **Operating altitude:**
0 to 2,000 m
- **Casing protection rating (leakproofing):**
IP20 (2) (EN 60529 Ed. 2001)
- **Drop test:**
1 m (IEC 68-2-32)
- **Dimensions:**
130.4 x 46 x 34 mm
- **Weight:**
approx. 250 g
- **Colour:**
Black casing

SAFETY SPECIFICATIONS

- **Electrical safety:**
Instrument with double insulation or reinforced insulation between the primary, the secondary and the grippable part located under the guard as per EN 61010-1 Ed. 2:2001, EN 61010-2-031 Ed. 2002 & EN 61010-2-032 Ed. 2003
- 600 V category III, pollution degree 2
- 300 V category IV, pollution degree 2
- **Electromagnetic compatibility:**
CE-certified equipment compliant with standard EN 61326-1: 2006
- Emission: stipulations for class B equipment (domestic use).
- Immunity: stipulations for equipment used intermittently on industrial sites.

Current clamp for AC current

Model MINI 103

MINI 100 series



CURVES AT 50 Hz

Typical linearity error

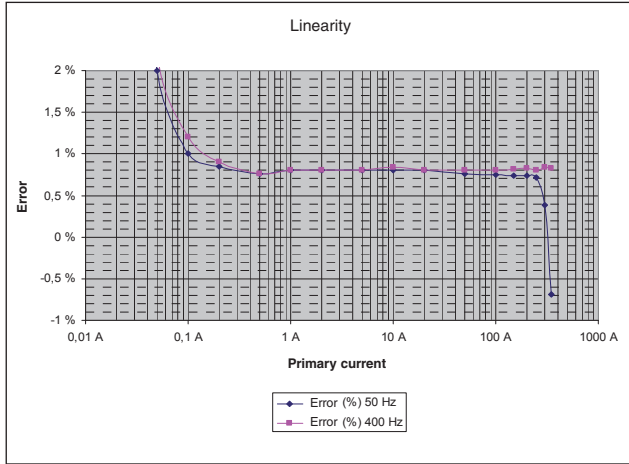

Typical phase shift

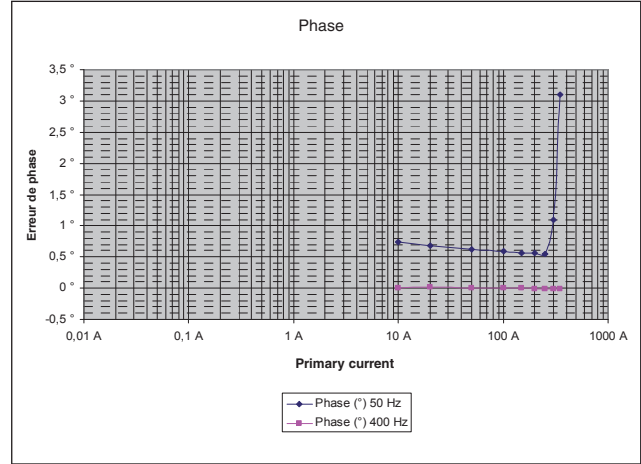

FREQUENCY RESPONSE

Typical linearity error

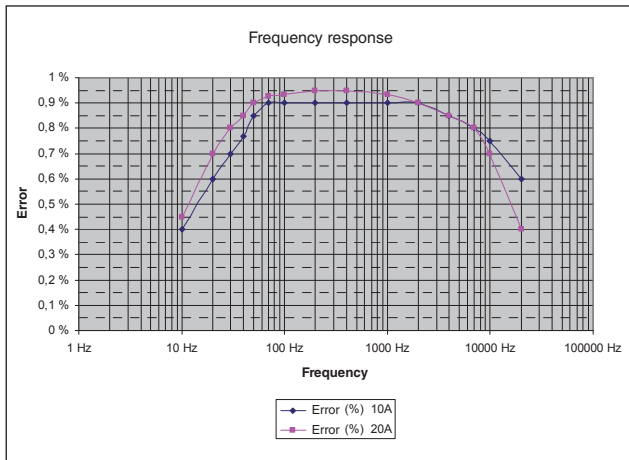

Typical phase shift

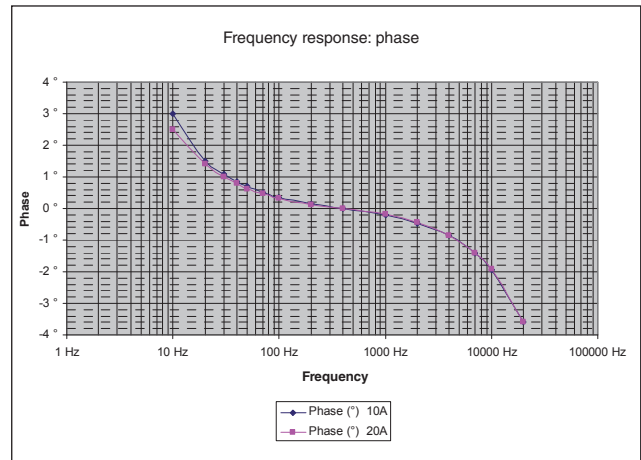

(1) Conditions of reference: 23°C ± 3 °K, 20 °C to 75 % RH, sinusoidal signal with frequency of 48 Hz at 65 Hz, distortion factor < 1 % with no DC component, external DC magnetic field < 40 A/m, no external AC magnetic field, no external conductor with circulating current, conductor centred for measurement, measurement instrument load impedance ≥ 10 kΩ.
 (2) With clamp closed.

To order	Reference
AC current clamp model MINI 103 with operating manual	P01106103



MN SERIES

These ergonomic mini-clamps are designed to make light work of measuring low and medium currents from 0.01 A to 240 A AC.

The shape of the jaws makes 'hooking' onto cables easy, even in areas of restrictive access. The jaws can grip conductors up to 20 mm in diameter.

Depending on the particular model, they have one or two calibres. The output is via either jack sockets or a lead with 4 mm Ø plugs, hence these clamps are compatible with all multimeters and testers on the market.

There are two types of MN series clamps available. The first kind operates as a current transformer (ratio 1,000/1) and gives a current output (mA) for use with any tester with current calibres.

The second type gives a voltage output (DC or AC depending on the model) proportional to the measured current (1, 10, 100 or 1,000 mV/A). This voltage output means that, even with testers without any current calibres, it is possible to measure currents by means of the DC or AC voltage calibres.

There are specific models in the MN series that have been designed with particular applications in mind such as measurement on current transformer outputs, on oscilloscopes and even of leakage currents.

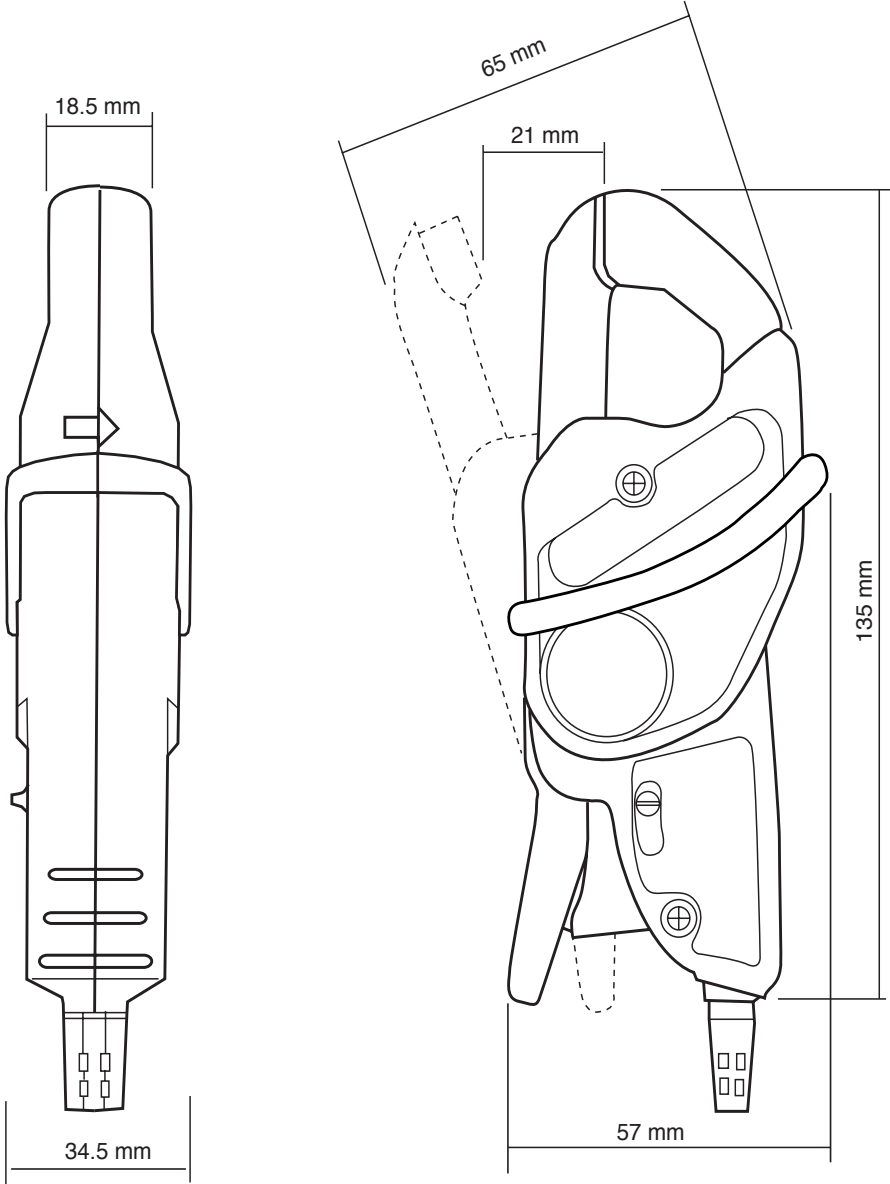

Current clamps for AC current

Models MN08 and MN09

MN series

Current	200 A AC
Ratio	1000/1
Output	1 mA/A

ELECTRICAL SPECIFICATIONS

- **Current range:**
0.5 A AC .. 240 A AC
- **Current transformation ratio:**
1000/1
- **Output signal:**
1 mA AC / A AC (240 mA for 240 A)
- **Accuracy and phase shift ⁽¹⁾:**

Primary current	0.5 A .. 10 A	10 A .. 40 A	40 A .. 100 A	100 A .. 240 A
% Accuracy of output signal	≤ 3 % + 0.5 mA	≤ 2.5 % + 0.5 mA	≤ 2 % + 0.5 mA	≤ 1 % + 0.5 mA
Phase shift	not specified	≤ 5°	≤ 3°	≤ 2.5°

- **Bandwidth:**
40 Hz .. 10 kHz
- **Crest factor:**
3 for a current of 200 A_{RMS}
- **Maximum currents:**
200 A continuous for a frequency ≤ 3 kHz (limitation proportional to the inverse of one third of frequency beyond)
- **Load impedance:**
≤ 10 Ω
- **Operating voltage:**
600 V_{RMS}
- **Common mode voltage:**
600 V category III and pollution degree 2
- **Influence of adjacent conductor:**
≤ 15 mA/A at 50 Hz
- **Influence of conductor position in jaws:**
≤ 0.5 % of output signal at 50/60 Hz
- **Load influence: 0.2 .. 10 Ω**
< 0.5 % on measurement
< 0.5° on phase
- **Influence of frequency ⁽²⁾:**
< 3 % of output signal from 40 Hz .. 1 kHz
< 12 % of output signal from 1 kHz .. 10 kHz
- **Influence of crest factor:**
< 4 % of output signal for a crest factor of 3 and current 200 of A_{RMS}

MECHANICAL SPECIFICATIONS

- **Operating temperature:**
-10 °C to +55 °C
- **Storage temperature:**
-40 °C to +70 °C
- **Influence of temperature:**
≤ 0.15 % of output signal per 10 °K
- **Relative humidity for operation:**
0 to 85 % RH decreasing linearly above 35 °C
- **Influence of relative humidity:**
< 0.2 % of output signal from 10 % to 85 % RH
- **Operating altitude:**
0 to 2,000 m
- **Max. jaw opening:**
20 mm
- **Clamping capacity:**
Cable: Ø max 20 mm
Busbar: 1 busbar of 20 x 5 mm
- **Casing protection rating:**
IP40 (IEC 529)
- **Drop test:**
1 m (IEC 68-2-32)
- **Shock resistance:**
100 g (IEC 68-2-27)
- **Vibration resistance:**
10/55/10 Hz, 0.15 mm (IEC 68-2-6)
- **Self-extinguishing capability:**
Casing: UL94 V2
Jaws: UL94 V0

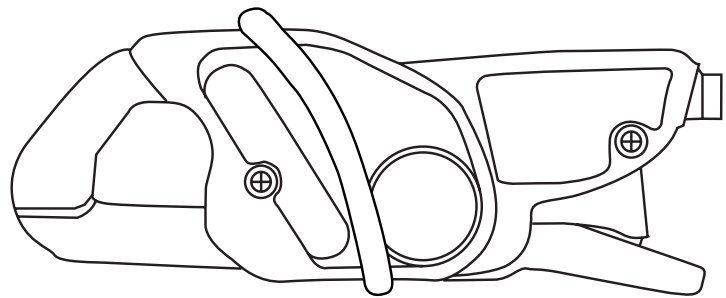

- **Dimensions:**
135 x 51 x 30 mm
- **Weight:**
180 g
- **Colours:**
Dark grey case with red jaws
- **Output:**
MN08:
Safety sockets (4 mm)
MN09:
1.5 m two-wire lead with double or reinforced insulation terminated by 2 elbowed male safety plugs (4 mm)

SAFETY SPECIFICATIONS

- **Electrical safety:**
Instrument with double insulation or reinforced insulation between the primary, the secondary and the grippable part located under the guard as per IEC 1010-1 & IEC 1010-2-032.
- 600 V category III, pollution degree 2
- 300 V category IV, pollution degree 2
- **Electromagnetic compatibility (EMC):**
EN 50081-1: class B
EN 50082-2:
- Electrostatic discharge: IEC 1000-4-2
- Radiated field: IEC 1000-4-3
- Fast transients: IEC 1000-4-4
- Magnetic field at 50/60 Hz: IEC 1000-4-8

(1) Conditions of reference: 23 °C ± 3 °K, 20 to 70 % RH, sinusoidal signal with frequency of 48 Hz to 65 Hz, external magnetic field < 40 A/m, no DC components, no external conductor with circulating current, conductor centred for measurement, 1 Ω load.

(2) Out of reference domain.

To order	Reference
AC current clamp model MN08 with operating manual	P01120401
AC current clamp model MN09 with operating manual	P01120402

Models MN10 and MN11

Current	200 A AC
Ratio	1000/1
Output	1 mA/A

DESCRIPTION

An electronic voltage-limiting system protects output of clamp when operating, if the secondary circuit is opened.

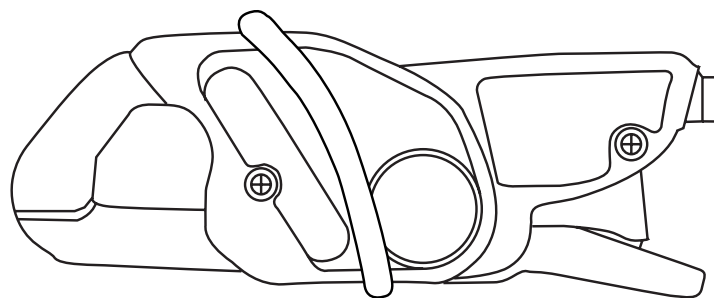

ELECTRICAL SPECIFICATIONS

- Current range:**
0.5 A AC .. 240 A AC
- Current transformation ratio:**
1000/1
- Output signal:**
1 mA AC / A AC (240 mA for 240 A)
- Accuracy and phase shift (1):**

Primary current	0.5 A .. 10 A	10 A .. 40 A	40 A .. 100 A	100 A .. 150 A	150 A .. 200 A	200 A .. 240 A
Accuracy in % of output signal	≤ 3 % + 0.5 mA	≤ 2.5 % + 0.5 mA	≤ 2 % + 0.5 mA	≤ 1 % + 0.5 mA	≤ 2 % + 0.5 mA	≤ 3 % + 0.5 mA
Phase shift	not specified	≤ 5°	≤ 3°	≤ 2.5°	≤ 2.5°	≤ 2.5°

- Bandwidth:**
40 Hz .. 10 kHz
- Crest factor:**
3 for a current of 200 A_{RMS}
- Maximum currents:**
200 A continuous for a frequency ≤ 3 kHz (limitation proportional to the inverse of one third of frequency beyond)
- Load impedance:**
≤ 10 Ω
- Maximum output voltage (secondary open):**
Limited to 8 V peak max.
- Operating voltage:**
600 V_{RMS}
- Common mode voltage:**
600 V category III and pollution degree 2
- Influence of adjacent conductor:**
≤ 15 mA/A at 50 Hz
- Influence of conductor position in jaws:**
≤ 0.5 % of output signal at 50/60 Hz
- Load influence:** 0.2 .. 10 Ω
< 0.5 % on measurement
< 0.5° on phase
- Influence of frequency (2):**
< 3 % of output signal from 40 Hz .. 1 kHz
< 12 % of output signal from 1 kHz .. 10 kHz
- Influence of crest factor:**
< 4 % of output signal for a crest factor of 3 and current of 200 A_{RMS}

MECHANICAL SPECIFICATIONS

- Operating temperature:**
-10 °C to +55 °C
- Storage temperature:**
-40 °C to +70 °C
- Influence of temperature:**
≤ 0.15 % of output signal per 10 °K
- Relative humidity for operation:**
0 to 85 % RH decreasing linearly above 35 °C
- Influence of relative humidity:**
< 0.2 % of output signal from 10 % to 85 % RH
- Operating altitude:**
0 to 2,000 m
- Max. jaw opening:**
20 mm
- Clamping capacity:**
Cable: Ø max 20 mm
Busbar: 1 busbar of 20 x 5 mm
- Casing protection rating:**
IP40 (IEC 529)
- Drop test:**
1 m (IEC 68-2-32)
- Shock resistance:**
100 g (IEC 68-2-27)
- Vibration resistance:**
10/55/10 Hz, 0.15 mm (IEC 68-2-6)
- Self-extinguishing capability:**
Casing: UL94 V2
Jaws: UL94 V0

- Dimensions:**
135 x 51 x 30 mm
- Weight:**
180 g
- Colours:**
Dark grey case with red jaws
- Output:**
MN10:
Safety sockets (4 mm)
MN11:
1.5 m two-wire lead with double or reinforced insulation terminated by 2 elbowed male safety plugs (4 mm)

SAFETY SPECIFICATIONS

- Electrical safety:**
Instrument with double insulation or reinforced insulation between the primary, the secondary and the grippable part located under the guard as per IEC 1010-1 & IEC 1010-2-032
- 600 V category III, pollution degree 2
- 300 V category IV, pollution degree 2
- Electromagnetic compatibility (EMC):**
EN 50081-1: class B
EN 50082-2:
- Electrostatic discharge: IEC 1000-4-2
- Radiated field: IEC 1000-4-3
- Fast transients: IEC 1000-4-4
- Magnetic field at 50/60 Hz: IEC 1000-4-8

(1) Conditions of reference: 23 °C ± 3 °K, 20 to 70 % RH, sinusoidal signal with frequency of 48 Hz to 65 Hz, external magnetic field < 40 A/m, no DC components, no external conductor with circulating current, conductor centred for measurement, 1 Ω load.

(2) Out of reference domain.

To order	Reference
AC current clamp model MN10 with operating manual	P01120403
AC current clamp model MN11 with operating manual	P01120404

Current clamps for AC current

Models MN12 and MN13

MN series

Current	200 A AC
Output	10 mV/A

ELECTRICAL SPECIFICATIONS

- **Current range:**
0.5 A AC .. 240 A AC
- **Output signal:**
10 mV AC / A AC (2.4 V for 240 A)
- **Accuracy and phase shift ⁽¹⁾:**

Primary current	0.5 A .. 10 A	10 A .. 40 A	40 A .. 100 A	100 A .. 240 A
% Accuracy of output signal	≤ 3.5 % + 5 mV	≤ 2.5 % + 5 mV	≤ 2 % + 5 mV	≤ 1 % + 5 mV
Phase shift	not specified	≤ 5°	≤ 3°	≤ 2.5°

- **Bandwidth:**
40 Hz .. 10 kHz
- **Crest factor:**
3 for a current of 200 A_{RMS}
- **Maximum currents:**
200 A continuous for a frequency ≤ 1 kHz (derating proportional to the inverse of frequency beyond)
- **Load impedance:**
> 1 MΩ
- **Operating voltage:**
600 V_{RMS}
- **Common mode voltage:**
600 V category III and pollution degree 2
- **Influence of adjacent conductor:**
≤ 15 mA/A at 50 Hz
- **Influence of conductor position in jaws:**
≤ 0.5 % of output signal at 50/60 Hz
- **Influence of frequency ⁽²⁾:**
< 3 % of output signal from 40 Hz .. 1 kHz
< 12 % of output signal from 1 kHz .. 10 kHz
- **Influence of crest factor:**
< 3 % of output signal for a crest factor of 3 and current of 200 A_{RMS}

MECHANICAL SPECIFICATIONS

- **Operating temperature:**
-10 °C to +55 °C
- **Storage temperature:**
-40 °C to +70 °C
- **Influence of temperature:**
≤ 0.15 % of output signal per 10 °K
- **Relative humidity for operation:**
0 to 85 % RH decreasing linearly above 35 °C
- **Influence of relative humidity:**
< 0.2 % of output signal from 10 % to 85 % RH
- **Operating altitude:**
0 to 2,000 m
- **Max. jaw opening:**
20 mm
- **Clamping capacity:**
Cable: Ø max 20 mm
Busbar: 1 busbar of 20 x 5 mm
- **Casing protection rating:**
IP40 (IEC 529)
- **Drop test:**
1 m (IEC 68-2-32)
- **Shock resistance:**
100 g (IEC 68-2-27)
- **Vibration resistance:**
10/55/10 Hz, 0.15 mm (IEC 68-2-6)
- **Self-extinguishing capability:**
Casing: UL94 V2
Jaws: UL94 V0

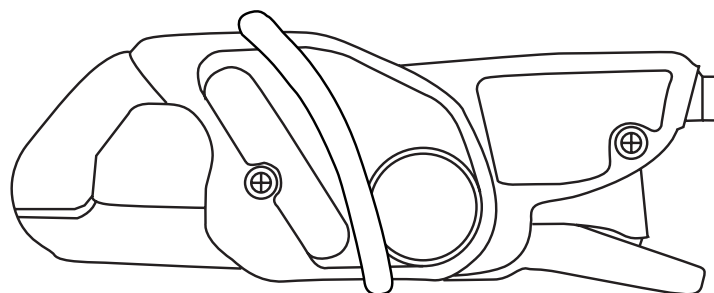

- **Dimensions:**
135 x 51 x 30 mm
- **Weight:**
180 g
- **Colours:**
Dark grey case with red jaws
- **Output:**
MN12:
Safety sockets (4 mm)
MN13:
1.5 m two-wire lead with double or reinforced insulation terminated by 2 elbowed male safety plugs (4 mm)

SAFETY SPECIFICATIONS

- **Electrical safety:**
Instrument with double insulation or reinforced insulation between the primary, the secondary and the grippable part located under the guard as per IEC 1010-1 & IEC 1010-2-032
- 600 V category III, pollution degree 2
- 300 V category IV, pollution degree 2
- **Electromagnetic compatibility (EMC):**
EN 50081-1: class B
EN 50082-2:
- Electrostatic discharge: IEC 1000-4-2
- Radiated field: IEC 1000-4-3
- Fast transients: IEC 1000-4-4
- Magnetic field at 50/60 Hz: IEC 1000-4-8

(1) Conditions of reference: 23 °C ± 3 °K, 20 to 70 % RH, sinusoidal signal with frequency of 48 Hz to 65 Hz, external magnetic field < 40 A/m, no DC components, no external conductor with circulating current, conductor centred for measurement, load impedance > 1 MΩ.

(2) Out of reference domain

To order	Reference
AC current clamp model MN12 with operating manual	P01120405
AC current clamp model MN13 with operating manual	P01120406

Models MN14 and MN15

Current	200 A AC
Output	1 mV/A

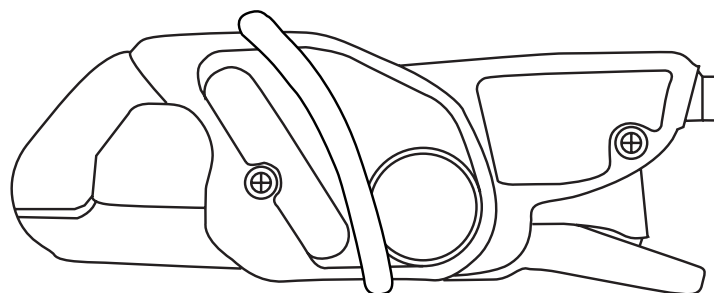

ELECTRICAL SPECIFICATIONS

- **Current range:**
0.5 A AC .. 240 A AC
- **Output signal:**
1 mVAC/A AC (240 mV for 240 A)
- **Accuracy and phase shift ⁽¹⁾:**

Primary current	0.5 A .. 10 A	10 A .. 40 A	40 A .. 100 A	100 A .. 240 A
% Accuracy of output signal	≤ 3 % + 5 mV	≤ 2.5 % + 5 mV	≤ 2 % + 5 mV	≤ 1 % + 5 mV
Phase shift	not specified	≤ 5 °	≤ 3 °	≤ 2.5 °

- **Bandwidth:**
40 Hz .. 10 kHz
- **Crest factor:**
3 for a current of 200 A_{RMS}
- **Maximum currents:**
200 A continuous for a frequency ≤ 1 kHz (limitation proportional to the inverse of frequency beyond)
- **Load impedance:**
> 1 MΩ
- **Operating voltage:**
600 V_{RMS}
- **Common mode voltage:**
600 V category III and pollution degree 2
- **Influence of adjacent conductor:**
≤ 15 mA/A at 50/60 Hz
- **Influence of conductor position in jaws:**
≤ 0.5 % of output signal at 50/60 Hz
- **Influence of frequency ⁽²⁾:**
< 3 % of output signal from 40 Hz .. 1 kHz
< 12 % of output signal from 1 kHz .. 10 kHz
- **Influence of crest factor:**
< 3 % of output signal for a crest factor of 3 and current of 200 A_{RMS}

MECHANICAL SPECIFICATIONS

- **Operating temperature:**
-10 °C to +55 °C
- **Storage temperature:**
-40 °C to +70 °C
- **Influence of temperature:**
≤ 0.15 % of output signal per 10 °K
- **Relative humidity for operation:**
0 to 85 % RH decreasing linearly above 35 °C
- **Influence of relative humidity:**
< 0.2 % of output signal of 10 % at 90 % RH
- **Operating altitude:**
0 to 2,000 m
- **Max. jaw opening:**
20 mm
- **Clamping capacity:**
Cable: Ø max 20 mm
Busbar: 1 busbar of 20 x 5 mm
- **Casing protection rating:**
IP40 (IEC 529)
- **Drop test:**
1 m (IEC 68-2-32)
- **Shock resistance:**
100 g (IEC 68-2-27)
- **Vibration resistance:**
10/55/10 Hz, 0.15 mm (IEC 68-2-6)
- **Self-extinguishing capability:**
Casing: UL94 V2
Jaws: UL94 V0

- **Dimensions:**
135 x 51 x 30 mm
- **Weight:**
180 g
- **Colours:**
Dark grey case with red jaws
- **Output:**
MN14:
Safety sockets (4 mm)
MN15:
1.5 m two-wire lead with double or reinforced insulation terminated by 2 elbowed male safety plugs (4 mm)

SAFETY SPECIFICATIONS

- **Electrical safety:**
Instrument with double insulation or reinforced insulation between the primary, the secondary and the grippable part located under the guard as per IEC 1010-1 & IEC 1010-2-032
- 600 V category III, pollution degree 2
- 300 V category IV, pollution degree 2
- **Electromagnetic compatibility (EMC):**
EN 50081-1: class B
EN 50082-2:
- Electrostatic discharge: IEC 1000-4-2
- Radiated field: IEC 1000-4-3
- Fast transients: IEC 1000-4-4
- Magnetic field at 50 Hz: IEC 1000-4-8

(1) Conditions of reference: 23 °C ± 3 °K, 20 to 70 % RH, sinusoidal signal with frequency of 48 Hz to 65 Hz, external magnetic field < 40 A/m, no DC components, no external conductor with circulating current, conductor centred for measurement, load impedance > 1 MΩ.

(2) Out of reference domain

To order	Reference
AC current clamp model MN14 with operating manual	P01120416
AC current clamp model MN15 with operating manual	P01120417

Current clamp for AC current

Model MN21

MN series

Current	200 A AC
Ratio	1000/1
Output	1 mA/A

DESCRIPTION

An electronic voltage-limiting system protects output of clamp when operating, if the secondary circuit is opened.

ELECTRICAL SPECIFICATIONS

- Current range:**
0.1 A AC .. 240 A AC
- Current transformation ratio:**
1000/1
- Output signal:**
1 mA AC / A AC (240 mA for 240 A)
- Accuracy and phase shift ⁽¹⁾:**

Primary current	0.1 A .. 10 A	1 A .. 20 A	20 A .. 80 A	80 A .. 150 A	150 A .. 200 A
% Accuracy of output signal	≤ 2 % + 20 μA	≤ 1 % + 20 μA	≤ 1 %	≤ 2 %	≤ 4 %
Phase shift	not specified	≤ 2°	≤ 1.5°	≤ 1.5°	≤ 2°

- Bandwidth:**
40 Hz .. 10 kHz
- Crest factor:**
5 for a current of 280 A peak
- Maximum currents:**
200 A continuous for a frequency ≤ 3 kHz (limitation proportional to the inverse of one third of frequency beyond)
- Load impedance:**
≤ 10 Ω
- Maximum output voltage (secondary open):**
Limited to 8 V peak max.
- Operating voltage:**
600 V_{RMS}
- Common mode voltage:**
600 V category III and pollution degree 2
- Influence of adjacent conductor:**
≤ 15 mA/A at 50 Hz
- Influence of conductor position in jaws:**
≤ 0.5 % of output signal at 50/60 Hz
- Load influence:** 0.1 .. 5 Ω
< 0.5 % on measurement
< 0.5° on phase
- Influence of frequency $I_p < 150 A$ ⁽²⁾:**
< 5 % of output signal from 40 Hz .. 1 kHz
< 15 % of output signal from 1 kHz .. 10 kHz
add 5 % error if 150 A < I_p < 200 A
- Influence of crest factor:**
< 3 % of output signal for crest factor < 5 with current < 280 A peak (50 A_{RMS})

MECHANICAL SPECIFICATIONS

- Operating temperature:**
-10 °C to +55 °C
- Storage temperature:**
-40 °C to +70 °C
- Influence of temperature:**
≤ 0.20 % of output signal per 10 °K
- Relative humidity for operation:**
0 to 85 % RH decreasing linearly above 35 °C
- Influence of relative humidity:**
< 0.2 % of output signal from 10 % to 85 % RH
- Operating altitude:**
0 to 2,000 m
- Max. jaw opening:**
20 mm
- Clamping capacity:**
Cable: Ø max 20 mm
Busbar: 1 busbar of 20 x 5 mm
- Casing protection rating:**
IP40 (IEC 529)
- Drop test:**
1 m (IEC 68-2-32)
- Shock resistance:**
100 g (IEC 68-2-27)
- Vibration resistance:**
10/55/10 Hz, 0.15 mm (IEC 68-2-6)
- Self-extinguishing capability:**
Casing: UL94 V2
Jaws: UL94 V0

- Dimensions:**
135 x 51 x 30 mm
- Weight:**
180 g
- Colours:**
Dark grey case with red jaws
- Output:**
1.5 m two-wire lead with double or reinforced insulation terminated by 2 elbowed male safety plugs (4 mm)

SAFETY SPECIFICATIONS

- Electrical safety:**
Instrument with double insulation or reinforced insulation between the primary, the secondary and the grippable part located under the guard as per IEC 1010-1 & IEC 1010-2-032
- 600 V category III, pollution degree 2
- 300 V category IV, pollution degree 2
- Electromagnetic compatibility (EMC):**
EN 50081-1: class B
EN 50082-2:
- Electrostatic discharge: IEC 1000-4-2
- Radiated field: IEC 1000-4-3
- Fast transients: IEC 1000-4-4
- Magnetic field at 50 Hz: IEC 1000-4-8

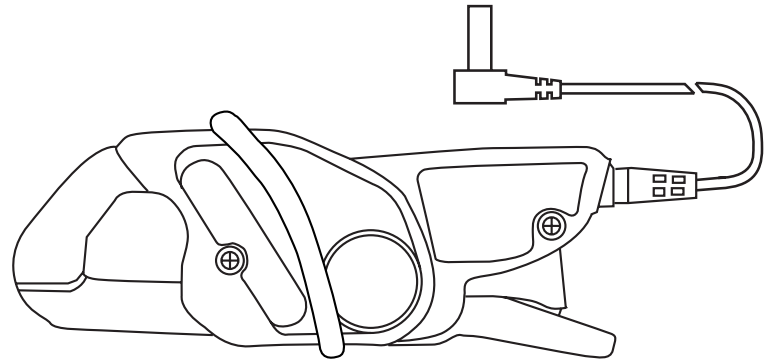

(1) Conditions of reference: 23 °C ± 3 °K, 20 to 70 % RH, sinusoidal signal with frequency of 48 Hz to 65 Hz, external magnetic field < 40 A/m, no DC components, no external conductor with circulating current, conductor centred for measurement, 1 Ω load.

(2) Out of reference domain

To order	Reference
AC current clamp model MN21 with operating manual	P01120418

Current clamp for AC current

Model MN23

MN series

Current	200 A AC
Output	10 mV/A

ELECTRICAL SPECIFICATIONS

- **Current range:**
0.1 A AC .. 240 A AC
- **Output signal:**
10 mVAC/A AC (2.4 V for 240 A)
- **Accuracy and phase shift (1):**

Primary current	0.1 A .. 1 A	1 A .. 20 A	20 A .. 80 A	80 A .. 150 A	150 A .. 200 A
% Accuracy of output signal	≤ 3 % + 200 μA	≤ 2 % + 200 μA	≤ 1 %	≤ 4 %	≤ 10 %
Phase shift	not specified	≤ 3°	≤ 2°	≤ 2.5°	≤ 3.5°

- **Bandwidth:**
40 Hz .. 10 kHz
- **Crest factor:**
5 for a current of 280 A peak
- **Maximum currents:**
200 A continuous for a frequency ≤ 1 kHz (limitation proportional to the inverse of frequency beyond)
- **Load impedance:**
> 1 MΩ
- **Operating voltage:**
600 V_{RMS}
- **Common mode voltage:**
600 V category III and pollution degree 2
- **Influence of adjacent conductor:**
≤ 15 mA/A at 50 Hz
- **Influence of conductor position in jaws:**
≤ 0.5 % of output signal at 50/60 Hz
- **Influence of frequency at IP < 100 A (2):**
< 5 % of output signal from 40 Hz .. 1 kHz**
< 15 % of output signal from 1 kHz .. 10 kHz
**Add 10 % error if 100 < IP < 200 A
- **Influence of crest factor:**
< 3 % of output signal for a crest factor
< 5 to a current < 280 A peak (50 A_{RMS})

MECHANICAL SPECIFICATIONS

- **Operating temperature:**
-10 °C to +55 °C
- **Storage temperature:**
-40 °C to +70 °C
- **Influence of temperature:**
≤ 0.20 % of output signal per 10 °K
- **Relative humidity for operation:**
0 to 85 % RH decreasing linearly above 35 °C
- **Influence of relative humidity:**
< 0.2 % of output signal from 10 % to 85 % RH
- **Operating altitude:**
0 to 2,000 m
- **Max. jaw opening:**
20 mm
- **Clamping capacity:**
Cable: Ø max 20 mm
Busbar: 1 busbar of 20 x 5 mm
- **Casing protection rating:**
IP40 (IEC 529)
- **Drop test:**
1 m (IEC 68-2-32)
- **Shock resistance:**
100 g (IEC 68-2-27)
- **Vibration resistance:**
10/55/10 Hz, 0.15 mm (IEC 68-2-6)

- **Self-extinguishing capability:**
Casing: UL94 V2
Jaws: UL94 V0
- **Dimensions:**
135 x 51 x 30 mm
- **Weight:**
180 g
- **Colours:**
Dark grey case with red jaws
- **Output:**
1.5 m two-wire lead with double or reinforced insulation terminated by 2 elbowed male safety plugs (4 mm)

SAFETY SPECIFICATIONS

- **Electrical safety:**
Instrument with double insulation or reinforced insulation between the primary, the secondary and the grippable part located under the guard as per IEC 1010-1 & IEC 1010-2-032
- 606.5 V category III, pollution degree 2
- 306.5 V category IV, pollution degree 2
- **Electromagnetic compatibility (EMC):**
EN 50081-1: class B
EN 50082-2:
- Electrostatic discharge: IEC 1000-4-2
- Radiated field: IEC 1000-4-3
- Fast transients: IEC 1000-4-4
- Magnetic field at 50 Hz: IEC 1000-4-8

(1) Conditions of reference: 23 °C ± 3 °K, 20 to 70 % RH, sinusoidal signal with frequency of 48 Hz to 65 Hz, external magnetic field < 40 A/m, no DC components, no external conductor with circulating current, conductor centred for measurement, load impedance > 1 MΩ.

(2) Out of reference domain.

To order	Reference
AC current clamp model MN23 with operating manual	P01120419

Current clamps for AC current

Models MN38 and MN39

MN series

Current	20 A AC	200 A AC
Output	100 mV/A	10 mV/A

ELECTRICAL SPECIFICATIONS

- **Current range:**
0.1 A AC .. 24 A AC
0.5 A AC .. 240 A AC
- **Output signal:**
100 mV AC / A AC (2.4 V for 24 A)
10 mV AC / A AC (2.4 V for 240 A)
- **Accuracy and phase shift ⁽¹⁾:**

Calibre	20 A		200 A		
	0.1 A .. 20 A	0.5 A .. 10 A	10 A .. 40 A	40 A .. 100 A	100 A .. 240 A
Primary current	0.1 A .. 20 A	0.5 A .. 10 A	10 A .. 40 A	40 A .. 100 A	100 A .. 240 A
% Accuracy of output signal	≤ 1% + 50 mV	≤ 3% + 5 mV	≤ 2.5% + 5 mV	≤ 2% + 5 mV	≤ 1% + 5 mV
Phase shift	not specified	not specified	≤ 5°	≤ 3°	≤ 2.5°

- **Bandwidth:**
40 Hz .. 10 kHz
- **Crest factor:**
3 for a current of 200 A_{RMS}
- **Maximum currents:**
200 A continuous for a frequency ≤ 1 kHz (limitation proportional to the inverse of frequency beyond)
- **Load impedance:**
> 1 MΩ
- **Operating voltage:**
600 V_{RMS}
- **Common mode voltage:**
600 V category III and pollution degree 2
- **Influence of adjacent conductor:**
≤ 15 mA/A at 50 Hz
- **Influence of conductor position in jaws:**
≤ 0.5 % of output signal at 50/60 Hz
- **Influence of frequency ⁽²⁾:**
 - 20 A calibre:
< 5 % of output signal from 40 Hz .. 1 kHz
< 15 % of output signal from 1 kHz .. 10 kHz
 - 200 A calibre:
< 3 % of output signal from 40 Hz .. 1 kHz
< 12 % of output signal from 1 kHz .. 10 kHz
- **Influence of crest factor:**
< 3 % of output signal for a crest factor of 3 and current of 200 A_{RMS}

MECHANICAL SPECIFICATIONS

- **Operating temperature:**
-10 °C to +55 °C
- **Storage temperature:**
-40 °C to +70 °C
- **Influence of temperature:**
≤ 0.15 % of output signal per 10 °K
- **Relative humidity for operation:**
0 to 85 % RH decreasing linearly above 35 °C
- **Influence of relative humidity:**
< 0.2 % of output signal from 10 % to 85 % RH
- **Operating altitude:**
0 to 2,000 m
- **Max. jaw opening:**
20 mm
- **Clamping capacity:**
Cable: Ø max 20 mm
Busbar: 1 busbar of 20 mm x 5 mm
- **Casing protection rating:**
IP40 (IEC 529)
- **Drop test:**
1 m (IEC 68-2-32)
- **Shock resistance:**
100 g (IEC 68-2-27)
- **Vibration resistance:**
10/55/10 Hz, 0.15 mm (IEC 68-2-6)
- **Self-extinguishing capability:**
Casing: UL94 V2
Jaws: UL94 V0

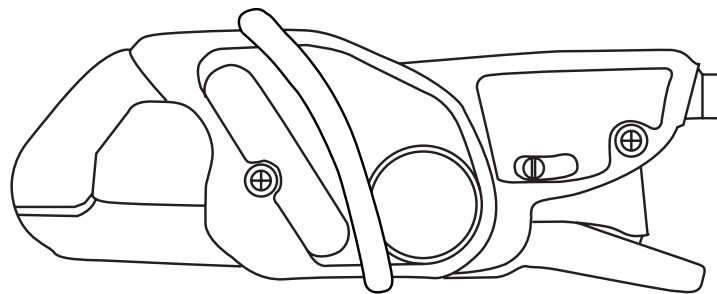

- **Dimensions:**
135 x 51 x 30 mm
- **Weight:**
180 g
- **Colours:**
Dark grey case with red jaws
- **Output:**
MN38:
Safety jacks (4 mm)
MN39:
1.5 m two-wire lead with double or reinforced insulation terminated by 2 elbowed male safety plugs (4 mm)

SAFETY SPECIFICATIONS

- **Electrical safety:**
Instrument with double insulation or reinforced insulation between the primary the secondary and the grippable part located under the guard as per IEC 1010-1 & IEC 1010-2-032
- 600 V category III, pollution degree 2
- 300 V category IV, pollution degree 2
- **Electromagnetic compatibility (EMC):**
EN 50081-1: class B
EN 50082-2:
- Electrostatic discharge: IEC 1000-4-2
- Radiated field: IEC 1000-4-3
- Fast transients: IEC 1000-4-4
- Magnetic field at 50/60 Hz: IEC 1000-4-8

(1) Conditions of reference: 23 °C ± 3 °K, 20 to 70 % RH, sinusoidal signal with frequency of 48 Hz to 65 Hz, external magnetic field < 40 A/m, no DC components, no external conductor with circulating current, conductor centred for measurement, load impedance > 1 MΩ.

(2) Out of reference domain

To order	Reference
AC current clamp model MN38 with operating manual	P01120407
AC current clamp model MN39 with operating manual	P01120408

Model MN60 (insulated AC current probe)

Current	60 A peak	600 A peak
Output	100 mV/A	10 mV/A

DESCRIPTION

This 200 A AC clamp enables easy display and measurement of "current" curves. It fits any oscilloscope since it has a coaxial lead with BNC plug. It produces a mV signal directly proportional to current. It offers 2 different sensitivities.

ELECTRICAL SPECIFICATIONS

- Current range:**
0.1 A AC .. 20 A AC (60 A peak)
0.5 A AC .. 200 A AC (600 A peak)
- Output signal:**
100 mV AC / A AC (2 V for 20 A)
10 mV AC / A AC (2 V for 200 A)

- Accuracy and phase shift ⁽¹⁾:**

Calibre	20 A		200 A		
	0.1 A .. 20 A	0.5 A .. 10 A	10 A .. 40 A	40 A .. 100 A	100 A .. 240 A
Primary current					
% Accuracy of output signal	≤ 2% + 50 mV	≤ 3.5% + 5 mV	≤ 3% + 5 mV	≤ 2.5% + 5 mV	≤ 1.5% + 5 mV
Phase shift	not specified	not specified	≤ 6°	≤ 4°	≤ 3°

- Bandwidth:**
40 Hz .. 40 kHz (-3 dB) (depending on current value)
- Rise/fall time from 10 % to 90 %:**
 - 20 A calibre: 7.4 μs
 - 200 A calibre: 8.7 μs
- 10 % delay time:**
0.1 μs
- Ampere second product:**
 - 20 A calibre: 25 A.s
 - 200 A calibre: 2 A.s
- Insertion impedance (at 400 Hz / 10 kHz)**
 - 20 A calibre: < 0.3 mΩ / < 7.2 mΩ
 - 200 A calibre: < 1 mΩ / < 26 mΩ
- Maximum currents:**
200 A continuous for a frequency ≤ 3 kHz (limitation proportional to inverse of one third of frequency beyond)
- Influence of temperature:**
≤ 150 ppm / k or 0.15 % of output signal per 10 °K
- Influence of relative humidity:**
< 0.2 % of output signal
- Influence of adjacent conductor:**
≤ 15 mA/A at 50 Hz
- Influence of DC current < 10 % of rated calibre superimposed on the rated current:**
 - 20 A calibre:
For I DC < 2 A: influence < 0.5 %
 - 200 A calibre:
For I DC < 20 A: influence < 5 %
- Influence of conductor position in jaws:**
≤ 0.5 % of output signal at 50/60 Hz

- Influence of frequency ⁽²⁾:**
 - 20 A calibre:
< 10 % of output signal from 40 Hz .. 1 kHz
< 15 % of output signal from 1 kHz .. 10 kHz
 - 200 A calibre:
< 3 % of output signal from 40 Hz .. 1 kHz
< 12 % of output signal from 1 kHz .. 10 kHz
- Influence of crest factor:**
< 3 % of output signal for a crest factor of 3 and current of 200 A_{RMS}

MECHANICAL SPECIFICATIONS

- Operating temperature:**
-10 °C to +55 °C
- Storage temperature:**
-40 °C to +70 °C
- Relative humidity for operation:**
0 to 85 % RH decreasing linearly above 35 °C
- Operating altitude:**
0 to 2,000 m
- Max. jaw opening:**
20 mm
- Clamping capacity:**
Cable: Ø max 20 mm
Busbar: 1 busbar of 20 x 5 mm
- Casing protection rating:**
IP40 (IEC 529)
- Drop test:**
1 m (IEC 68-2-32)
- Shock resistance:**
100 g / 6 ms / half-periode (IEC 68-2-27)

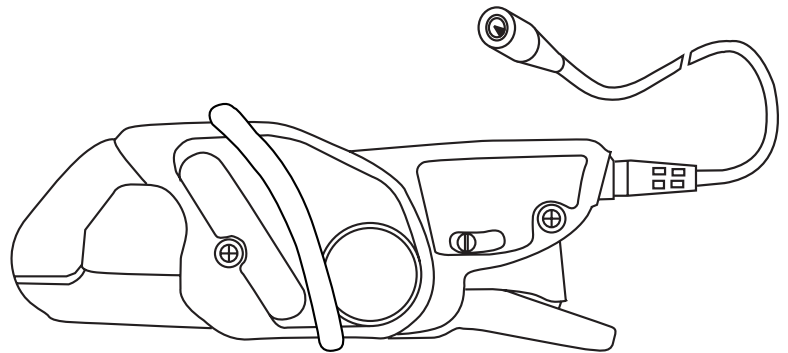

- Protection against impacts:**
IK04 0.5 J (EN 50102)
- Vibration resistance:**
10/55/10 Hz, 0.15 mm (IEC 68-2-6)
- Self-extinguishing capability:**
Casing: UL94 V2
Jaws: UL94 V0
- Dimensions:**
128 x 49 x 28 mm
- Weight:**
180 g
- Colours:**
Dark grey case with red jaws
- Output:**
Coaxial cable 2 m long, terminated by an insulated BNC connector

SAFETY SPECIFICATIONS

- Electrical safety:**
Instrument with double insulation or reinforced insulation between the primary, the secondary and the grippable part located under the guard as per IEC 1010-1 & IEC 1010-2-032
- 600 V category III, pollution degree 2
- 300 V category IV, pollution degree 2
- Electromagnetic compatibility (EMC):**
EN 50081-1: class B
EN 50082-2:
- Electrostatic discharge: IEC 1000-4-2
4 kV level 2 performance criterion B
8 kV in the air level 3 performance criterion B
- Radiated field: IEC 1000-4-3
10 V/m performance criterion A
- Fast transients: IEC 1000-4-4
1 kV level 2 performance criterion B
2 kV level 3 performance criterion B
- Magnetic field at 50/60 Hz: IEC 1000-4-8
field of 400 A/m at 50 Hz: < 1 A

CURVES AT 50 Hz

200 A calibre

20 A calibre

Error on measurement

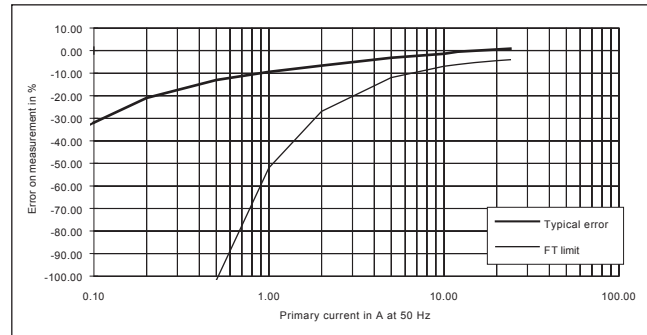
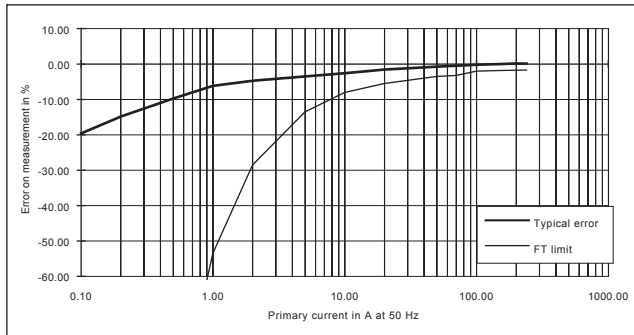

Phase shift

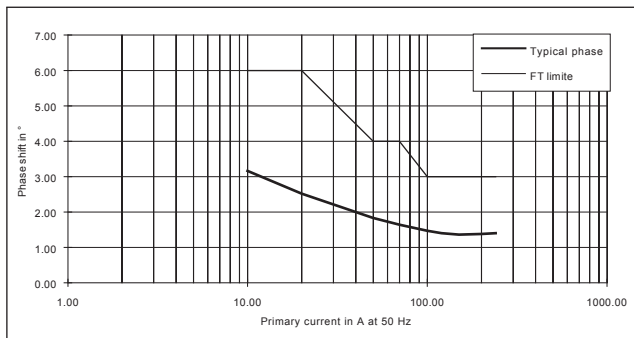

FREQUENCY RESPONSE

200 A calibre

20 A calibre

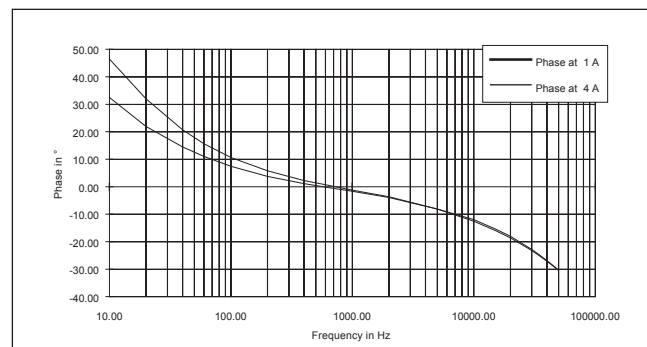
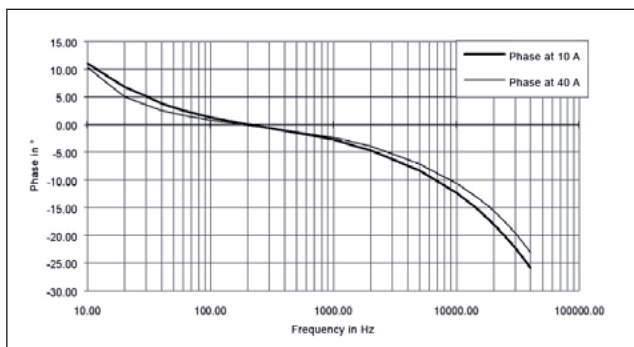
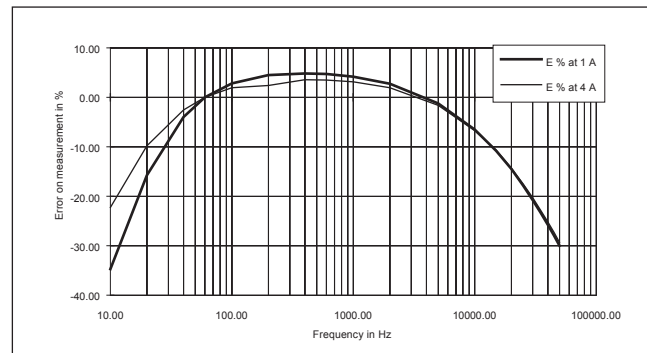
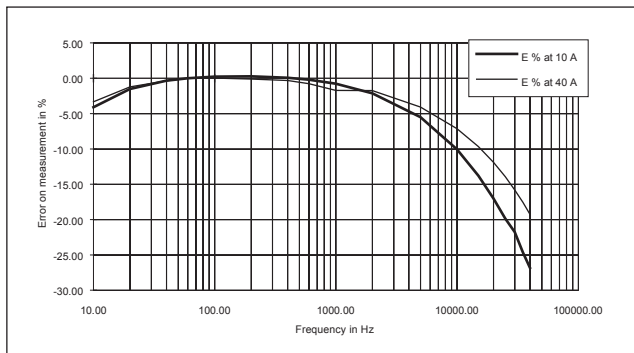

FREQUENCY RESPONSE (CONT.)

200 A calibre

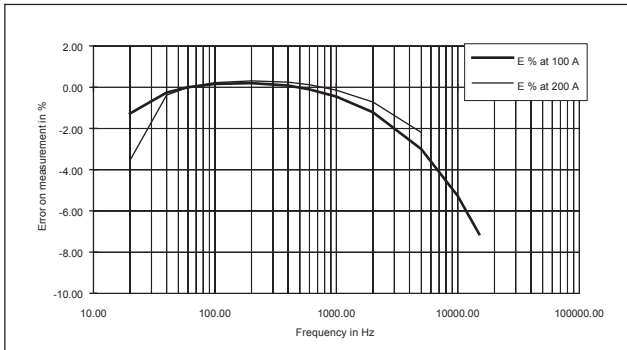

20 A calibre

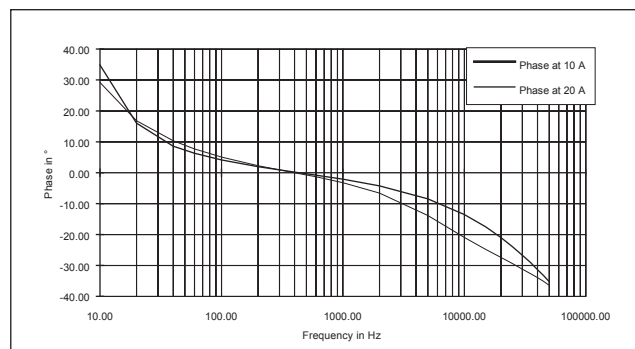
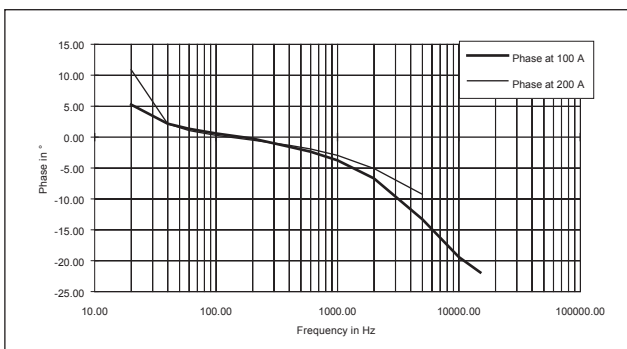
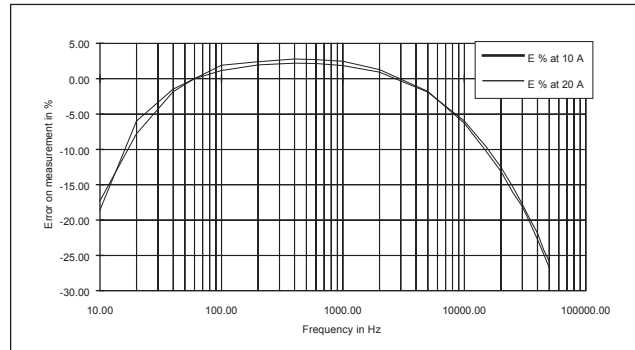

RESPONSE TO A SQUARE SIGNAL

200 A calibre

20 A calibre

10 A at 10 Hz

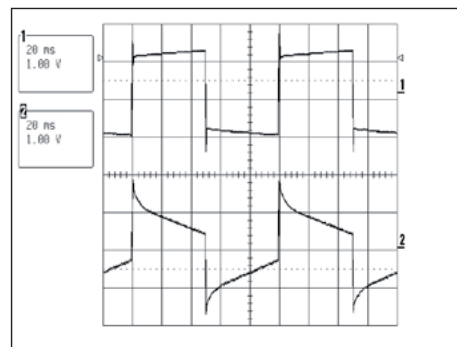
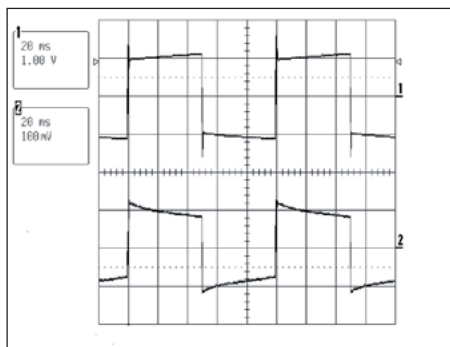

10 A at 100 Hz

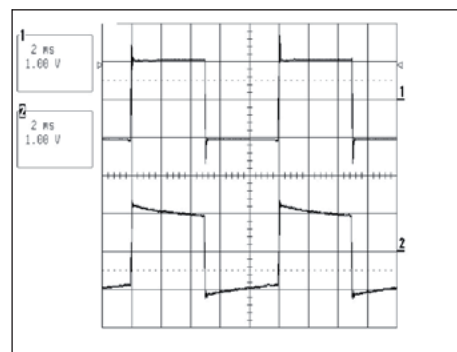
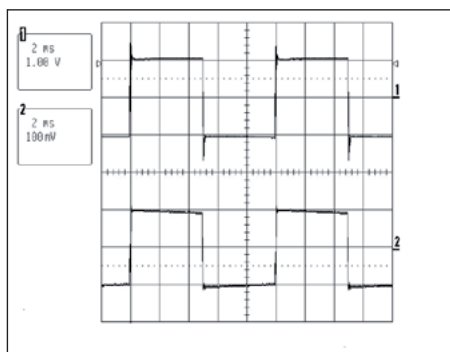

RESPONSE TO A SQUARE SIGNAL (CONT.)

200 A calibre

20 A calibre

10 A at 1 kHz

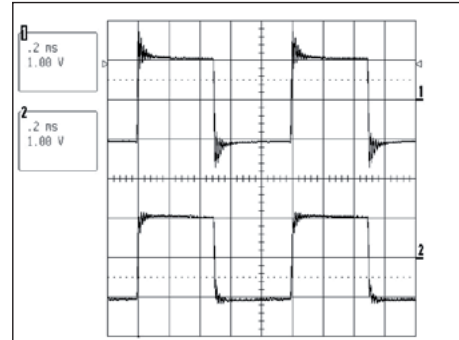
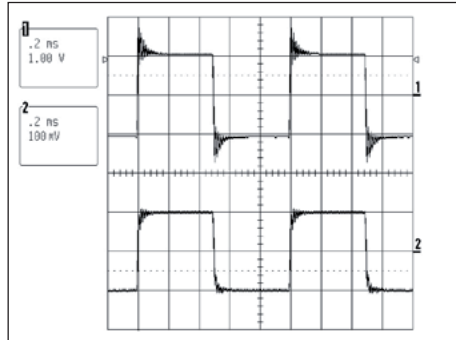

10 A at 10 kHz

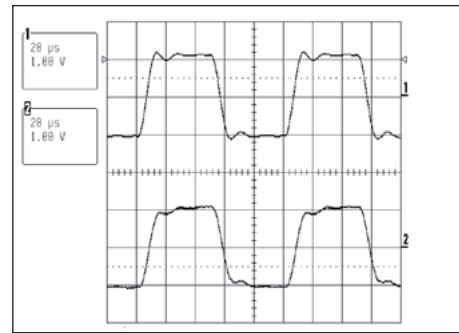
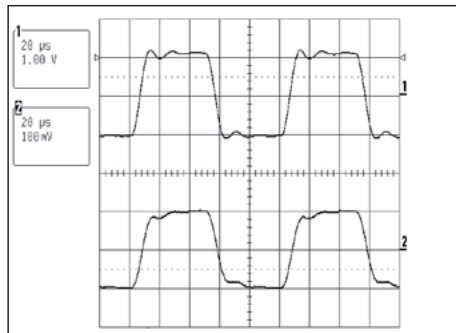

- (1) Conditions of reference: 23 °C ± 3 °K, 20 % to 75 % RH, sinusoidal signal with frequency of 48 Hz at 1 kHz, external magnetic field < 40 A/m, no DC components, no external conductor with circulating current, conductor centred for measurement, load impedance > 1 MΩ and < 100 pF.
 (2) Out of reference domain

To order	Reference
AC current clamp model MN60 for oscilloscope with operating manual	P01120409

Model MN71

Current	10 A AC
Output	100 mV/A

DESCRIPTION

This clamp was specially designed to measure current on current transformer secondary circuits.

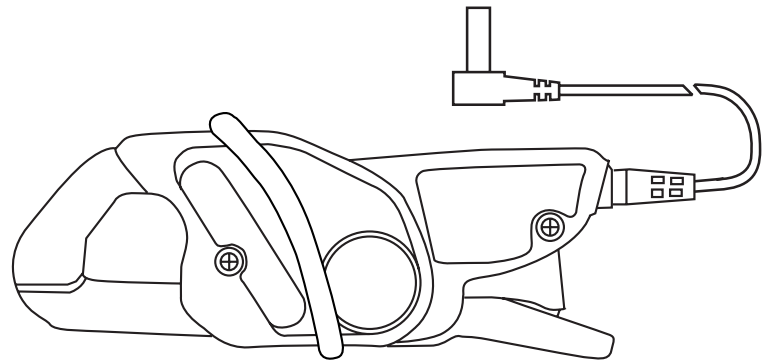

ELECTRICAL SPECIFICATIONS

- **Current range:**
0.01 A AC .. 12 A AC
- **Output signal:**
100 mVAC/A AC (1.2 V for 12 A)
- **Accuracy and phase shift ⁽¹⁾:**

Primary current	0.01 A .. 0.1 A	0.1 A .. 1 A	1 A .. 5 A	5 A .. 12 A
Accuracy in % of output signal	≤ 3 % + 0.1 mV	≤ 2.5 %	≤ 1 %	
Phase shift	not specified	≤ 5°	≤ 3°	≤ 3°

- **Bandwidth:**
40 Hz .. 10 kHz
- **Crest factor:**
5 for a current of 40 A peak (8 A_{RMS})
- **Maximum currents:**
20 A continuous for a frequency ≤ 10 kHz (limitation proportional to the inverse of one tenth of frequency beyond)
- **Load impedance:**
> 1 MΩ
- **Operating voltage:**
600 V_{RMS}
- **Common mode voltage:**
600 V category III and pollution degree 2
- **Influence of adjacent conductor:**
< 15 mA/A at 50 Hz
- **Influence of conductor position in jaws:**
< 0.5 % of output signal at 50/60 Hz
- **Influence of frequency ⁽²⁾:**
< 5 % of output signal from 20 Hz .. 1 kHz
< 10 % of output signal from 1 kHz .. 10 kHz
- **Influence of crest factor:**
< 3 % of output signal for crest factor < 5 with current < 40 A_{RMS}

MECHANICAL SPECIFICATIONS

- **Operating temperature:**
-10 °C to +55 °C
- **Storage temperature:**
-40 °C to +70 °C
- **Influence of temperature:**
≤ 0.2 % of output signal per 10 °K
- **Relative humidity for operation:**
0 to 85 % RH decreasing linearly above 35 °C
- **Influence of relative humidity:**
< 0.2 % of output signal from 10 % to 85 % RH
- **Operating altitude:**
0 to 2,000 m
- **Max. jaw opening:**
20 mm
- **Clamping capacity:**
Cable: Ø max 20 mm
Busbar: 1 busbar of 20 x 5 mm
- **Casing protection rating:**
IP40 (IEC 529)
- **Drop test:**
1 m (IEC 68-2-32)
- **Shock resistance:**
100 g (IEC 68-2-27)
- **Vibration resistance:**
10/55/10 Hz, 0.15 mm (IEC 68-2-6)

- **Self-extinguishing capability:**
Casing: UL94 V2
Jaws: UL94 V0
- **Dimensions:**
135 x 51 x 30 mm
- **Weight:**
180 g
- **Colours:**
Dark grey case with red jaws
- **Output:**
1.5 m two-wire lead with double or reinforced insulation terminated by 2 elbowed male safety plugs (4 mm)

SAFETY SPECIFICATIONS:

- **Electrical safety:**
Instrument with double insulation or reinforced insulation between the primary the secondary and the grippable part located under the guard as per IEC 1010-1 & IEC 1010-2-032
- 600 V category III, pollution degree 2
- 300 V category IV, pollution degree 2
- **Electromagnetic compatibility (EMC):**
EN 50081-1: class B
EN 50082-2:
- Electrostatic discharge: IEC 1000-4-2
- Radiated field: IEC 1000-4-3
- Fast transients: IEC 1000-4-4
- Magnetic field at 50 Hz: IEC 1000-4-8

(1) Conditions of reference: 23 °C ± 3 °K, 20 % to 75 % RH, sinusoidal signal with frequency of 48 Hz to 65 Hz, external magnetic field < 40 A/m, no DC components, no external conductor with circulating current, conductor centred for measurement, load impedance > 1 MΩ.

(2) Out of reference domain

To order	Reference
AC current clamp model MN71 with operating manual	P01120420

Model MN73

Current	2 A AC	200 A AC
Output	1,000 mV/A	10 mV/A

DESCRIPTION

This clamp has a wide measurement range (up to 200 A), and it can also measure very low currents. We call it the "universal" probe.

ELECTRICAL SPECIFICATIONS

- **Current calibres:**
0.01 A AC .. 2.4 A AC
0.1 A AC .. 240 A AC
- **Output signal:**
1,000 mV AC / A AC (2 V for 2 A)
10 mV AC / A AC (2.4 V for 240 A)
- **Accuracy and phase shift ⁽¹⁾:**

Calibre	2 A				200 A				
	0.01 A .. 0.1 A	0.1 A .. 1 A	1 A .. 2 A	2 A .. 2.4 A	0.1 A .. 1 A	1 A .. 20 A	20 A .. 80 A	80 A .. 150 A	150 A .. 200 A
Primary current									
% Accuracy of output signal	≤ 5 % + 2 mV	≤ 3 % + 1 mV	≤ 1 %	≤ 1 %	≤ 3 % + 200 μV	≤ 2 % + 200 μV	≤ 1 %	≤ 4 %	≤ 10 %
Phase shift	not specified				not specified	≤ 3°	≤ 2°	≤ 3°	≤ 4°

- **Bandwidth:**
40 Hz .. 10 kHz
- **Crest factor:**
5 for a current of 280 A peak (200 A_{RMS})
- **Maximum currents:**
200 A continuous for a frequency ≤ 1 kHz (limitation proportional to the inverse frequency beyond)
- **Load impedance:**
> 1 MΩ
- **Operating voltage:**
600 V_{RMS}
- **Common mode voltage:**
600 V category III and pollution degree 2
- **Influence of adjacent conductor:**
≤ 15 mA/A at 50 Hz
- **Influence of conductor position in jaws:**
≤ 0.5 % of output signal at 50/60 Hz
- **Influence of frequency ⁽²⁾:**
 - Calibre 2 A:
< 10 % of output signal from 40 Hz .. 10 kHz
 - 200 A calibre:
< 5 % of output signal from 40 Hz .. 1 kHz**
< 15 % of output signal from 1 kHz .. 10 kHz
** add 10 % error if 100 A < I_{primary} < 200 A
- **Influence of crest factor:**
< 5 % of output signal for crest factor < 5 with current < 280 A_{RMS}

MECHANICAL SPECIFICATIONS

- **Operating temperature:**
-10 °C to +55 °C
- **Storage temperature:**
-40 °C to +70 °C
- **Influence of temperature:**
≤ 0.20 % of output signal per 10 °K
- **Relative humidity for operation:**
0 to 85 % RH decreasing linearly above 35 °C
- **Influence of relative humidity:**
< 0.2 % of output signal from 10 % to 85 % RH
- **Operating altitude:**
0 to 2,000 m
- **Max. jaw opening:**
20 mm
- **Clamping capacity:**
Cable: Ø max 20 mm
Busbar: 1 busbar of 20 x 5 mm
- **Casing protection rating:**
IP40 (IEC 529)
- **Drop test:**
1 m (IEC 68-2-32)
- **Shock resistance:**
100 g (IEC 68-2-27)
- **Vibration resistance:**
10/55/10 Hz, 0.15 mm (IEC 68-2-6)

- **Self-extinguishing capability:**
Casing: UL94 V2
Jaws: UL94 V0
- **Dimensions:**
135 x 51 x 30 mm
- **Weight:**
180 g
- **Colours:**
Dark grey case with red jaws
- **Output:**
1.5 m two-wire lead with double or reinforced insulation terminated by 2 elbowed male safety plugs (4 mm)

SAFETY SPECIFICATIONS

- **Electrical safety:**
Instrument with double insulation or reinforced insulation between the primary the secondary and the grippable part located under the guard as per IEC 1010-1 & IEC 1010-2-032
- 600 V category III, pollution degree 2
- 300 V category IV, pollution degree 2
- **Electromagnetic compatibility (EMC):**
EN 50081-1: class B
EN 50082-2:
- Electrostatic discharge: IEC 1000-4-2
- Radiated field: IEC 1000-4-3
- Fast transients: IEC 1000-4-4
- Magnetic field at 50 Hz: IEC 1000-4-8

(1) Conditions of reference: 23 °C ± 3 °K, 20 % to 75 % RH, sinusoidal signal with frequency of 48 Hz to 65 Hz, external magnetic field < 40 A/m, no DC components, no external conductor with circulating current, conductor centred for measurement, load impedance > 1 MΩ.

(2) Out of reference domain

To order	Reference
AC current clamp model MN73 with operating manual	P01120421
Accessory: AN1 artificial neutral box (see chapter 12)	P01197201

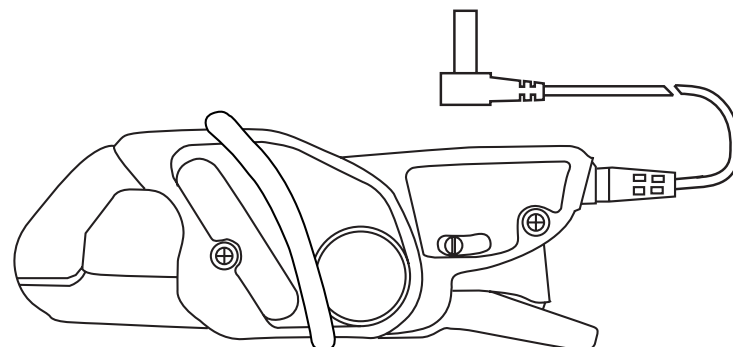

Models MN88 and MN89

Current	200 A AC
Output	100 mV DC/A

DESCRIPTION

These clamps produce a DC voltage output which is very useful for multimeters whose sensitivity in V or A is too weak.

ELECTRICAL SPECIFICATIONS

- **Current range:**
0.5 A AC .. 240 A AC
- **Output signal:**
100 mV DC/A (24 V for 240 A AC)
- **Accuracy ⁽¹⁾:**

Primary current	0.5 A .. 10 A	10 A .. 40 A	40 A .. 100 A	100 A .. 240 A
% Accuracy of output signal	≤ 5 % + 50 mV	≤ 3 % + 50 mV	≤ 2 % + 50 mV	≤ 2 %

- **Bandwidth:**
40 Hz .. 10 kHz
- **Crest factor:**
3 for a current of 200 A_{RMS}
- **Maximum currents:**
200 A continuous for a frequency ≤ 1 kHz (derating proportional to the inverse of frequency beyond)
- **Load impedance:**
> (1 MΩ + filter RC 2s)
- **Operating voltage:**
600 V_{RMS}
- **Common mode voltage:**
600 V category III and pollution degree 2
- **Influence of adjacent conductor:**
≤ 15 mA / A at 50 Hz
- **Influence of conductor position in jaws:**
≤ 0.5 % of output signal at 50 Hz
- **Influence of frequency ⁽²⁾:**
< 5 % of output signal from 40 Hz .. 1 kHz < 12 % of output signal from 1 kHz .. 10 kHz
- **Influence of crest factor**
< 3 % of output signal for a crest factor of 3 and current of 200 A_{RMS}

MECHANICAL SPECIFICATIONS

- **Operating temperature:**
-10 °C to +55 °C
- **Storage temperature:**
-40 °C to +70 °C
- **Influence of temperature:**
≤ 0.15 % of output signal per 10 °K
- **Relative humidity for operation:**
0 to 85 % RH decreasing linearly above 35 °C
- **Influence of relative humidity:**
< 0.2 % of output signal from 10 % to 85 % RH
- **Operating altitude:**
0 to 2,000 m
- **Max. jaw opening:**
20 mm
- **Clamping capacity:**
Cable: Ø max 20 mm
Busbar: 1 busbar of 20 x 5 mm
- **Casing protection rating:**
IP40 (IEC 529)
- **Drop test:**
1 m (IEC 68-2-32)
- **Shock resistance:**
100 g (IEC 68-2-27)
- **Vibration resistance:**
10/55/10 Hz, 0.15 mm (IEC 68-2-6)
- **Self-extinguishing capability:**
Casing: UL94 V2
Jaws: UL94 V0

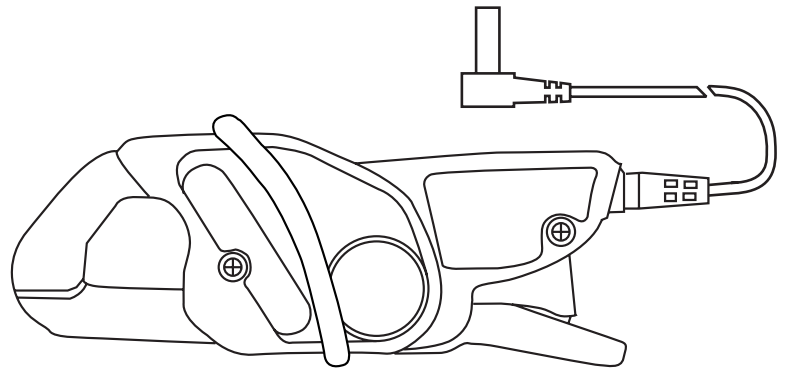

- **Dimensions:**
135 x 51 x 30 mm
- **Weight:**
180 g
- **Colours:**
Dark grey case with red jaws
- **Output:**
MN88:
Safety jacks (4 mm)
MN89:
1.5 m two-wire lead with double or reinforced insulation terminated by 2 elbowed male safety plugs (4 mm)

SAFETY SPECIFICATIONS

- **Electrical safety:**
Instrument with double insulation or reinforced insulation between the primary the secondary and the grippable part located under the guard as per IEC 1010-1 & IEC 1010-2-032
- 600 V category III, pollution degree 2
- 300 V category IV, pollution degree 2
- **Electromagnetic compatibility (EMC):**
EN 50081-1: class B
EN 50082-2:
- Electrostatic discharge: IEC 1000-4-2
- Radiated field: IEC 1000-4-3
- Fast transients: IEC 1000-4-4
- Magnetic field at 50/60 Hz: IEC 1000-4-8

(1) Conditions of reference: 23 °C ± 3 °K, 20 to 70 % RH, sinusoidal signal with frequency of 48 Hz to 65 Hz, external magnetic field < 40 A/m, no DC components, no external conductor with circulating current, conductor centred for measurement, load impedance > 1 MΩ + filter RC 2s.

(2) Out of reference domain

To order	Reference
AC current clamp model MN88 with operating manual	P01120410
AC current clamp model MN89 with operating manual	P01120415

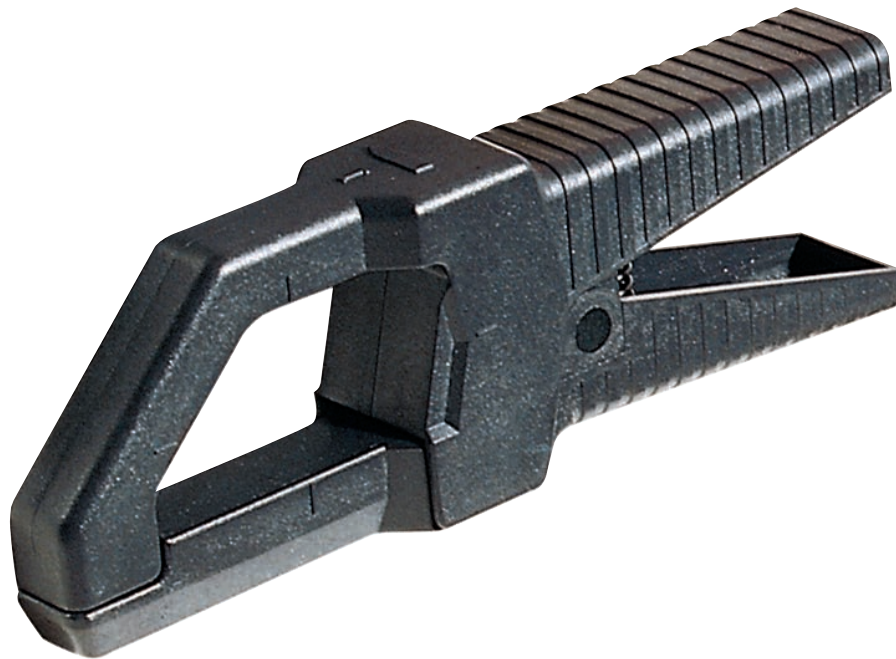

Y_N SERIES

The Y series clamps are designed to be both rugged and versatile whilst remaining easy to use. The jaws are designed so that the clamps can be hooked onto cables or clamped onto busbars for current measurement up to 600 A AC.

There are two types of Y series clamps available:

The first acts as a current transformer (ratios of 100:1 or 1000:1), giving an output current that may be read by a multimeter, logger or other suitable devices with appropriate current calibres.

The other kind of Y series clamp has a DC voltage output proportional to the AC current measured, allowing instruments without current calibres to measure, display and record currents on a DC voltage calibre.

There is also a model available specifically for direct use with oscilloscopes.

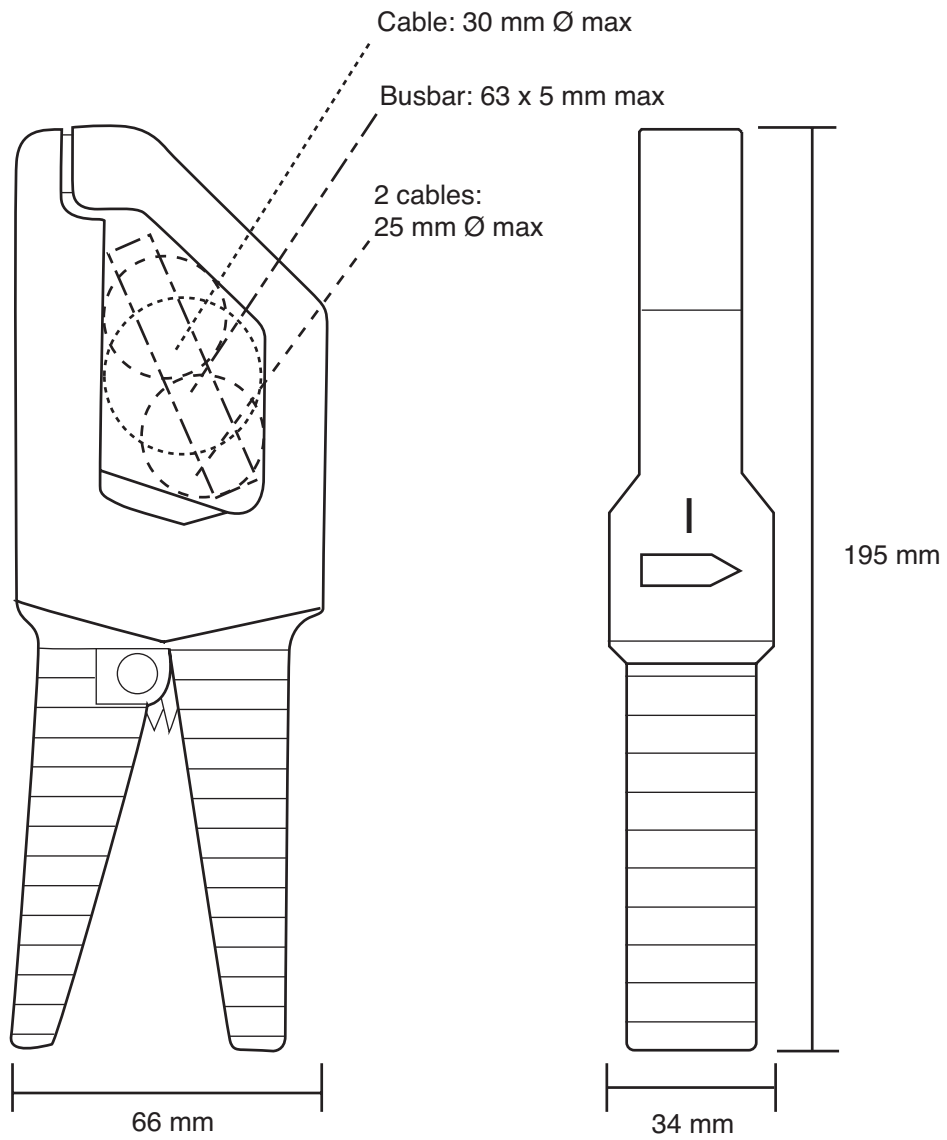

Model Y1N

Current	500 A AC
Ratio	1000/1
Output	1 mA/A

ELECTRICAL SPECIFICATIONS

- **Current range:**
4 A AC .. 600 A AC
- **Current transformation ratio:**
1000:1
- **Output signal:**
1 mA AC/A AC
- **Accuracy ⁽¹⁾:**

Primary current	4 A	25 A	100 A	250 A	500 A	600 A ⁽²⁾
Accuracy in % of output signal	4.5 % + 0.5 mA	4.5 %	3.5 %	3 %	3 %	3 %
Phase shift	not specified	4°	2°	2°	2°	2°

class 3 at 1.25 VA

- **Bandwidth:**
48 Hz .. 1,000 Hz
- **Load impedance:**
5 Ω max
- **Overload:**
700 A for 10 minutes
- **Maximum output voltage (secondary open):**
Electronic protection circuit limiting voltage to 10 V peak max
- **Operating voltage:**
600 V_{RMS}
- **Common mode voltage:**
600 V_{RMS}
- **Influence of adjacent and parallel conductors:**
< 30 mA/A at 50 Hz
- **Influence of conductor position in jaws:**
±1.5 %

MECHANICAL SPECIFICATIONS

- **Operating temperature:**
-15 °C .. +50 °C
- **Storage temperature:**
-40 °C .. +85 °C
- **Influence of temperature:**
< 0.1 % per 10 °K
- **Operating altitude:**
0 to 2,000 m
- **Max. jaw opening:**
33 mm
- **Clamping capacity:**
Cable: Ø max 30 mm
Busbar: 63 x 5 mm
- **Casing protection rating:**
IP20 in accordance with IEC 529
- **Drop test:**
1.5 m (IEC 68-2-32)
- **Shock resistance:**
100 g, in accordance with IEC 68-2-27
- **Vibration resistance:**
10/55/10 Hz, 0.15 mm test in accordance with IEC 68-2-6
- **Self-extinguishing capability:**
UL94 V0

- **Dimensions:**
66 x 195 x 34 mm
- **Weight:**
420 g
- **Colour:**
Dark grey
- **Output:**
1.5 m two-wire lead with double or reinforced insulation terminated by 2 elbowed male safety plugs (4 mm)

SAFETY SPECIFICATIONS

- **Electrical safety:**
Double or reinforced insulation between the primary and secondary circuits and the outer casing in accordance with IEC 1010-2-032.
- 600 V category III, pollution degree 2
- 300 V category IV, pollution degree 2
- **Electromagnetic compatibility (EMC):**
EN 50081-1: class B
EN 50082-2:
- Electrical discharge: IEC 1000-4-2
- Radiated field: IEC 1000-4-3
- Fast transients: IEC 1000-4-4
- Magnetic field at 50/60 Hz: IEC 1000-4-8

(1) Conditions of reference: 23 °C ± 5 °K, 20 % to 75 % RH, 48 Hz to 65 Hz, external magnetic field < 40 A/m, no current-carrying conductor nearby, centred test sample, load impedance 5 Ω.

(2) 700 A for 10 minutes max.

To order	Reference
AC current clamp model Y1N with operating manual	P01120001A

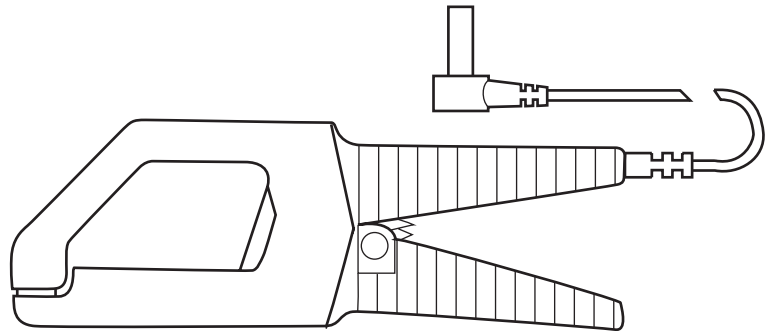

Model Y2N

Current	500 A AC
Ratio	1000/1
Output	1 mA/A

ELECTRICAL SPECIFICATIONS

- **Current range:**
4 A AC .. 600 A AC
- **Current transformation ratio:**
1000:1
- **Output signal:**
1 mA AC/A AC
- **Accuracy ⁽¹⁾:**

Primary current	4 A	25 A	100 A	250 A	500 A	600 A ⁽²⁾
Accuracy in % of output signal	3% + 0.5 mA	3%	1.5%	1%	1%	1%
Phase shift	not specified	3°	1.5°	1°	1°	1°

class 1 at 1.25 VA

- **Bandwidth:**
48 Hz .. 1,000 Hz
- **Load impedance:**
5 Ω max
- **Overload:**
700 A for 10 minutes
- **Maximum output voltage (secondary open):**
Electronic protection circuit limiting voltage to 10 V peak max
- **Operating voltage:**
600 V_{RMS}
- **Common mode voltage:**
600 V_{RMS}
- **Influence of adjacent and parallel conductors:**
< 30 mA/A at 50 Hz
- **Influence of conductor position in jaws:**
< 1%

MECHANICAL SPECIFICATIONS

- **Operating temperature:**
-15 °C .. +50 °C
- **Storage temperature:**
-40 °C .. +85 °C
- **Influence of temperature:**
< 0.1% per 10 °K
- **Operating altitude:**
0 to 2,000 m
- **Max. jaw opening:**
33 mm
- **Clamping capacity:**
Cable: Ø max 30 mm
Busbar: 63 x 5 mm
- **Casing protection rating:**
IP20 in accordance with IEC 529
- **Drop test:**
1.5 m (IEC 68-2-32)
- **Shock resistance:**
100 g, in accordance with IEC 68-2-27
- **Vibration resistance:**
10/55/10 Hz, 0.15 mm test in accordance with IEC 68-2-6
- **Self-extinguishing capability:**
UL94 V0

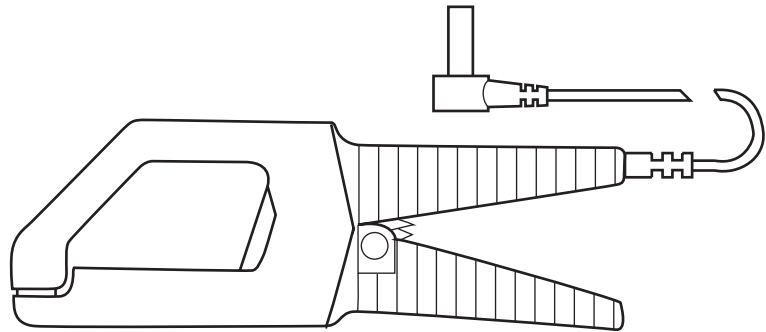

- **Dimensions:**
66 x 195 x 34 mm
- **Weight:**
420 g
- **Colour:**
Dark grey
- **Output:**
1.5 m two-wire lead with double or reinforced insulation terminated by 2 elbowed male safety plugs (4 mm)

SAFETY SPECIFICATIONS

- **Electrical safety:**
Double or reinforced insulation between the primary and secondary circuits and the outer casing in accordance with IEC 1010-2-032.
- 600 V category III, pollution degree 2
- 300 V category IV, pollution degree 2
- **Electromagnetic compatibility (EMC):**
EN 50081-1: class B
EN 50082-2:
- Electrical discharge: IEC 1000-4-2
- Radiated field: IEC 1000-4-3
- Fast transients: IEC 1000-4-4
- Magnetic field at 50/60 Hz: IEC 1000-4-8

(1) Conditions of reference: 23 °C ± 5 °K, 20% to 75% RH, 48 Hz to 65 Hz, external magnetic field < 40 A/m, no current-carrying conductor nearby, centred test sample, load impedance 5 Ω.

(2) 700 A for 10 minutes max

To order	Reference
AC current clamp model Y2N with operating manual	P01120028A

Model Y3N

Current	500 A AC
Ratio	100/1
Output	10 mA/A

ELECTRICAL SPECIFICATIONS

- **Current range:**
4 A AC .. 600 A AC
- **Current transformation ratio:**
100:1
- **Output signal:**
10 mA AC/A AC
- **Accuracy ⁽¹⁾:**

Primary current	4 A	25 A	100 A	250 A	500 A	600 A ⁽²⁾
Accuracy in % of output signal	5% + 5 mA	5%	3%	3%	3%	3%
Phase shift	not specified	6°	5°	3°	3°	3°

class 3 at 2.5 VA

- **Bandwidth:**
48 Hz .. 1,000 Hz
- **Load impedance:**
0.1 Ω max
- **Overload:**
700 A for 10 minutes
- **Maximum output voltage (secondary open):**
Electronic protection circuit limiting voltage to 10 V peak max
- **Operating voltage:**
600 V_{RMS}
- **Common mode voltage:**
30 V_{RMS}
- **Influence of adjacent and parallel conductors:**
< 30 mA/A at 50 Hz
- **Influence of conductor position in jaws:**
±1 %

MECHANICAL SPECIFICATIONS

- **Operating temperature:**
15 °C .. +50 °C
- **Storage temperature:**
-40 °C .. +85 °C
- **Influence of temperature:**
< 0.1 % per 10 °K
- **Operating altitude:**
0 to 2,000 m
- **Max. jaw opening:**
33 mm
- **Clamping capacity:**
Cable: Ø max 30 mm
Busbar: 63 x 5 mm
- **Casing protection rating:**
IP20 in accordance with IEC 529
- **Drop test:**
1.5 m (IEC 68-2-32)
- **Shock resistance:**
100 g, in accordance with IEC 68-2-27
- **Vibration resistance:**
10/55/10 Hz, 0.15 mm test in accordance with IEC 68-2-6
- **Self-extinguishing capability:**
UL94 V0

- **Dimensions:**
66 x 195 x 34 mm
- **Weight:**
420 g
- **Colour:**
Dark grey
- **Output:**
1.5 m two-wire lead with double or reinforced insulation terminated by 2 elbowed male safety plugs (4 mm)

SAFETY SPECIFICATIONS

- **Electrical safety:**
Double or reinforced insulation between the primary and secondary circuits and the outer casing in accordance with IEC 1010-2-032.
- 600 V category III, pollution degree 2
- 300 V category IV, pollution degree 2
- **Electromagnetic compatibility (EMC):**
EN 50081-1: class B
EN 50082-2:
- Electrical discharge: IEC 1000-4-2
- Radiated field: IEC 1000-4-3
- Fast transients: IEC 1000-4-4
- Magnetic field at 50/60 Hz: IEC 1000-4-8

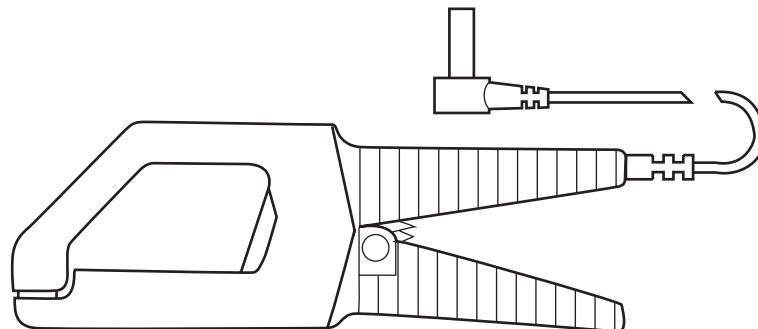

(1) Conditions of reference: 23 °C ± 5 °K, 20 % to 75 % RH, 48 Hz to 65 Hz, external magnetic field < 40 A/m, no current-carrying conductor nearby, centred test sample, load impedance 0.1 Ω.

(2) 700 A for 10 minutes max.

To order	Reference
AC current clamp model Y3N with operating manual	P01120029A

Model Y4N

Current	500 A AC
Output	1 mV DC/A AC

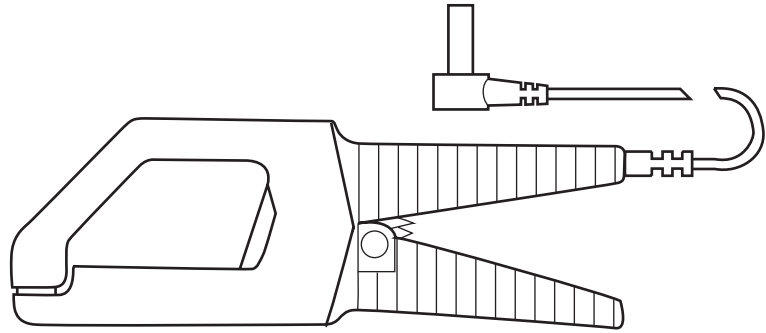

ELECTRICAL SPECIFICATIONS

- **Current range:**
4 A AC .. 600 A AC
- **Output signal:**
1 mV DC/A AC
- **Accuracy ⁽¹⁾:**

Primary current	2 A	25 A	100 A	250 A	500 A	600 A ⁽²⁾
Accuracy in % of output signal	5 % + 0.5 mV DC	5 %	2 %	1 %	1 %	2 %

- **Bandwidth:**
48 Hz .. 1,000 Hz
(error: add 2 % to reference)
- **Load impedance:**
> 100 kΩ max
- **Overload:**
700 A for 10 minutes
- **Operating voltage:**
600 V_{RMS}
- **Common mode voltage:**
600 V_{RMS}
- **Influence of adjacent and parallel conductors:**
< 30 mA/A at 50 Hz
- **Influence of conductor position in jaws:**
±1 %

MECHANICAL SPECIFICATIONS

- **Operating temperature:**
15 °C .. +50 °C
- **Storage temperature:**
-40 °C .. +85 °C
- **Influence of temperature:**
< 0.1 % per 10 °K

- **Operating altitude:**
0 to 2,000 m
- **Max. jaw opening:**
33 mm
- **Clamping capacity:**
Cable: Ø max 30 mm
Busbar: 63 x 5 mm
- **Casing protection rating:**
IP20 in accordance with IEC 529
- **Drop test:**
1.5 m (IEC 68-2-32)
- **Shock resistance:**
100 g, in accordance with IEC 68-2-27
- **Vibration resistance:**
10/55/10 Hz, 0.15 mm test in accordance with IEC 68-2-6
- **Self-extinguishing capability:**
UL94 V0
- **Dimensions:**
66 x 195 x 34 mm
- **Weight:**
420 g
- **Colour:**
Dark grey

- **Output:**
1.5 m two-wire lead with double or reinforced insulation terminated by 2 elbowed male safety plugs (4 mm)

SAFETY SPECIFICATIONS

- **Electrical safety:**
Double or reinforced insulation between the primary and secondary circuits and the outer casing in accordance with IEC 1010-2-032.
- 600 V category III, pollution degree 2
- 300 V category IV, pollution degree 2
- **Electromagnetic compatibility (EMC):**
EN 50081-1: class B
EN 50082-2:
- Electrical discharge: IEC 1000-4-2
- Radiated field: IEC 1000-4-3
- Fast transients: IEC 1000-4-4
- Magnetic field at 50/60 Hz: IEC 1000-4-8

(1) Conditions of reference: 23 °C ± 5 °K, 20 % to 75 % RH, 48 Hz to 65 Hz, external magnetic field < 40 A/m, no current-carrying conductor nearby, centred test sample, load impedance 10 MΩ.

(2) 600 A for 10 minutes max

To order	Reference
AC current clamp model Y4N with operating manual	P01120005A

Model Y7N (insulated AC current probe)

Current	1,200 A peak
Output	1 mV/A

DESCRIPTION

This 500 A AC clamp can be used for the display and measurement of 'current' curves. It comes with a coaxial cable terminated by a BNC plug, thus making it the ideal tool for use with oscilloscopes. It supplies a mV output signal that is directly proportional to the measured current.

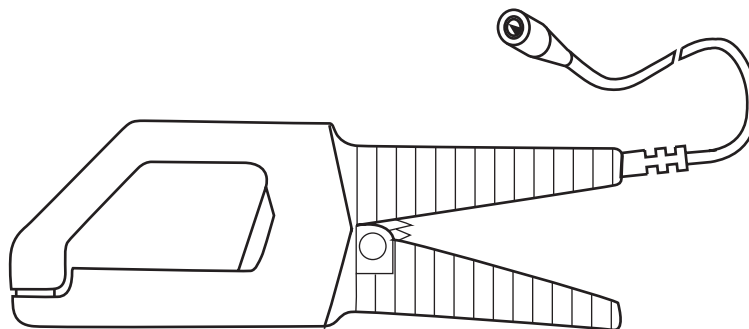

ELECTRICAL SPECIFICATIONS

- **Current range:**
1 A AC .. 500 A AC (1,200 A peak)
- **Output signal:**
1 mV AC/A AC (0.5 V for 500 A)

- **Accuracy and phase shift (°):**

Primary current	1 A .. 20 A	20 A .. 100 A	100 A .. 500 A
% Accuracy of output signal	≤ 5 % + 0.3 mV	≤ 5 %	≤ 2 %
Phase shift	not specified	≤ 3°	≤ 1°

- **Bandwidth:**
5 Hz .. 10 kHz (at -3 dB) (depending on current)
- **Rise/fall time from 10 % to 90%:**
37 μs
- **10 % delay time:**
1 μs
- **Ampere second product:**
10 A.s
- **Insertion impedance (at 400 Hz / 10 kHz):**
< 0.1 mΩ / < 3.1 mΩ
- **dV/dt:**
0.24 mV/μs (typical)
- **Maximum currents:**
500 A constant
700 A: 10 minutes operation / 30 minutes shutdown for frequency ≤ 2 kHz (limitation proportional to the inverse of one third of the frequency above that)
- **Internal load impedance:**
≤ 100 Ω / 4.7 nF
- **Influence of temperature:**
≤ 0.15 % of output signal per 10 °K
- **Influence of adjacent conductor:**
≤ 5 μV / A at 50 Hz
- **Influence of conductor position in jaws:**
≤ 1.5 % + 0.1 A AC

MECHANICAL SPECIFICATIONS

- **Operating temperature:**
-25 °C to +50 °C
- **Storage temperature:**
-40 °C to +80 °C
- **Relative humidity for operation:**
0 to 85 % RH decreasing linearly above 35 °C
- **Operating altitude:**
0 to 2,000 m
- **Max. jaw opening:**
33 mm
- **Clamping capacity:**
Cable: Ø max 30 mm
Busbar: 1 busbar of 63 x 5 mm
- **Casing protection rating:**
IP20 (IEC 529)
- **Drop test:**
1.5 m (IEC 68-2-32)
- **Shock resistance:**
100 g / 6 ms / half-period (IEC 68-2-27)
- **Protection against impacts:**
IK04 0.5 J (EN 50102)
- **Vibration resistance:**
10/55/10 Hz 0.15 mm (IEC 68-2-6)
- **Self-extinguishing capability:**
UL94 V0
- **Dimensions:**
195 x 66 x 34 mm

- **Weight:**
420 g
- **Colour:**
Dark grey
- **Output:**
Via 2 m coaxial cable terminated by insulated BNC plug

SAFETY SPECIFICATIONS

- **Electrical safety:**
Instrument with double insulation or reinforced insulation between the primary the secondary and the grippable part located under the guard as per IEC 1010-1 & IEC 1010-2-032
- 600 V category III, pollution degree 2
- 300 V category IV, pollution degree 2
- **Electromagnetic compatibility (EMC):**
EN 50081-1: class B
EN 50082-2:
- Electrostatic discharge: IEC 1000-4-2
4 kV level 2 performance criterion B
8 kV in the air level 3 performance criterion B
- Radiated field: IEC 1000-4-3
10 V/m performance criterion A
- Fast transients: IEC 1000-4-4
1 kV level 2 performance criterion B
2 kV level 3 performance criterion B
- Magnetic field at 50/60 Hz: IEC 1000-4-8
field of 400 A/m at 50 Hz: < 1 A

CURVES

Error on measurement at 50 Hz

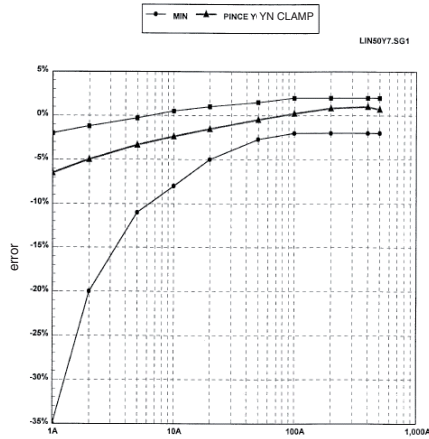

Phase shift at 50 Hz

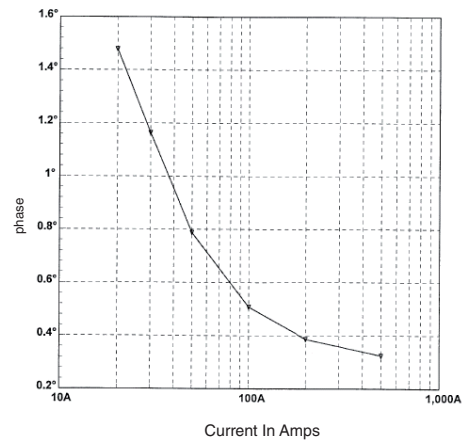

Frequency response

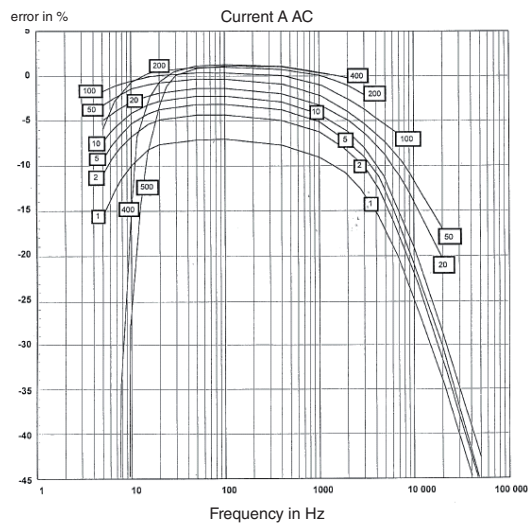

Phase shift according to frequency

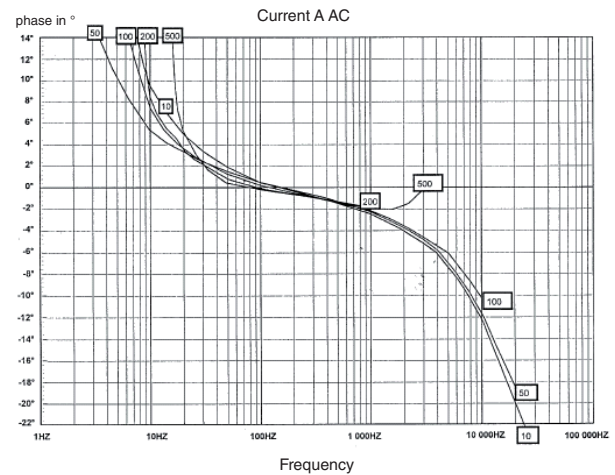

Influence of frequency and derating

Frequency Hz	5 Hz to 10 Hz	10 Hz to 20 Hz	20 Hz to 45 Hz	65 Hz to 3 kHz	3 kHz to 6 kHz	6 kHz to 10 kHz
1 A to 200 A	15 %					
> 200 A	not spec.					
1 A to 300 A		5 %				
300 A to 400 A		15 %				
400 A to 500 A		25 %				
1 A to 500 A			5 %			
1 A to 50 A				5 % + 0.4 A		
50 A to 500 A				5 %		
> 500 A				not spec.		
1 A to 100 A					15 % + 0.4 A	
> 100 A					not spec.	
1 A to 50 A						-3 dB
> 50 A						not spec.

- Error in % of reading; not spec. means not specified
 - Do not exceed 500 A for measurement with constant operation, and for the derating, use the formula $500(A) \cdot \sqrt{2/F(kHz)}$ to calculate the maximum current in A AC, in constant use, depending on the frequency in kHz.

Influence of DC current

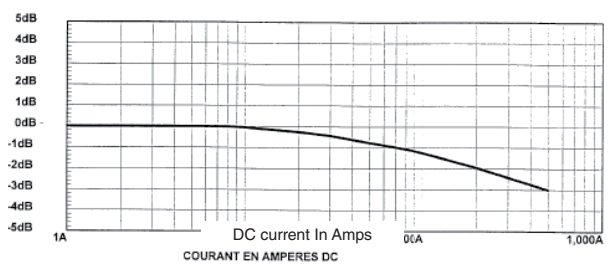

RESPONSE TO A SQUARE SIGNAL

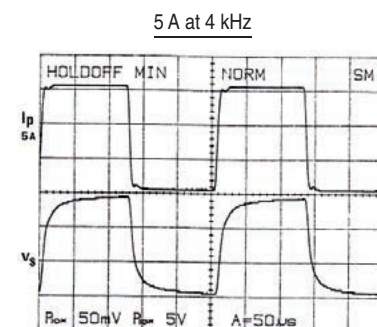
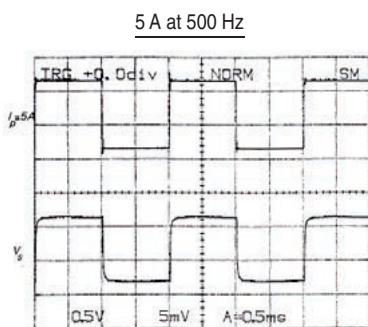
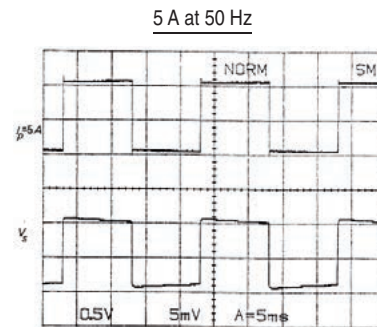
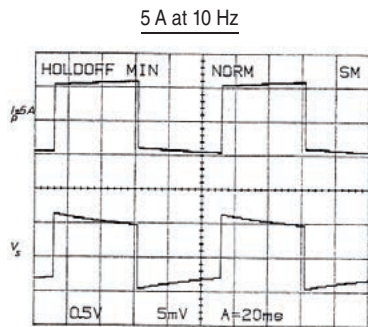

RESPONSE TO A STEP

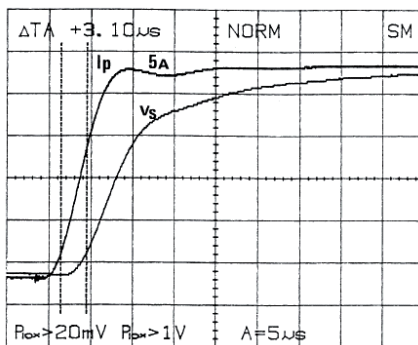

(1) Conditions of reference: 23°C ± 3°K, 20% to 75% RH, sinusoidal signal with frequency of 48 Hz at 1 kHz, external magnetic field < 40 A/m, no DC components, no external conductor with circulating current, conductor centred for measurement, load impedance > 1 MΩ / < 100 pF.

To order	Reference
AC current clamp model Y7N for oscilloscope with operating manual	P01120075



"C 100" SERIES

The "C100" series is a range of thirteen transformer clamps with all the advantages of our old "C30" series clamps whilst incorporating considerable improvements, particularly in the field of safety, ergonomics and performance:

- 1,000 A measurement, excellent metrology, high accuracy, high level of linearity, symmetrical coil windings for minimum phase shift, pendular adjusting system for magnetic elements, maximum conductor diameter \varnothing 52 mm and also some models with μ metal core specially made for wattmeter use.
- Innovative design: excellent ergonomics, handle with finger grips, assisted opening system for jaws (patented system), IEC 1010 600 V cat. III safety (industry and services), antislip protection, conductor anti-pinching system,...

All this technology and manufacturing quality has been combined to provide the best measurement possible without any complications.

A "C100" series clamp is compatible with any instrument (multimeter, wattmeter, recorder, oscilloscope...) for safe measurement of AC currents without shutting down the installation.

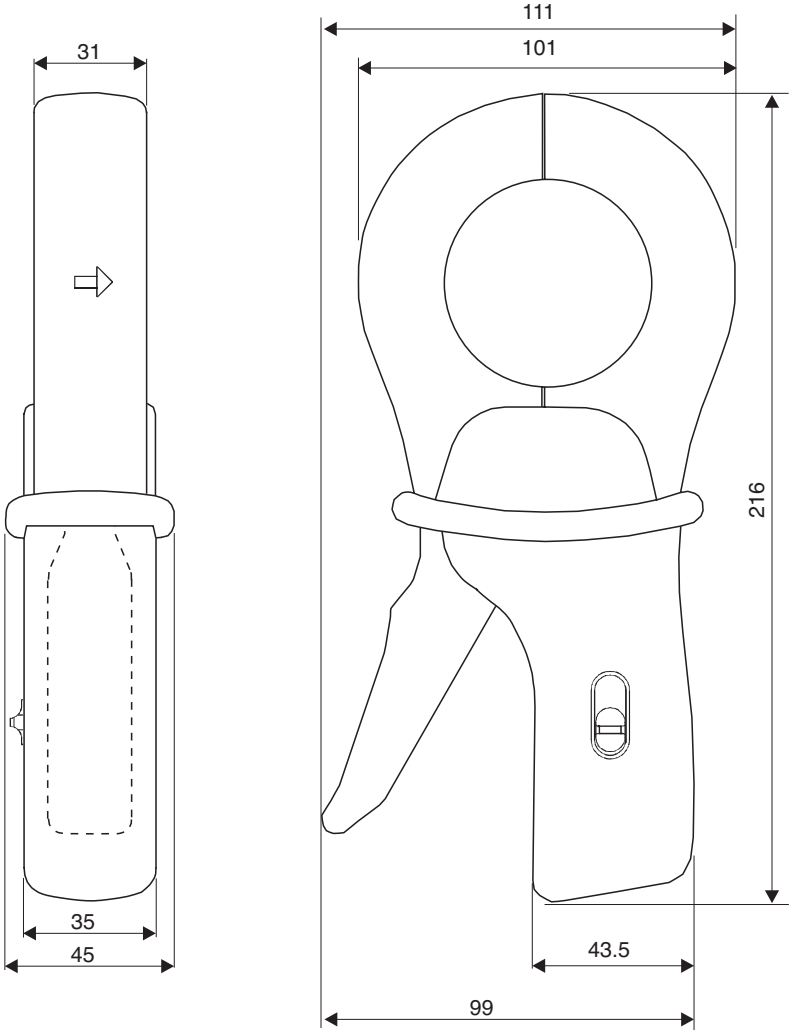

Current clamp for AC current

Model C100

C100 series

Current	1,000 A
Ratio	1000/1
Output	1 mA/A

ELECTRICAL SPECIFICATIONS

- **Current range:**
0.1 A AC .. 1,200 A AC
- **Current transformation ratio:**
1000:1
- **Output signal:**
1 mA AC/A AC (1 A to 1,000 A)
- **Accuracy and phase shift ⁽¹⁾:**

Primary current	0.1 A .. 10 A	10 A	50 A ⁽²⁾	200 A ⁽²⁾	1,000 A ⁽²⁾	1,200 A ⁽²⁾
% Accuracy of output signal	≤ 3% + 0.1 mA	≤ 3%	≤ 1.5%	≤ 0.75%	≤ 0.5%	≤ 0.5%
Phase shift	not specified	≤ 3°	≤ 1.5°	≤ 0.75°	≤ 0.5°	≤ 0.5°

- **Bandwidth:**
30 Hz .. 10 kHz (-3 dB)
- **Crest factor:**
≤ 6 for a current ≤ 3,000 A peak (500 A_{RMS})
- **Maximum currents:**
1,000 A continuous for a frequency ≤ 1 kHz (limitation proportional to the inverse of frequency beyond)
1,200 A for 40 minutes max (interval between measurements > 20 minutes)
- **Load impedance:**
≤ 15 Ω
- **Operating voltage:**
600 V_{RMS}
- **Common mode voltage:**
600 V category III and pollution degree 2
- **Influence of adjacent conductor:**
≤ 1 mA/A at 50 Hz
- **Influence of conductor position in jaws:**
≤ 0.1 % of output signal for frequencies ≤ 400 Hz
- **Load influence:**
From 5 Ω to 15 Ω
< 0.5 % on measurement
< 0.5° on phase
- **Influence of frequency ⁽³⁾:**
< 1 % of output signal from 30 Hz .. 48 Hz
< 0.5 % of output signal from 65 Hz .. 1 kHz
< 1 % of output signal from 1 kHz .. 5 kHz
- **Influence of crest factor:**
< 1 % of output signal for crest factor ≤ 6 with current ≤ 3,000 A peak (500 A_{RMS})

- **Influence of DC current superimposed on rated current:**
< 1 % of output signal for a current ≤ 30 A DC

MECHANICAL SPECIFICATIONS

- **Operating temperature:**
-10 °C to +50 °C
- **Storage temperature:**
-40 °C to +70 °C
- **Influence of temperature:**
≤ 0.1 % of output signal per 10°K
- **Relative humidity for operation:**
0 to 85 % RH decreasing linearly above 35 °C
- **Influence of relative humidity:**
< 0.1 % of output signal from 10 % to 85 % RH
- **Operating altitude:**
0 to 2,000 m
- **Max. jaw opening:**
53 mm
Patented progressive opening system
- **Clamping capacity:**
Cable: Ø max 52 mm
Busbar: 1 busbar of 50 x 5 mm / 4 busbars of 30 x 5 mm
- **Casing protection rating:**
IP40 (IEC 529)
- **Drop test:**
1 m (IEC 68-2-32)
- **Shock resistance:**
100 g (IEC 68-2-27)

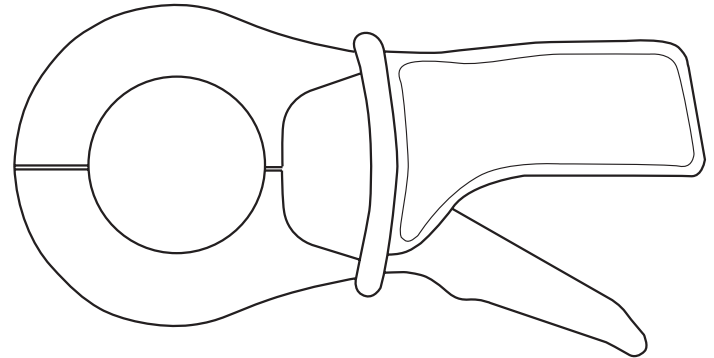

- **Vibration resistance:**
5/15 Hz 1.5 mm
15/25 Hz 1 mm
25/55 Hz 0.25 mm
(IEC 68-2-6)
- **Self-extinguishing capability:**
Casing and jaws: UL94 V0
- **Dimensions:**
216 x 111 x 45 mm
- **Weight:**
550 g
- **Colours:**
Dark grey case with red jaws
- **Output:**
Safety sockets (4 mm)

SAFETY SPECIFICATIONS

- **Electrical safety:**
Instrument with double insulation or reinforced insulation between the primary the secondary and the grippable part located under the guard as per IEC 1010-1 & IEC 1010-2-032
- 600 V category III, pollution degree 2
- 300 V category IV, pollution degree 2
- **Electromagnetic compatibility (EMC):**
EN 50081-1: class B
EN 50082-2:
- Electrostatic discharge: IEC 1000-4-2
- Radiated field: IEC 1000-4-3
- Fast transients: IEC 1000-4-4
- Magnetic field at 50/60 Hz: IEC 1000-4-8

(1) Conditions of reference: 23 °C ± 3°K, 20 % to 75 % RH, signal sinus, frequency of 48 Hz to 65 Hz, distortion factor < 1 %, no DC components, external magnetic field < 40 A/m, no AC magnetic field, conductor centred for measurement, load impedance 5 Ω (5 VA)

(2) Accuracy class in accordance with IEC 185: 5 VA - class 0.5 - 48 Hz .. 65 Hz

(3) Out of frequency domain

To order	Reference
AC current clamp model C100 with operating manual	P01120301

Current clamps for AC current

Models C102 and C103

C100 series

Current	1,000 A
Ratio	1000/1
Output	1 mA/A

DESCRIPTION

An electronic voltage limiter protects the output of the clamp, if the secondary circuit is opened accidentally.

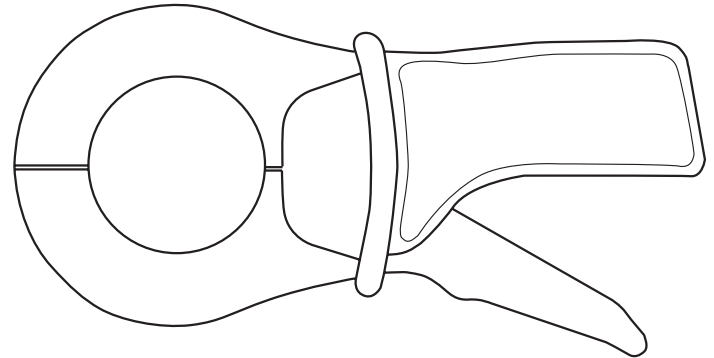

ELECTRICAL SPECIFICATIONS

- **Current range:**
0.1 A AC .. 1,200 A AC
- **Current transformation ratio:**
1000:1
- **Output signal:**
1 mA AC / A AC (1 A to 1,000 A)
- **Accuracy and phase shift ⁽¹⁾:**

Primary current	0.1 A .. 10 A	10 A	50 A ⁽²⁾	200 A ⁽²⁾	1,000 A ⁽²⁾	1,200 A ⁽²⁾
% Accuracy of output signal	≤ 3% + 0.1 mA	≤ 3%	≤ 1.5%	≤ 0.75%	≤ 0.5%	≤ 0.5%
Phase shift	not specified	≤ 3°	≤ 1.5°	≤ 0.75°	≤ 0.5°	≤ 0.5°

- **Bandwidth:**
30 Hz .. 10 kHz (-3 dB)
- **Crest factor:**
≤ 6 for a current ≤ 3,000 A peak (500 A_{RMS})
- **Maximum currents:**
1,000 A continuous for a frequency ≤ 1 kHz (limitation proportional to the inverse of frequency beyond)
1,200 A for 40 minutes max (interval between measurements > 20 minutes)
- **Load impedance:**
≤ 15 Ω
- **Max. voltage output:**
Electronic protection circuit limiting voltage to 30 V peak max
- **Operating voltage:**
600 V_{RMS}
- **Common mode voltage:**
600 V category III and pollution degree 2
- **Influence of adjacent conductor:**
≤ 1 mA/A at 50 Hz
- **Influence of conductor position in jaws:**
≤ 0.1 % of output signal for frequencies ≤ 400 Hz
- **Load influence:** from 5 Ω to 15 Ω
< 0.5 % on measurement
< 0.5° on phase
- **Influence of frequency ⁽³⁾:**
< 1 % of output signal from 30 Hz .. 48 Hz
< 0.5 % of output signal from 65 Hz .. 1 kHz
< 1 % of output signal from 1 kHz .. 5 kHz

- **Influence of crest factor:**
< 1 % of output signal for crest factor ≤ 6 with current ≤ 3,000 A peak (500 A_{RMS})
- **Influence of DC current superimposed on rated current:**
< 1 % of output signal for a current ≤ 30 A DC

MECHANICAL SPECIFICATIONS

- **Operating temperature:**
-10 °C to +50 °C
- **Storage temperature:**
-40 °C to +70 °C
- **Influence of temperature:**
≤ 0.1 % of output signal per 10 °K
- **Relative humidity for operation:**
0 to 85 % RH with a linear decrease above 35 °C
- **Influence of relative humidity:**
< 0.1 % of output signal from 10 % to 85 % RH
- **Operating altitude:**
0 to 2,000 m
- **Max. jaw opening:**
53 mm, patented progressive opening system
- **Clamping capacity:**
Cable: Ø max 52 mm
Busbar: 1 busbar of 50 x 5 mm /
4 busbars of 30 x 5 mm
- **Casing protection rating:**
IP40 (IEC 529)
- **Drop test:**
1 m (IEC 68-2-32)

- **Shock resistance:**
100 g (IEC 68-2-27)
- **Vibration resistance:**
5/15 Hz 1.5 mm - 15/25 Hz 1 mm - 25/55 Hz 0.25 mm (IEC 68-2-6)
- **Self-extinguishing capability:**
Casing and jaws: UL94 V0
- **Dimensions:**
216 x 111 x 45 mm
- **Weight:**
550 g
- **Colours:**
Dark grey case with red jaws
- **Output:**
C102: Safety sockets (4 mm)
C103: two-wire cable with reinforced insulation or double insulation, length 1.5 m, terminated by 2 insulated elbowed male banana plugs (4 mm)

SAFETY SPECIFICATIONS

- **Electrical safety:**
Instrument with double insulation or reinforced insulation between the primary the secondary and the grippable part located under the guard as per IEC 1010-1 & IEC 1010-2-032
- 600 V category III, pollution degree 2
- 300 V category IV, pollution degree 2
- **Electromagnetic compatibility (EMC):**
EN 50081-1: class B
EN 50082-2:
- Electrostatic discharge: IEC 1000-4-2
- Radiated field: IEC 1000-4-3
- Fast transients: IEC 1000-4-4
- Magnetic field at 50/60 Hz: IEC 1000-4-8

(1) Conditions of reference: 23 °C ± 3 °K, 20 % to 75 % RH, signal sinus, frequency of 48 Hz to 65 Hz, distortion factor < 1 %, no DC components, external magnetic field < 40 A/m, no AC magnetic field, conductor centred for measurement, load impedance 5 Ω (5 VA).

(2) Accuracy class in accordance with IEC 185: 5 VA - class 0.5 - 48 .. 65 Hz.

(3) Out of reference domain.

To order	Reference
AC current clamp model C102 with operating manual	P01120302
AC current clamp model C103 with operating manual	P01120303

Current clamps for AC current

Models C106 and C107

C100 series

Current	1,000 A
Output	1 mV/A

ELECTRICAL SPECIFICATIONS

- **Current range:**
0.1 A AC .. 1,200 A AC
- **Output signal:**
1 mV AC/A AC (1 V for 1,000 A)
- **Accuracy and phase shift (1):**

Primary current	0.1 A .. 10 A	10 A	50 A	200 A	1,000 A	1,200 A
% Accuracy of output signal	≤ 3% + 0.1 mV	≤ 3%	≤ 1.5%	≤ 0.75%	≤ 0.5%	≤ 0.5%
Phase shift	not specified	≤ 3°	≤ 1.5°	≤ 0.75°	≤ 0.5°	≤ 0.5°

- **Bandwidth:**
30 Hz .. 10 kHz
- **Crest factor:**
≤ 6 for a current ≤ 3,000 A peak (500 A_{RMS})
- **Maximum currents:**
1,000 A continuous for a frequency ≤ 1 kHz (limitation proportional to the inverse frequency beyond)
1,200 A for 40 minutes max (interval between measurements > 20 minutes)
- **Output impedance:**
1 Ω ± 1%
- **Load impedance:**
≥ 1 MΩ and ≤ 100 pF
- **Operating voltage:**
600 V_{RMS}
- **Common mode voltage:**
600 V category III and pollution degree 2
- **Influence of adjacent conductor:**
≤ 1 μV/A at 50 Hz
- **Influence of conductor position in jaws:**
≤ 0.1% of output signal for frequencies ≤ 400 Hz
- **Load influence:**
On receiver, for an input impedance of 100 Ω:
≤ 1% on measurement, no measurement on phase
On receiver, for an input impedance of 1 kΩ:
≤ 0.1% on measurement, no measurement on phase
- **Influence of frequency (2):**
< 1% of output signal from 30 Hz .. 48 Hz
< 0.5% of output signal from 65 Hz .. 1 kHz
< 1% of output signal from 1 kHz .. 5 kHz

- **Influence of crest factor:**
< 1% of output signal for crest factor ≤ 6 with current ≤ 3,000 A peak (500 A_{RMS})
- **Influence of DC current superimposed on rated current:**
< 1% of output signal for a current ≤ 30 A DC

MECHANICAL SPECIFICATIONS

- **Operating temperature:**
-10 °C to +50 °C
- **Storage temperature:**
-40 °C to +70 °C
- **Influence of temperature:**
≤ 0.1% of output signal per 10 °K
- **Relative humidity for operation:**
0 to 85% RH decreasing linearly above 35 °C
- **Influence of relative humidity:**
< 0.1% of output signal from 10% to 85% RH
- **Operating altitude:**
0 to 2,000 m
- **Max. jaw opening:**
53 mm
Patented progressive opening system
- **Clamping capacity:**
Cable: Ø max 52 mm
Busbar: 1 busbar of 50 x 5 mm / 4 busbars of 30 x 5 mm
- **Casing protection rating:**
IP40 (IEC 529)
- **Drop test:**
1 m (IEC 68-2-32)
- **Shock resistance:**
100 g (IEC 68-2-27)

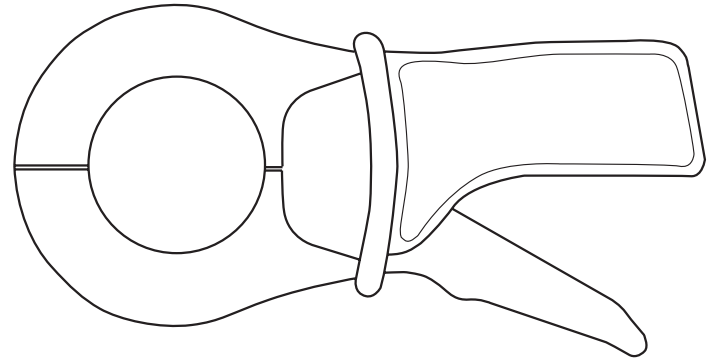

- **Vibration resistance:**
5/15 Hz 1.5 mm
15/25 Hz 1 mm
25/55 Hz 0.25 mm
(IEC 68-2-6)
- **Self-extinguishing capability:**
Casing and jaws: UL94 V0
- **Dimensions:**
216 x 111 x 45 mm
- **Weight:**
550 g
- **Colours:**
Dark grey case with red jaws
- **Output:**
C106: Safety sockets (4 mm)
C107: two-wire cable with reinforced insulation or double insulation, length 1.5 m, terminated by 2 insulated elbowed male banana plugs (4 mm)

SAFETY SPECIFICATIONS

- **Electrical safety:**
Instrument with double insulation or reinforced insulation between the primary the secondary and the grippable part located under the guard as per IEC 1010-1 & IEC 1010-2-032
- 600 V category III, pollution degree 2
- 300 V category IV, pollution degree 2
- **Electromagnetic compatibility (EMC):**
EN 50081-1: class B
EN 50082-2:
- Electrostatic discharge: IEC 1000-4-2
- Radiated field: IEC 1000-4-3
- Fast transients: IEC 1000-4-4
- Magnetic field at 50/60 Hz: IEC 1000-4-8

(1) Conditions of reference: 23 °C ± 3 °K, 20% to 75% RH, signal sinus, frequency of 48 Hz to 65 Hz, distortion factor < 1%, no DC components, external magnetic field < 40 A/m, no AC magnetic field, conductor centred for measurement.

(2) Out of reference domain.

To order	Reference
AC current clamp model C106 with operating manual	P01120304
AC current clamp model C107 with operating manual	P01120305

Current clamps for AC current

Models C112 and C113

C100 series

Current	1,000 A
Ratio	1000/1
Output	1 mA/A

DESCRIPTION

Thanks to their excellent technical performance (phase shift and linearity), these μ -metal core clamps are highly recommended for wattmeter use. These clamps are protected at output against overvoltages.

ELECTRICAL SPECIFICATIONS

- **Current range:**
0.001 A AC .. 1,200 A AC
- **Current transformation ratio:**
1000:1
- **Output signal:**
1 mA AC / A AC (1 A for 1,000 A)
- **Accuracy and phase shift⁽¹⁾:**

Primary current	0.1 A .. 100 mA	0.1 A .. 1 A	1 A .. 10 A	10 A .. 100 A	100 A .. 1,200 A
% Accuracy of output signal	$\leq 3\% + 5 \mu\text{A}$	$\leq 2\% + 3 \mu\text{A}$	$\leq 1\%$	$\leq 0.5\%$	$\leq 0.3\%$
Phase shift	not specified	not specified	$\leq 2^\circ$	$\leq 1^\circ$	$\leq 0.7^\circ$

- **Bandwidth:**
30 Hz .. 10 kHz
- **Crest factor:**
 ≤ 6 for a current $\leq 2,000$ A peak (300 A_{RMS})
- **Maximum currents:**
1,000 A continuous for a frequency ≤ 1 kHz (limitation proportional to the inverse of frequency beyond)
1,200 A for 40 minutes max (interval between measurements > 20 minutes)
- **Load impedance:**
 $\leq 1 \Omega$
- **Max. voltage output:**
Electronic protection circuit limiting voltage to 30 V peak max
- **Operating voltage:**
600 V_{RMS}
- **Common mode voltage:**
600 V category III and pollution degree 2
- **Influence of adjacent conductor:**
 ≤ 0.5 mA/A at 50 Hz
- **Influence of conductor position in jaws:**
 $\leq 0.1\%$ of output signal for frequencies ≤ 400 Hz
- **Load influence:**
From 1Ω to 5Ω
 $< 0.1\%$ on measurement
 $< 0.2^\circ$ on phase
- **Influence of frequency⁽²⁾:**
 $< 0.5\%$ of output signal from 30 Hz .. 48 Hz
 $< 1\%$ of output signal from 65 Hz .. 1 kHz
 $< 2\%$ of output signal from 1 kHz .. 5 kHz

- **Influence of crest factor:**
 $< 1\%$ of output signal for crest factor ≤ 6 with current $\leq 2,000$ A peak (300 A_{RMS})
- **Influence of DC current superimposed on rated current:**
 $< 1\%$ of output signal for a current ≤ 15 A DC

MECHANICAL SPECIFICATIONS

- **Operating temperature:**
-10 °C to +50 °C
- **Storage temperature:**
-40 °C to +70 °C
- **Influence of temperature:**
 $\leq 0.2\%$ of output signal per 10 °C
- **Relative humidity for operation:**
0 to 85 % RH with a linear decrease above 35 °C
- **Influence of relative humidity:**
 $< 0.1\%$ of output signal from 10 % to 85 % RH
- **Operating altitude:**
0 to 2,000 m
- **Max. jaw opening:**
53 mm, patented progressive opening system
- **Clamping capacity:**
Cable: \varnothing max 52 mm
Busbar: 1 busbar of 50 x 5 mm / 4 busbars of 30 x 5 mm
- **Casing protection rating:**
IP40 (IEC 529)
- **Drop test:**
1 m (IEC 68-2-32)
- **Shock resistance:**
100 g (IEC 68-2-27)

- **Vibration resistance:**
5/15 Hz 1.5 mm, 15/25 Hz 1 mm, 25/55 Hz 0.25 mm (IEC 68-2-6)
- **Self-extinguishing capability:**
Casing and jaws: UL94 V0
- **Dimensions:**
216 x 111 x 45 mm
- **Weight:**
550 g
- **Colours:**
Dark grey case with red jaws
- **Output:**
C112: Safety sockets (4 mm)
C113: two-wire cable with reinforced insulation or double insulation, length 1.5 m, terminated by 2 insulated elbowed male banana plugs (4 mm)

SAFETY SPECIFICATIONS

- **Electrical safety:**
Instrument with double insulation or reinforced insulation between the primary the secondary and the grippable part located under the guard as per IEC 1010-1 & IEC 1010-2-032
- 600 V category III, pollution degree 2
- 300 V category IV, pollution degree 2
- **Electromagnetic compatibility (EMC):**
EN 50081-1: class B
EN 50082-2:
- Electrostatic discharge: IEC 1000-4-2
- Radiated field: IEC 1000-4-3
- Fast transients: IEC 1000-4-4
- Magnetic field at 50/60 Hz: IEC 1000-4-8

(1) Conditions of reference: 23 °C \pm 3 °K, 20 % to 75 % RH, signal sinus, frequency of 48 Hz to 65 Hz, distortion factor $< 1\%$, no DC components, external magnetic field < 40 A/m, no AC magnetic field, conductor centred for measurement, load impedance 1Ω (1 VA)

(2) Out of reference domain.

To order	Reference
AC current clamp model C112 with operating manual	P01120314
AC current clamp model C113 with operating manual	P01120315

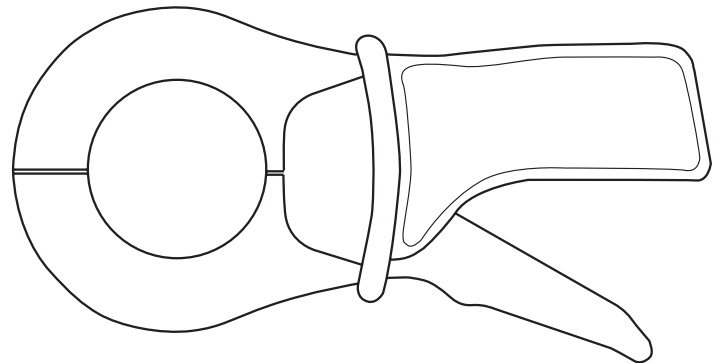

Current clamps for AC current

Models C116 and C117

C100 series

Current	1,000 A
Output	1 mV/A

DESCRIPTION

Thanks to their excellent technical performance (phase shift and linearity), these μ -metal core clamps are highly recommended for wattmeter use.

ELECTRICAL SPECIFICATIONS

- Current range:**
0.001 A AC .. 1,200 A AC
- Output signal:**
1 mVAC/A AC (1 V for 1,000 A)
- Accuracy and phase shift ⁽¹⁾:**

Primary current	1 mA .. 100 mA	0.1 A .. 1 A	1 A .. 10 A	10 A .. 100 A	100 A .. 1,200 A
% Accuracy of output signal	$\leq 3\% + 5 \mu\text{A}$	$\leq 2\% + 3 \mu\text{A}$	$\leq 1\%$	$\leq 0.5\%$	$\leq 0.3\%$
Phase shift	not specified	not specified	$\leq 2^\circ$	$\leq 1^\circ$	$\leq 0.7^\circ$

- Bandwidth:**
30 Hz .. 10 kHz
- Crest factor:**
 ≤ 6 for a current $\leq 2,000$ A peak (300 A_{RMS})
- Maximum currents:**
1,000 A continuous for a frequency ≤ 1 kHz (limitation proportional to the inverse of frequency beyond)
1,200 A for 40 minutes max (interval between measurements > 20 minutes)
- Output impedance:**
 $1 \Omega \pm 1\%$
- Load impedance:**
 $\geq 1 \text{ M}\Omega$ and $\leq 100 \text{ pF}$
- Operating voltage:**
600 V_{RMS}
- Common mode voltage:**
600 V category III and pollution degree 2
- Influence of adjacent conductor:**
 $\leq 0.5 \text{ mA/A}$ at 50 Hz
- Influence of conductor position in jaws:**
 $\leq 0.1\%$ of output signal for frequencies ≤ 400 Hz
- Load influence:**
On receiver, for an input impedance of 100Ω :
 $\leq 1\%$ on measurement, no measurement on phase.
On receiver, for an input impedance of $1 \text{ k}\Omega$:
 $\leq 0.1\%$ on measurement, no measurement on phase.
- Influence of frequency ⁽²⁾:**
 $< 0.5\%$ of output signal from 30 Hz .. 48 Hz
 $< 1\%$ of output signal from 65 Hz .. 1 kHz
 $< 2\%$ of output signal from 1 kHz .. 5 kHz

- Influence of crest factor:**
 $< 1\%$ of output signal for crest factor ≤ 6 with current $\leq 2,000$ A peak
- Influence of DC current superimposed on rated current:**
 $< 1\%$ of output signal for a current ≤ 15 A DC

MECHANICAL SPECIFICATIONS

- Operating temperature:**
 -10°C to $+50^\circ\text{C}$
- Storage temperature:**
 40°C to $+70^\circ\text{C}$
- Influence of temperature:**
 $\leq 0.2\%$ of output signal per 10°K
- Relative humidity for operation:**
0 to 85 % RH decreasing linearly above 35°C
- Influence of relative humidity:**
 $< 0.1\%$ of output signal from 10 % to 85 % RH
- Operating altitude:**
0 to 2,000 m
- Max. jaw opening:**
53 mm
Patented progressive opening system
- Clamping capacity:**
Cable: \emptyset max 52 mm
Busbar: 1 busbar of $50 \times 5 \text{ mm}$ /
4 busbars of $30 \times 5 \text{ mm}$
- Casing protection rating:**
IP40 (IEC 529)
- Drop test:** 1 m (IEC 68-2-32)
- Shock resistance:**
100 g (IEC 68-2-27)

- Vibration resistance:**
5/15 Hz 1.5 mm
15/25 Hz 1 mm
25/55 Hz 0.25 mm
(IEC 68-2-6)
- Self-extinguishing capability:**
Casing and jaws: UL94 V0
- Dimensions:**
216 x 111 x 45 mm
- Weight:**
550 g
- Colours:**
Dark grey case with red jaws
- Output:**
C116: Safety sockets (4 mm)
C117: two-wire cable with reinforced insulation or double insulation, length 1.5 m, terminated by 2 insulated elbowed male banana plugs, \emptyset 4 mm

SAFETY SPECIFICATIONS

- Electrical safety:**
Instrument with double insulation or reinforced insulation between the primary the secondary and the grippable part located under the guard as per IEC 1010-1 & IEC 1010-2-032
- 600 V category III, pollution degree 2
- 300 V category IV, pollution degree 2
- Electromagnetic compatibility (EMC):**
EN 50081-1: class B
EN 50082-2:
- Electrostatic discharge: IEC 1000-4-2
- Radiated field: IEC 1000-4-3
- Fast transients: IEC 1000-4-4
- Magnetic field at 50/60 Hz: IEC 1000-4-8

(1) Conditions of reference: $23^\circ\text{C} \pm 3^\circ\text{K}$, 20 % to 75 % RH, signal sinus, frequency of 48 Hz to 65 Hz, distortion factor $< 1\%$, no DC components, external magnetic field $< 40 \text{ A/m}$, no AC magnetic field, conductor centred for measurement, load impedance $\geq 1 \text{ M}\Omega$ and $\leq 100 \text{ pF}$

(2) Out of reference domain

To order	Reference
AC current clamp model C116 with operating manual	P01120316
AC current clamp model C117 with operating manual	P01120317

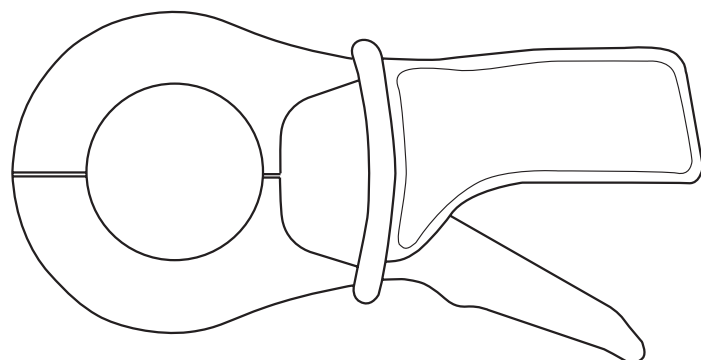

Current clamp for AC current

Model C122

C100 series

Current	1,000 A
Ratio	1000/5
Output	5 mA/A

DESCRIPTION

An electronic voltage-limiting system protects output of clamp when operating, if the secondary circuit is opened accidentally.

ELECTRICAL SPECIFICATIONS

- **Current range:**
1 A AC .. 1,200 A AC
- **Current transformation ratio:**
1000:5
- **Output signal:**
5 mA AC / A AC (5 A for 1,000 A)
- **Accuracy and phase shift ⁽¹⁾:**

Primary current	1 A .. 20 A	20 A	50 A ⁽²⁾	200 A ⁽²⁾	1,000 A ⁽²⁾	1,200 A ⁽²⁾
Accuracy en %	≤ 6% + 0.5 mA	≤ 5%	≤ 3%	≤ 1.5%	≤ 1%	≤ 1%
Phase shift	not specified	≤ 3°	≤ 3°	≤ 1.5°	≤ 1°	≤ 1°

- **Bandwidth:**
30 Hz .. 10 kHz
- **Crest factor:**
≤ 6 for a current ≤ 3,000 A peak (500 A_{RMS})
- **Maximum currents:**
1,000 A continuous for a frequency ≤ 1 kHz (limitation proportional to the inverse of frequency beyond)
1,200 A for 30 minutes max (interval between measurements > 15 minutes)
- **Load impedance:**
≤ 0.6 Ω
- **Impedance of connection leads:**
≤ 40 mΩ
- **Maximum output voltage (secondary open):**
Electronic protection circuit limiting voltage to 30 V peak max
- **Operating voltage:**
600 V_{RMS}
- **Common mode voltage:**
600 V category III and pollution degree 2
- **Influence of adjacent conductor:**
≤ 1 mA/A at 50 Hz
- **Influence of conductor position in jaws:**
≤ 0.2 % of output signal for frequencies ≤ 400 Hz
- **Load influence:**
From 0.2 Ω to 0.6 Ω
< 0.5 % on measurement
< 0.5° on phase
- **Influence of frequency ⁽³⁾:**
< 1 % of output signal from 30 Hz .. 48 Hz
< 0.5 % of output signal from 65 Hz .. 1 kHz
< 1 % of output signal from 1 kHz .. 5 kHz

- **Influence of crest factor:**
< 1 % of output signal for crest factor ≤ 6 with current ≤ 3,000 A peak (500 A_{RMS})
- **Influence of DC current superimposed on rated current:**
< 1 % of output signal for a current ≤ 30 A DC

MECHANICAL SPECIFICATIONS

- **Operating temperature:**
-10 °C to +50 °C
- **Storage temperature:**
-40 °C to +70 °C
- **Influence of temperature:**
≤ 0.1 % of output signal per 10 °K
- **Relative humidity for operation:**
0 to 85 % RH with a linear decrease above 35 °C
- **Influence of relative humidity:**
< 0.2 % of output signal from 10 % to 85 % RH
- **Operating altitude:**
0 to 2,000 m
- **Max. jaw opening:**
53 mm
Patented progressive opening system
- **Clamping capacity:**
- Cable: Ø max 52 mm
- Busbar: 1 busbar of 50 x 5 mm / 4 busbars of 30 x 5 mm
- **Casing protection rating:**
IP40 (IEC 529)
- **Drop test:**
1 m (IEC 68-2-32)

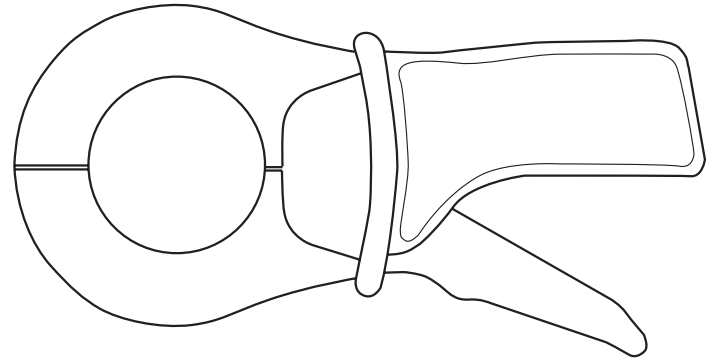

- **Shock resistance:**
100 g (IEC 68-2-27)
- **Vibration resistance:**
5/15 Hz 1.5 mm
15/25 Hz 1 mm
25/55 Hz 0.25 mm (IEC 68-2-6)
- **Self-extinguishing capability:**
Casing and jaws: UL94 V0
- **Dimensions:**
216 x 111 x 45 mm
- **Weight:**
550 g
- **Colours:**
Dark grey case with red jaws
- **Output:**
Safety sockets (4 mm)

SAFETY SPECIFICATIONS

- **Electrical safety:**
Instrument with double insulation or reinforced insulation between the primary the secondary and the grippable part located under the guard as per IEC 1010-1 & IEC 1010-2-032
- 600 V category III, pollution degree 2
- 300 V category IV, pollution degree 2
- **Electromagnetic compatibility (EMC):**
EN 50081-1: class B
EN 50082-2:
- Electrostatic discharge: IEC 1000-4-2
- Radiated field: IEC 1000-4-3
- Fast transients: IEC 1000-4-4
- Magnetic field at 50/60 Hz: IEC 1000-4-8

(1) Conditions of reference: 23 °C ± 3 °K, 20 % to 75 % RH, signal sinus, frequency of 48 Hz to 65 Hz, distortion factor < 1 %, no DC components, external magnetic field < 40 A/m, no AC magnetic field, conductor centred for measurement, load impedance 0.2 Ω (5 VA)

(2) Accuracy class in accordance with IEC 185: 5 VA - class 1 - 48 .. 65 Hz

(3) Out of reference domain

To order	Reference
AC current clamp model C122 with operating manual	P01120306

Current clamp for AC current

Model C148

C100 series

Current	250 A AC	500 A AC	1,000 A AC
Ratio	250:5	500:5	1000:5
Output	20 mA/A	10 mA/A	5 mA/A

DESCRIPTION

An electronic voltage-limiting system protects output of clamp when operating if the secondary circuit is opened accidentally.

ELECTRICAL SPECIFICATIONS

- **Current range:**
1 A AC .. 300 A AC
1 A AC .. 600 A AC
1 A AC .. 1,200 A AC
- **Current transformation ratio**
250:5
500:5
1000:5
- **Output signal:**
20 mA AC / A AC (5 A for 250 A)
10 mA AC / A AC (5 A for 500 A)
5 mA AC / A AC (5 A for 1,000 A)

- **Accuracy and phase shift ⁽¹⁾:**

- 250 A calibre

Primary current	1 A .. 5 A	5 A	12,5 A ⁽²⁾	50 A ⁽²⁾	250 A ⁽²⁾	300 A ⁽²⁾
Accuracy en %	≤ 10 % + 2 mA	≤ 10 %	≤ 5 %	≤ 2.5 %	≤ 2 %	≤ 2 %
Phase shift	not specified	not specified	≤ 10°	≤ 10°	≤ 10°	≤ 10°

- 500 A calibre

Primary current	1 A .. 10 A	10 A	25 A ⁽³⁾	100 A ⁽³⁾	500 A ⁽³⁾	600 A ⁽³⁾
Accuracy en %	≤ 6 % + 1 mA	≤ 6 %	≤ 3 %	≤ 2 %	≤ 1 %	≤ 1 %
Phase shift	not specified	≤ 6°	≤ 4°	≤ 3°	≤ 2.5°	≤ 2.5°

- 1,000 A calibre

Primary current	1 A .. 20 A	20 A	50 A ⁽⁴⁾	200 A ⁽⁴⁾	1,000 A ⁽⁴⁾	1,200 A ⁽⁴⁾
Accuracy en %	≤ 6 % + 0.5 mA	≤ 5 %	≤ 3 %	≤ 1.5 %	≤ 1 %	≤ 1 %
Phase shift	not specified	≤ 5°	≤ 3°	≤ 1.5°	≤ 1°	≤ 1°

- **Bandwidth:**
48 Hz .. 1 kHz
- **Crest factor:**
 - 250 A calibre:
≤ 6 with current ≤ 750 A peak
 - 500 A calibre:
≤ 6 with current ≤ 1,500 A peak
 - 1,000 A calibre:
≤ 6 with current ≤ 3,000 A peak
- **Maximum currents:**
1,200 A for frequencies ≤ 1 kHz for 30 minutes max (interval between measurements > 15 minutes)
- **Load impedance:**
 - 250 A calibre: ≤ 0.2 Ω
 - 500 A calibre: ≤ 0.4 Ω
 - 1,000 A calibre: ≤ 0.4 Ω
- **Impedance of connection leads:**
≤ 40 mΩ

- **Maximum output voltage (secondary open):**
Electronic protection circuit limiting voltage to 30 V peak max
- **Operating voltage:**
600 V_{RMS}
- **Common mode voltage:**
600 V category III and pollution degree 2
- **Influence of adjacent conductor:**
 - 250 A calibre: ≤ 15 mA/A at 50 Hz
 - 500 A calibre: ≤ 10 mA/A at 50 Hz
 - 1,000 A calibre: ≤ 1 mA/A at 50 Hz
- **Influence of conductor position in jaws:**
For frequencies ≤ 400 Hz
 - 250 A calibre: ≤ 0.6 % of output signal
 - 500 A calibre: ≤ 0.4 % of output signal
 - 1,000 A calibre: ≤ 0.2 % of output signal

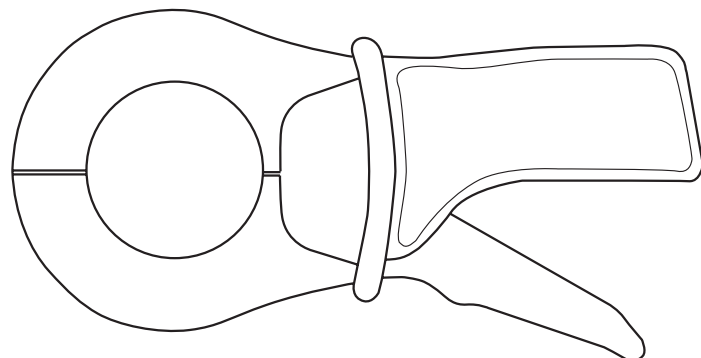

- **Load influence:**
 - 250 A calibre: from 25 mΩ to 0.2 Ω
< 2 % on measurement
< 4° on phase
 - 500 A calibre: from 50 mΩ to 0.4 Ω
< 1 % on measurement
< 2° on phase
 - 1,000 A calibre: from 50 mΩ to 0.4 Ω
< 0.5 % on measurement
< 0.5° on phase
- **Influence of frequency ⁽⁵⁾:**
 - 250 A calibre:
< 1 % of output signal from 65 Hz .. 100 Hz
< 5 % of output signal from 100 Hz .. 1 kHz
 - 500 A calibre:
< 1 % of output signal from 65 Hz .. 1 kHz
 - 1,000 A calibre:
< 0.5 % of output signal from 65 Hz .. 100 Hz
< 1 % of output signal from 100 Hz .. 1 kHz
- **Influence of crest factor:**
< 1 % of output signal for crest factor ≤ 6 with current:
≤ 750 A peak (calibre 250 A)
≤ 1,500 A peak (calibre 500 A)
≤ 3,000 A peak (1,000 A calibre)
- **Influence of DC current superimposed on rated current:**
< 1 % of output signal for a current ≤ 30 A DC



MECHANICAL SPECIFICATIONS

- **Operating temperature:**
-10 °C to +50 °C
- **Storage temperature:**
-40 °C to +70 °C
- **Influence of temperature:**
≤ 0.15 % of output signal per 10 °K
- **Relative humidity for operation:**
0 to 85 % RH decreasing linearly above 35 °C
- **Influence of relative humidity:**
From 10 % to 85 % RH
 - 250 A calibre:
< 0.6 % of output signal and < 2° on phase
 - 500 A calibre:
< 0.4 % of output signal and < 0.6° on phase
 - 1,000 A calibre:
< 0.2 % of output signal and < 0.2° on phase
- **Operating altitude:**
0 to 2,000 m
- **Max. jaw opening:**
53 mm
Patented progressive opening system

- **Clamping capacity:**
Cable: Ø max 52 mm
Busbar: 1 busbar of 50 x 5 mm /
4 busbars of 30 x 5 mm
- **Casing protection rating:**
IP40 (IEC 529)
- **Drop test:**
1 m (IEC 68-2-32)
- **Shock resistance:**
100 g (IEC 68-2-27)
- **Vibration resistance:**
5/15 Hz 1.5 mm
15/25 Hz 1 mm
25/55 Hz 0.25 mm
(IEC 68-2-6)
- **Self-extinguishing capability:**
UL94 V0
- **Dimensions:**
216 x 111 x 45 mm
- **Weight:**
550 g
- **Colours:**
Dark grey case with red jaws
- **Output:**
Safety jacks (4 mm)

SAFETY SPECIFICATIONS

- **Electrical safety:**
Instrument with double insulation or reinforced insulation between the primary the secondary and the grippable part located under the guard as per IEC 1010-1 & IEC 1010-2-032
 - 600 V category III, pollution degree 2
 - 300 V category IV, pollution degree 2
- **Electromagnetic compatibility (EMC):**
EN 50081-1: class B
EN 50082-2:
 - Electrostatic discharge: IEC 1000-4-2
 - Radiated field: IEC 1000-4-3
 - Fast transients: IEC 1000-4-4
 - Magnetic field at 50/60 Hz: IEC 1000-4-8

(1) Conditions of reference: 23 °C ± 3 °K, 20 % to 75 % RH, signal sinus, frequency of 48 Hz to 65 Hz, distortion factor < 1 %, external magnetic field < 40 A/m, no AC magnetic field, conductor centred for measurement, load impedance:
- 250 A calibre: 0.1 Ω (2.5 VA)
- 500 A calibre: 0.2 Ω (5 VA)
- 1,000 A calibre: 0.2 Ω (5 VA)

(2) Accuracy class in accordance with IEC 185: 2.5 VA - class 3 - 48-65 Hz

(3) Accuracy class in accordance with IEC 185: 5 VA - class 3 - 48-65 Hz

(4) Accuracy class in accordance with IEC 185: 5 VA - class 1 - 48-65 Hz

(5) Out of reference domain

To order	Reference
AC current clamp model C148 with operating manual	P01120307

Model C160 (insulated AC current probe)

Current	30 A peak	300 A peak	2,000 A peak
Output	100 mV/A	10 mV/A	1 mV/A

DESCRIPTION

This 1,000 A AC clamp can be used for easy display and measurement of current curves. Equipped with a coaxial cable terminated by a BNC connector, it is ideal for use with any oscilloscope. It outputs a signal in mV directly proportional to the current. It offers 3 different sensitivities.

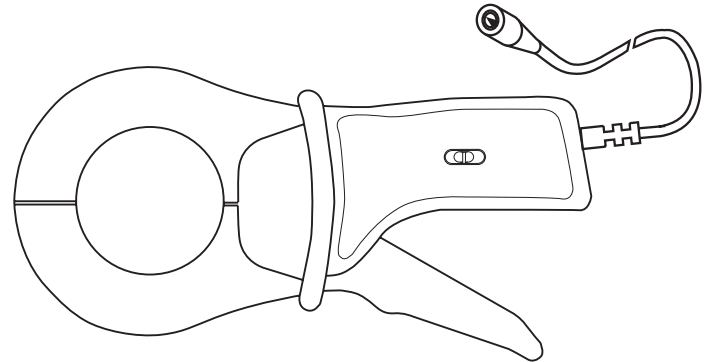

ELECTRICAL SPECIFICATIONS

- **Current range:**
0.1 A AC .. 10 A AC (30 A peak)
1 A AC .. 100 A AC (300 A peak)
1 A AC .. 1,000 A AC (2,000 A peak)

- **Output signal:**
100 mV AC / A AC (1 V for 10 A)
10 mV AC / A AC (1 V for 100 A)
1 mA AC / A AC (1 V for 1,000 A)

- **Accuracy and phase shift ⁽¹⁾:**

- 10 A calibre

Primary current	0.1 A .. 0.5 A	0.5 A .. 2 A	2 A .. 10 A	10 A .. 12 A
% Accuracy of output signal	≤ 3% + 10 mV	≤ 3% + 10 mV	≤ 3% + 10 mV	≤ 3% + 10 mV
Phase shift	not specified	not specified	≤ 15°	≤ 15°

- 100 A calibre

Primary current	0.1 A .. 5 A	5 A .. 20 A	20 A .. 100 A	100 A .. 120 A
% Accuracy of output signal	≤ 2% + 5 mV	≤ 2% + 5 mV	≤ 2% + 5 mV	≤ 2% + 5 mV
Phase shift	not specified	≤ 15°	≤ 10°	≤ 5°

- 1,000 A calibre

Primary current	1 A .. 50 A	50 A .. 200 A	200 A .. 1,000 A	1,000 A .. 1,200 A
% Accuracy of output signal	≤ 1% + 1 mV	≤ 1% + 1 mV	≤ 1% + 1 mV	≤ 1% + 1 mV
Phase shift	not specified	≤ 3°	≤ 2°	≤ 1°

- **Bandwidth:**
10 Hz .. 100 kHz (-3 dB)
(depending on current value)
- **Rise/fall time from 10 % to 90 %:**
3.5 μs
- **10 % delay time:**
0.5 μs
- **Ampere second product:**
 - 10 A calibre: 3.2 A.s
 - 100 A calibre: 26 A.s
 - 1,000 A calibre: 64 A.s

- **Maximum currents:**
1,000 A permanent
1,200 A for 40 minutes max. / > 20 minutes shutdown for a frequency ≤ 1 kHz (limitation proportional to the inverse of one third of the frequency beyond that)
- **Insertion impedance (at 400 Hz / 10 kHz)**
 - 10 A calibre: < 0.3 mΩ / < 6.6 mΩ
 - 100 A calibre: < 0.3 mΩ / < 2 mΩ
 - 1,000 A calibre: < 0.3 mΩ / < 1.6 mΩ
- **Output impedance at 1 kHz:**
 - 10 A calibre: ≤ 515 Ω ± 10 %
 - 100 A calibre: ≤ 515 Ω ± 10 %
 - 1,000 A calibre: ≤ 515 Ω ± 10 %

- **Influence of temperature:**
≤ 150 ppm / k or 0.15 % of output signal per 10 °K
- **Influence of relative humidity:**
< 0.1 % of output signal
- **Influence of adjacent conductor:**
≤ 1 mA / A at 50 Hz
- **Influence of DC current ≤ 30 A superimposed on rated current:**
< 1 %
- **Influence of conductor position in jaws:**
≤ 0.1 % of output signal for frequencies ≤ 400 Hz
- **Influence of frequency ⁽²⁾:**
 - 10 A calibre:
< 10 % of output signal from 10 Hz .. 1 kHz
< 5 % of output signal from 1 kHz .. 10 kHz
< 20 % of output signal from 10 kHz .. 50 kHz
3 dB of output signal from 50 kHz .. 100 kHz
 - 100 A calibre:
< 5 % of output signal from 10 Hz .. 1 kHz
< 3 % of output signal from 1 kHz .. 10 kHz
< 20 % of output signal from 10 kHz .. 50 kHz
3 dB of output signal from 50 kHz .. 100 kHz
 - 1,000 A calibre:
< 1 % of output signal from 10 Hz .. 1 kHz
< 2 % of output signal from 1 kHz .. 10 kHz
< 10 % of output signal from 10 kHz .. 50 kHz
3 dB of output signal from 50 kHz .. 100 kHz
- **Influence of crest factor:**
< 1 % of output signal for crest factor ≤ 6 with current
 - 10 A calibre: ≤ 30 A peak
 - 100 A calibre: ≤ 300 A peak
 - 1,000 A calibre: ≤ 3,000 A peak

MECHANICAL SPECIFICATIONS

- **Max. jaw opening:**
53 mm
- **Clamping capacity:**
Cable: Ø max 52 mm
Busbar: 1 busbar of 50 x 5 mm/
4 busbars of 30 x 5 mm
- **Operating temperature:**
-10 °C to +55 °C
- **Storage temperature:**
-40 °C to +70 °C
- **Relative humidity for operation:**
0 to 85 % RH decreasing linearly above 35 °C
- **Operating altitude:**
0 to 2,000 m
- **Casing protection rating:**
IP30 with clamp open (IEC 529)
IP40 with clamp closed (IEC 529)
- **Drop test:**
1 m (IEC 68-2-32)

- **Shock resistance:**
100 g / 6 ms / half-period (IEC 68-2-27)
- **Protection against impacts:**
IK04 0.5 J (EN 50102)
- **Vibration resistance:**
5/15 Hz 1.5 mm peak
15/25 Hz 1 mm peak
25/55 Hz 0.25 mm peak
(IEC 68-2-6)
- **Self-extinguishing capability:**
Casing and jaws: UL94 V0
- **Dimensions:**
216 x 111 x 45 mm
- **Weight:**
550 g
- **Colours:**
Dark grey case with red jaws
- **Output:**
Via 2 m coaxial cable terminated by insulated BNC plug

SAFETY SPECIFICATIONS

- **Electrical safety:**
Instrument with double insulation or reinforced insulation between the primary the secondary and the grippable part located under the guard as per IEC 1010-1 & IEC 1010-2-032
- 600 V category III, pollution degree 2
- 300 V category IV, pollution degree 2
- **Electromagnetic compatibility (EMC):**
EN 50081-1: class B
EN 50082-2:
- Electrostatic discharge: IEC 1000-4-2
without disturbance: 4 kV class 2
non-destructive: 15 kV class 4
- Radiated field: IEC 1000-4-3
without disturbance: 10 V/m performance criterion A
- Fast transients: IEC 1000-4-4
without disturbance: 1 kV class 2
non-destructive: 2 kV class 3
- Magnetic field at 50/60 Hz: IEC 1000-4-8
field of 400 A/m at 50 Hz: < 1 A

(1) Conditions of reference: 23 °C ± 3 °K, 20 % to 75 % RH, signal sinus, frequency of 48 Hz à 1,000 Hz, distortion factor < 1 % with no DC component, external magnetic field < 40 A/m, no DC components, no external conductor with circulating current, conductor centred for measurement, load impedance: ≥ 1 MΩ and < 100 pF

(2) Out of reference domain

To order	Reference
AC current clamp model C160 with operating manual	P01120308

CURVES AT 50 Hz

1,000 A calibre

Error on measurement

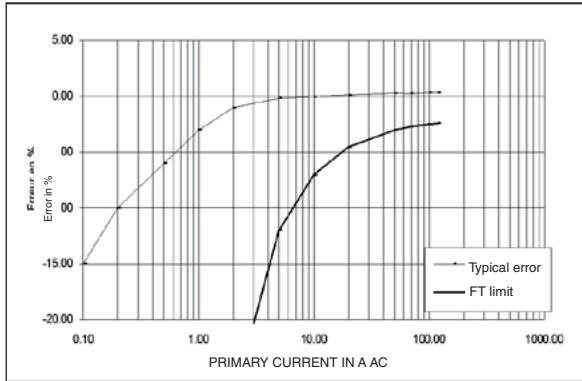

Phase shift

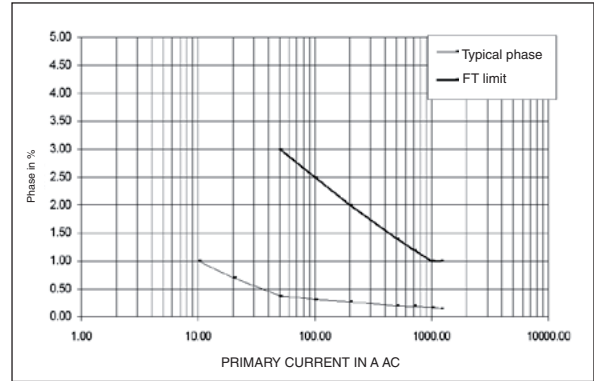

100 A calibre

Error on measurement

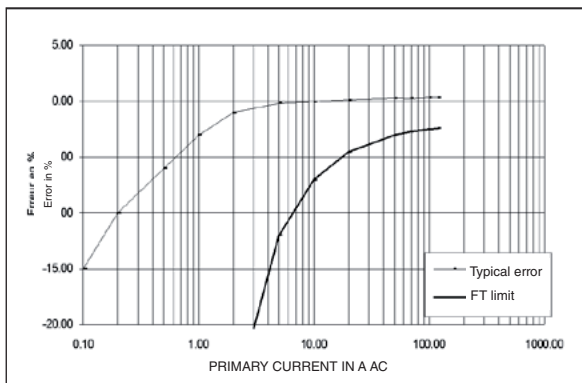

Phase shift

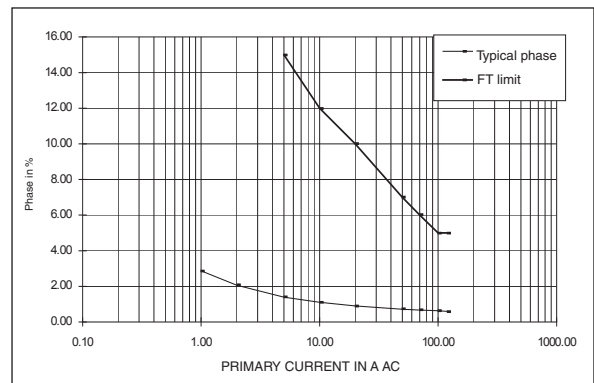

10 A calibre

Error on measurement

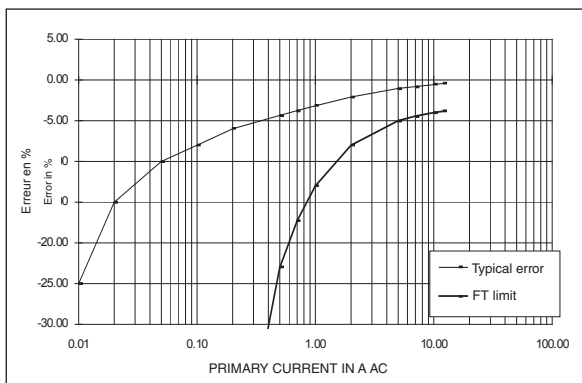

Phase shift

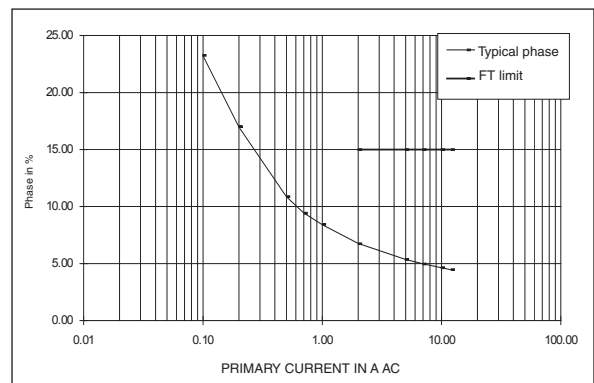

FREQUENCY RESPONSE (CONT.)

1,000 A calibre

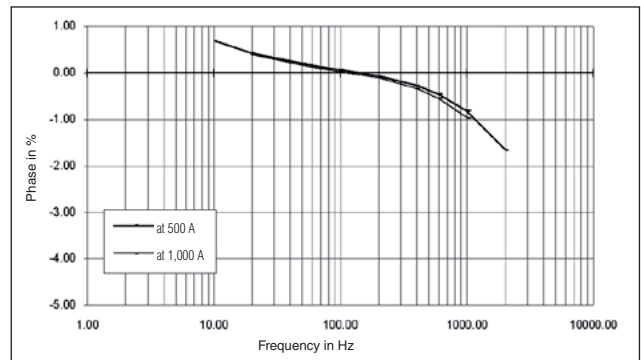
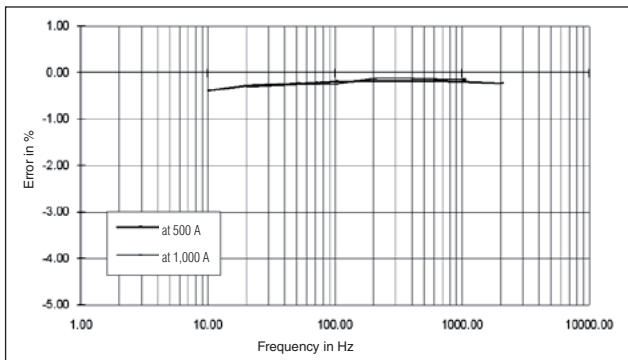
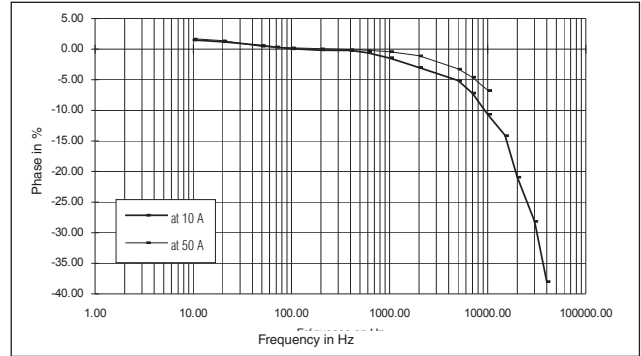
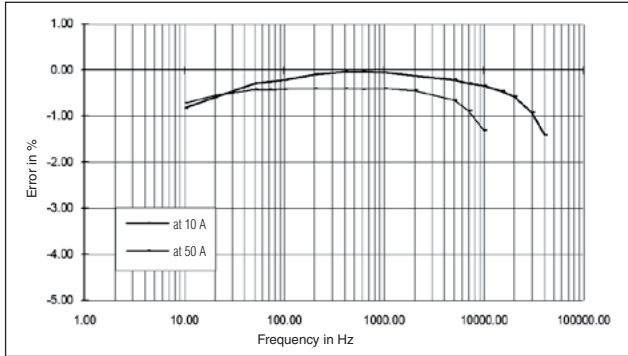

100 A calibre

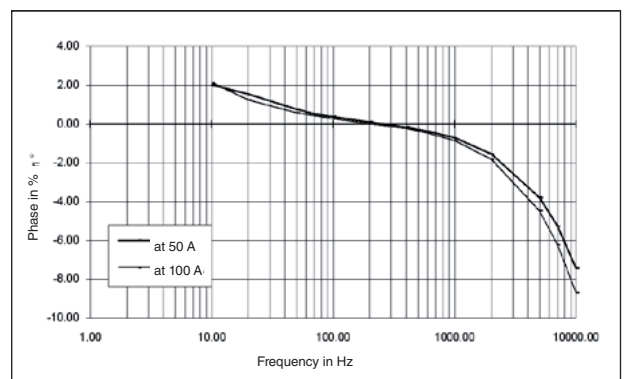
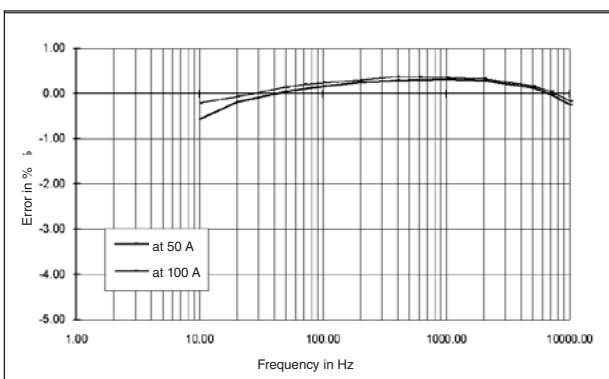
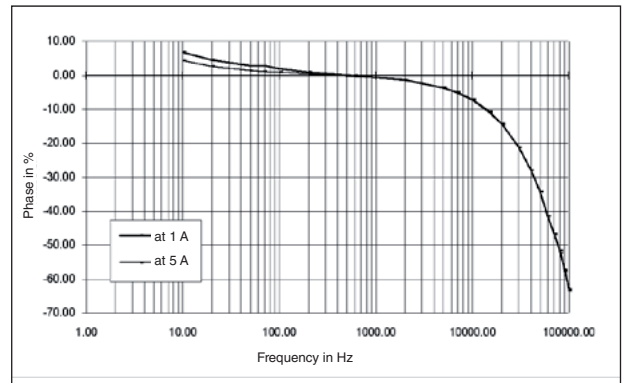
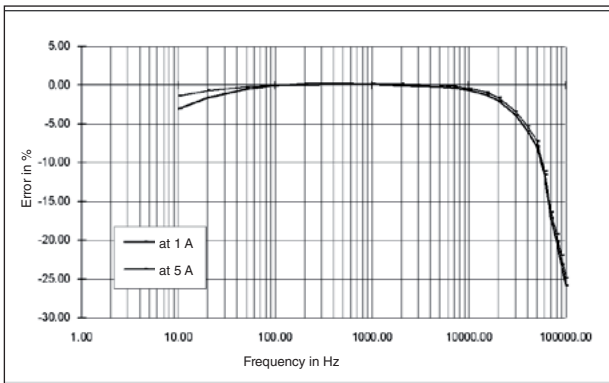

FREQUENCY RESPONSE (CONT.)

10 A calibre

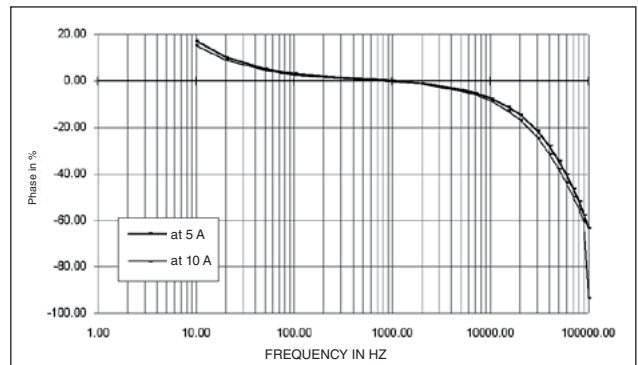
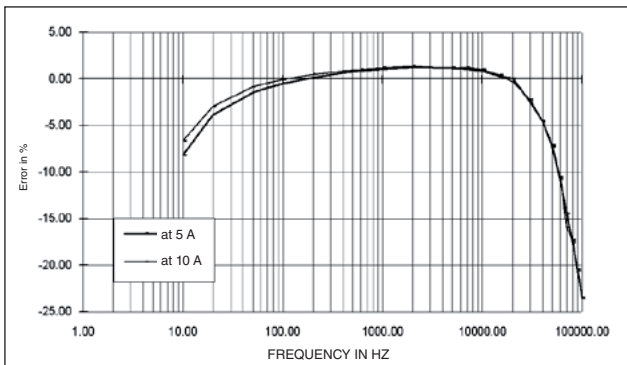
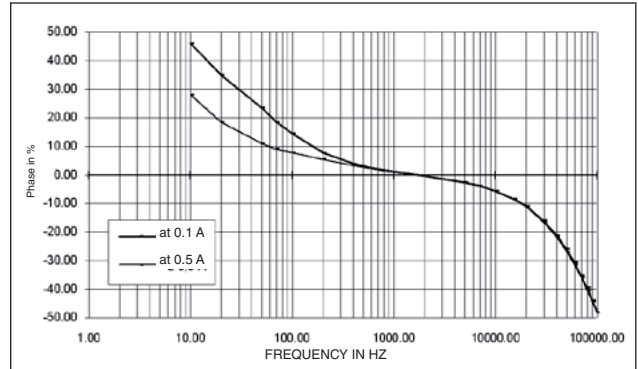
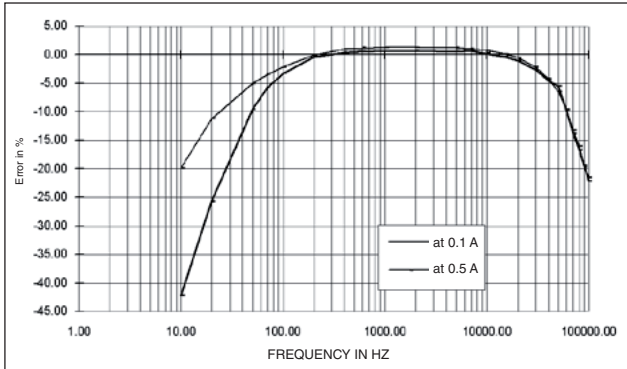

RESPONSE TO A SQUARE SIGNAL

1,000 A calibre

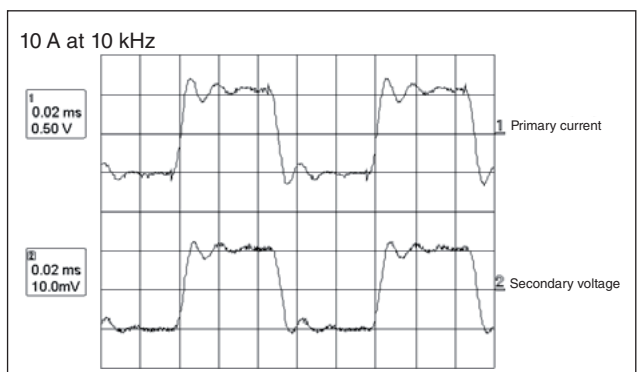
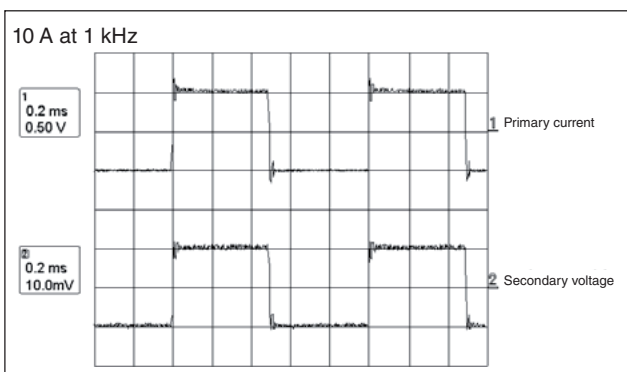
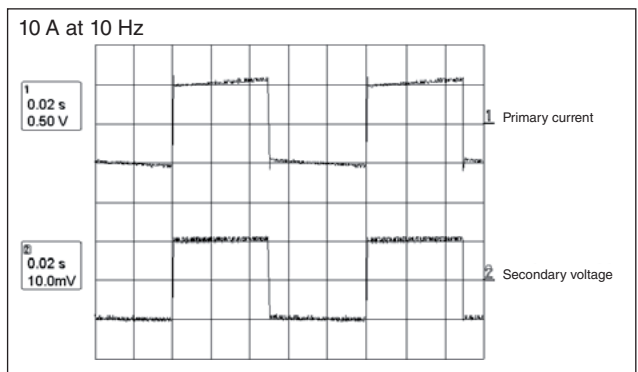
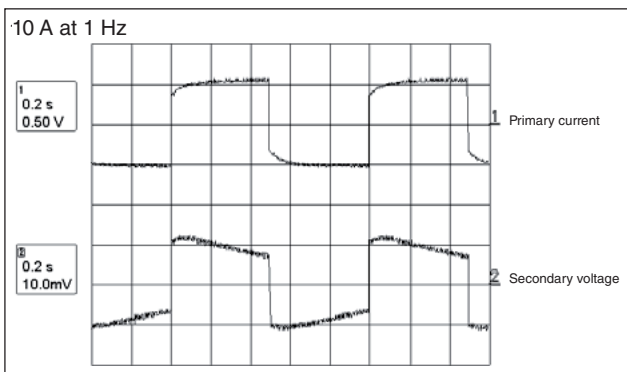

RESPONSE TO A SQUARE SIGNAL (CONT.)

100 A calibre

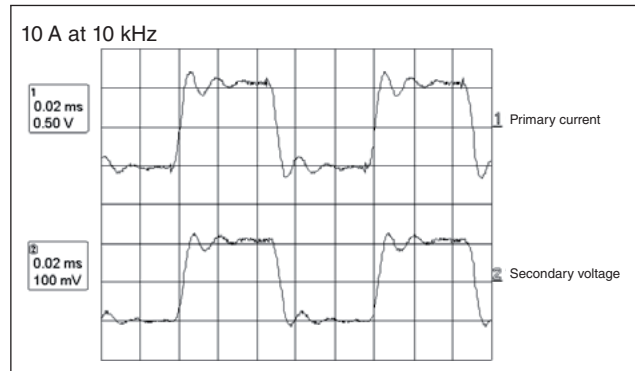
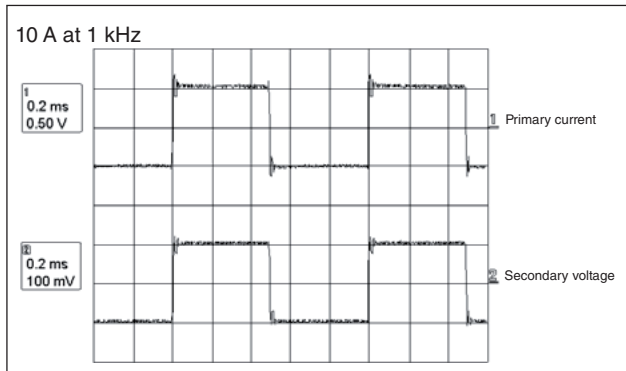
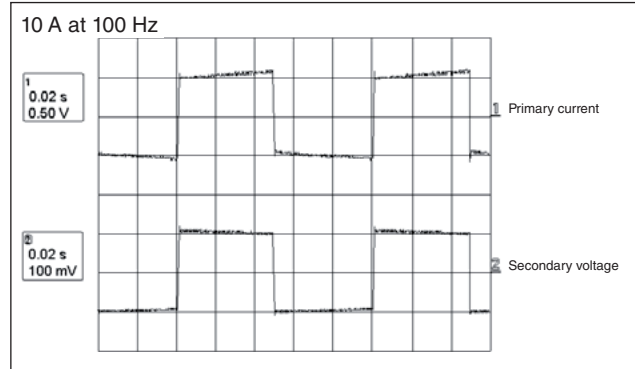
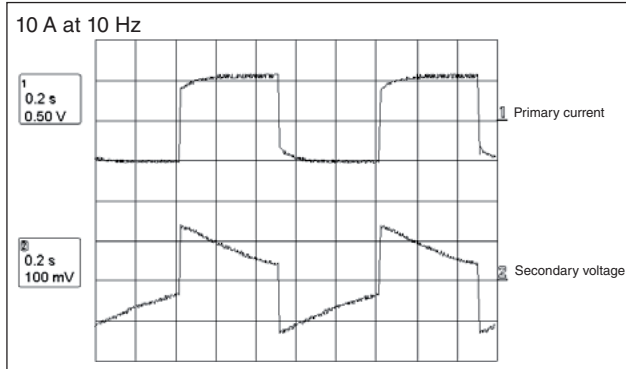

10 A calibre

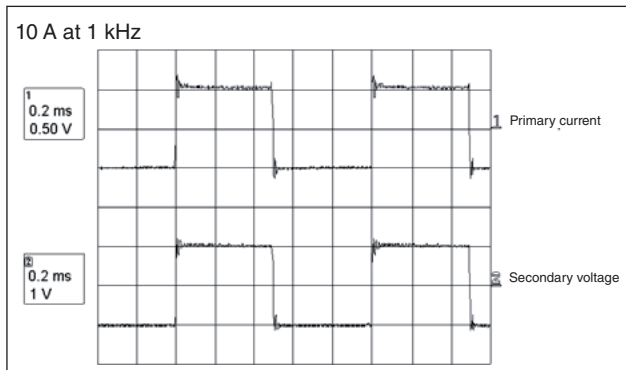
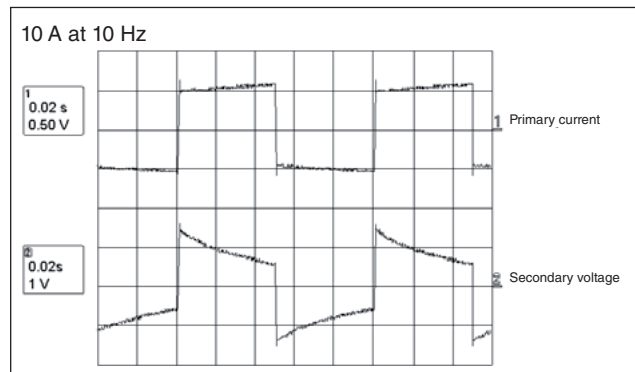
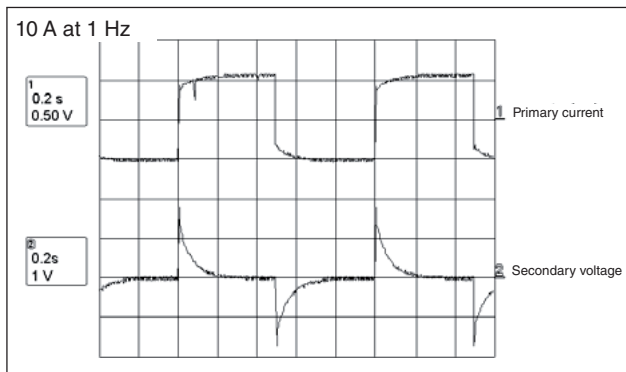

Current clamp for AC current

Model C173 (probe for leakage currents)

C100 series

Current	1 A	10 A	100 A	1,000 A
Output	1 V/A	100 mV/A	10 mV/A	1 mV/A

DESCRIPTION

The C173 clamp measures leakage or differential currents from 1 mA upwards and can also be used with multimeters equipped with a range in mV AC. The C173 clamp measures earth-loop currents and leakage currents. It also locates faults in circuits of single and three-phase networks. For unearthed three-phase systems, use the optional Artificial Neutral.

ELECTRICAL SPECIFICATIONS

- **Current range:**
0.001 A AC .. 1.2 A AC
0.01 A AC .. 12 A AC
0.1 A AC .. 120 A AC
1 A AC .. 1,200 A AC
- **Output signal:**
1 VAC/A AC (1 V for 1 A)
100 mVAC/A AC (1 V for 10 A)
10 mVAC/A AC (1 V for 100 A)
1 mVAC/A AC (1 V for 1,000 A)
- **Accuracy and phase shift⁽¹⁾:**

- 1 A calibre

Primary current	0.001 A .. 0.01 A	0.01 A .. 0.1 A	0.1 A .. 1 A	1 A .. 1.2 A
% Accuracy of output signal	≤ 3% + 1 mV	≤ 3% + 1 mV	≤ 0.7% + 1 mV	≤ 0.7% + 1 mV
Phase shift	not specified	not specified	≤ 10°	≤ 10°

- 10 A calibre

Primary current	0.01 A .. 0.1 A	0.1 A .. 1 A	1 A .. 10 A	10 A .. 12 A
% Accuracy of output signal	≤ 1% + 0.2 mV	≤ 0.5% + 0.2 mV	≤ 0.5%	≤ 0.5%
Phase shift	not specified	≤ 5°	≤ 2°	≤ 2°

- 100 A calibre

Primary current	0.1 A .. 1 A	1 A .. 10 A	10 A .. 100 A	100 A .. 120 A
% Accuracy of output signal	≤ 1% + 0.2 mV	≤ 0.5% + 0.2 mV	≤ 0.3%	≤ 0.2%
Phase shift	not specified	≤ 2°	≤ 1°	≤ 1°

- 1,000 A calibre

Primary current	1 A .. 10 A	10 A .. 100 A	100 A .. 1,000 A	1,000 A .. 1,200 A
% Accuracy of output signal	≤ 1% + 0.2 mV	≤ 0.5% + 0.2 mV	≤ 0.2%	≤ 0.2%
Phase shift	not specified	≤ 2°	≤ 1°	≤ 1°

- **Bandwidth:**
10 Hz .. 3 kHz
- **Crest factor:**
 - 1 A calibre:
≤ 3 for I ≤ 3 A peak (1 A_{RMS})
 - 10 A calibre:
≤ 3 for I ≤ 30 A peak (10 A_{RMS})
 - 100 A calibre:
≤ 3 for I ≤ 300 A peak (100 A_{RMS})
 - 1,000 A calibre:
≤ 3 for I ≤ 1700 A peak (500 A_{RMS})

- **Maximum currents:**
1,000 A continuous for a frequency ≤ 500 Hz (limitation proportional to the inverse of 1/2 of frequency beyond)
- **Load impedance:**
≥ 10 MΩ and ≤ 47 pF
- **Output impedance:**
 - 1 A calibre: 10 kΩ ± 10%
 - 10 A calibre: 1 kΩ ± 10%
 - 100 A calibre: 100 Ω ± 10%
 - 1,000 A calibre: 100 Ω ± 10%

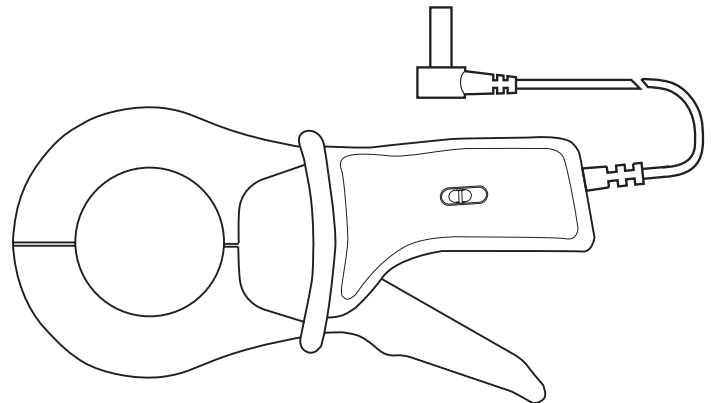

- **Operating voltage:**
600 V_{RMS}
- **Common mode voltage:**
600 V category III and pollution degree 2
- **Influence of adjacent conductor:**
≤ 1 mA/A at 50 Hz
- **Influence of conductor position in jaws:**
≤ 0.3% of output signal for frequencies ≤ 400 Hz
- **Influence of frequency⁽²⁾:**
 - 1 A calibre:
< 2% of output signal 30 Hz .. 48 Hz and 65 Hz .. 1 kHz
< 10% of output signal 1 kHz .. 3 kHz
 - 10 A calibre:
< 2% of output signal 10 Hz .. 48 Hz and 65 Hz .. 3 kHz
 - 100 A calibre:
< 1.5% of output signal 10 Hz .. 48 Hz and 65 Hz .. 3 kHz
 - 1,000 A calibre:
< 1% of output signal 10 Hz .. 48 Hz and 65 Hz .. 1 kHz
- **Influence of crest factor:**
≤ 0.5% for crest factor limited to 3
- **Influence of DC current superimposed on rated current:**
≤ 10% at 1,000 A for a current DC from 10 A

MECHANICAL SPECIFICATIONS

- **Operating temperature:**
-10 °C .. +50 °C
- **Storage temperature:**
-40 °C .. +70 °C
- **Influence of temperature:**
≤ 0.15 % of output signal per 10 °K from -10 °C .. +40 °C
≤ 0.2 % of output signal per 10 °K from +40 °C .. +50 °C
- **Relative humidity for operation:**
From 0 .. 85 % from RH decreasing linearly above 35 °C
- **Influence of relative humidity:**
< 0.1 % of output signal from 10 .. 85 % from RH
- **Operating altitude:**
0 to 2,000 m
- **Max. jaw opening:**
53 mm
Patented progressive opening system

- **Clamping capacity:**
Cable: Ø max 52 mm
Busbar: 1 busbar of 50 x 5 mm or 4 busbars of 30 x 5 mm
- **Casing protection rating:**
IP40 (IEC 529)
- **Drop test:**
1 m (IEC 68-2-32)
- **Shock resistance:**
100 g (IEC 68-2-27)
- **Vibration resistance:**
5/15 Hz 1.5 mm
15/25 Hz 1 mm
25/55 Hz 0.25 mm (IEC 68-2-6)
- **Self-extinguishing capability:**
UL94 V0
- **Dimensions:**
216 x 111 x 45 mm
- **Weight:**
550 g

- **Colours:**
Dark grey case with red jaws
- **Output:**
1.5 m two-wire lead with double or reinforced insulation terminated by 2 elbowed male safety plugs (4 mm)

SAFETY SPECIFICATIONS

- **Electrical safety:**
Instrument with double insulation or reinforced insulation between the primary the secondary and the grippable part located under the guard as per IEC 1010-1 & IEC 1010-2-032
- 600 V category III, pollution degree 2
- 300 V category IV, pollution degree 2
- **Electromagnetic compatibility (EMC):**
EN 50081-1: class B
EN 50082-2:
- Electrostatic discharge: IEC 1000-4-2
- Radiated field: IEC 1000-4-3
- Fast transients: IEC 1000-4-4
- Magnetic field at 50/60 Hz: IEC 1000-4-8

(1) Conditions of reference: 23 °C ± 3 °K, 20 % to 75 % RH, signal sinus, frequency of 48 Hz to 65 Hz, distortion factor < 1 %, no DC components, external magnetic field < 40 A/m, no AC magnetic field, conductor centred for measurement, load impedance: ≥ 10 MΩ and ≤ 47 pF

(2) Out of reference domain

To order	Reference
AC current clamp model C173 with operating manual	P01120309
Accessory: AN1 artificial neutral box (see chapter 12) Bag n°11	P01197201 P01100120



D_N SERIES

The D_N series comprises a range of high-performance clamp-on AC current probes designed for high current measurements. Their excellent current transformation ratios and low phase shift, combined with a broad frequency response, allows highly accurate current and power measurements. High-quality magnetic cores and windings mean high precision current measurement up to 3,000 A (AC). The rectangular jaws can be used to clamp large-diameter cables or busbars.

The D_N series clamps provide true RMS measurement values and faithful signal reproduction.

There are two different kinds of model available in the D_N series: the first acts as a traditional current transformer with a current output (mA) and has a wide range of voltage ratios.

These clamps may also be used with multimeters, harmonic and power measurement equipment, logging apparatus or other instruments allowing AC current input.

The second type of model gives a voltage output in precise proportion to the measured current (1 mV/A, 10 mV/A or 100 mV/A) so you can display and log currents on instruments without current inputs.

Model D38N has been specifically designed for use with oscilloscopes, or other instruments with a BNC input.

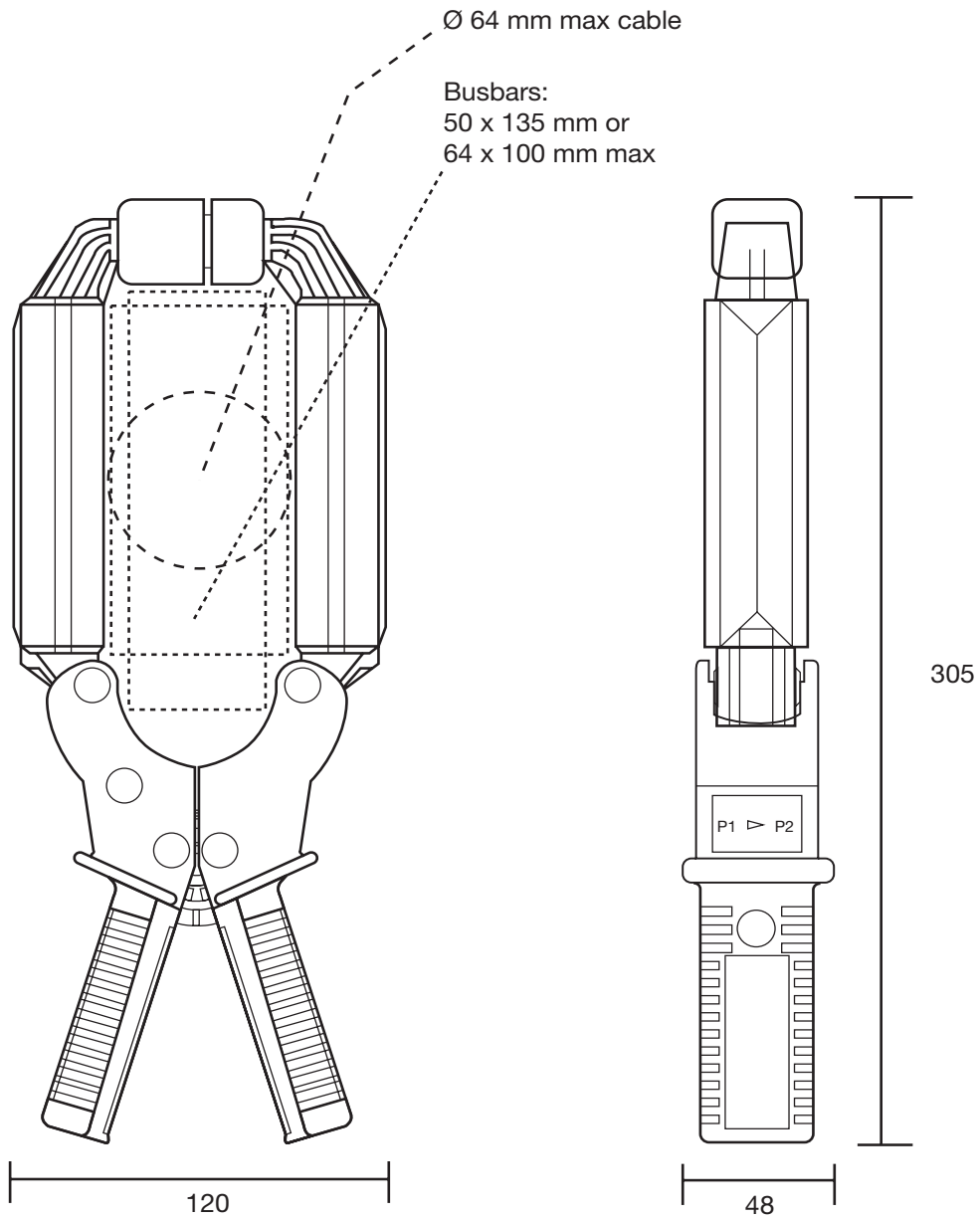

Current clamps for AC current

Models D30N and D30CN

D_N series

Current	2,400 A AC
Ratio	3000:1
Output	0.333 mA/A

ELECTRICAL SPECIFICATIONS

- **Current range:**
1 A AC .. 2,400 A AC
(3,000 A for temperature < 35 °C)
- **Current transformation ratio:**
3000:1
- **Output signal:**
0.333 mA/A AC (1 A to 3,000 A)
- **Accuracy and phase shift ⁽¹⁾:**

Primary current	150 A	600 A	3,000 A
% Accuracy of output signal	1.5 %	0.75 %	0.5 %
Phase shift	1.5°	0.75°	0.5°

- **Overload:**
3600 A for 5 minutes
- **Maximum output voltage (secondary open):**
Electronic protection circuit limiting voltage to 42 V peak max.
- **Accuracy:**
In accordance with IEC 185-26-27, 5 VA, class 0.5 from 48 Hz to 1,000 Hz
- **Bandwidth:**
30 Hz to 5 kHz (in continuous use above 1 kHz, the max. measurement current is limited)
- **Ampere second product:**
90 A.s
- **Load impedance:**
< 5 Ω
- **Operating voltage:**
600 V AC
- **Common mode voltage:**
600 V AC
- **Influence of adjacent conductor:**
0.005 A/A AC
- **Influence of conductor position in jaws:**
1 % ± 0.1 A

MECHANICAL SPECIFICATIONS

- **Operating temperature:**
-10 °C to +50 °C
- **Storage temperature:**
-25 °C to +80 °C
- **Influence of temperature:**
< 0.1 % per 10 °K
- **Max. jaw opening:**
90 mm
- **Max. jaw insertion capacity:**
Cable: 64 mm
Group of wires: 50 x 135 mm - 64 x 100 mm
- **Casing protection rating:**
IP20 in accordance with IEC 529
- **Drop test:**
500 mm (IEC 68-2-32)
- **Shock resistance:**
100 g, in accordance with IEC 68-2-27
- **Vibration resistance:**
10/55/10 Hz, 0.15 mm test in accordance with IEC 68-2-6
- **Self-extinguishing capability:**
Casing: UL94 V0
Jaws: UL94 V2
- **Dimensions:**
120 x 315 x 48 mm
- **Weight:**
1,200 g
- **Colour:**
Dark grey casing with red jaws
- **Output:**
 - D30N: two safety sockets (4 mm)
 - D30CN: two-wire 1.5 m cable with reinforced insulation or double insulation ending with 2 elbowed 4 mm male safety plugs

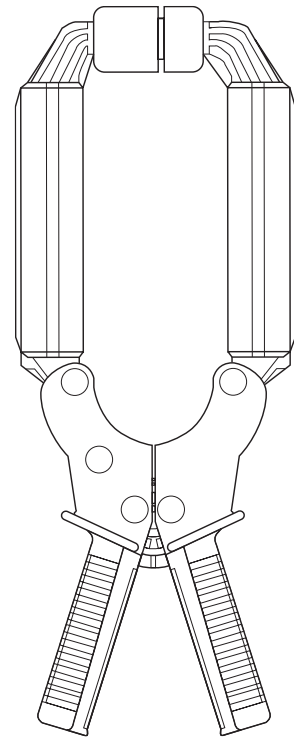

SAFETY SPECIFICATIONS

- **Electrical safety:**
Double insulation or reinforced insulation between the primary and the secondary circuits and the outside casing in accordance with IEC 1010-2-032.
 - 600 V category III, pollution degree 2
 - 300 V category IV, pollution degree 2
- **Electromagnetic compatibility (EMC):**
EN 50081-1: class B
EN 50082-2:
 - Electrical discharge: IEC 1000-4-2
 - Radiated field: IEC 1000-4-3
 - Fast transients: IEC 1000-4-4
 - Magnetic field at 50/60 Hz: IEC 1000-4-8

(1) Conditions of reference: 23 °C ± 5 °K, 20 % to 75 % RH, 48 Hz to 65 Hz, external magnetic field < 40 A/m, no DC component, no current-carrying conductor nearby, centred test sample, load impedance 5 Ω.

To order	Reference
AC current clamp model D30N with operating manual	P01120049A
AC current clamp model D30CN with operating manual	P01120064

Model D31N

Current	500 A AC	1,000 A AC	1,500 A AC
Ratio	500:1	1000:1	1500:1
Output	2 mA/A	1 mA/A	0.66 mA/A

ELECTRICAL SPECIFICATIONS

- Current range:**
1 A AC .. 500 A AC
1 A AC .. 1,000 A AC
1 A AC .. 1,500 A AC
- Current transformation ratio:**
500:1, 1000:1, 1500:1
- Output signal:**
2 mA/A AC (1 A to 500 A)
1 mA/A AC (1 A to 1,000 A)
0.66 mA/A AC (1 A to 1,500 A)
- Accuracy and phase shift (1):**

- 500 A calibre

Primary current	25 A	100 A	500 A
% Accuracy of output signal	4%	3%	3%
Phase shift	4°	3.5°	2°

- Load impedance: 5 Ω
- Overload: 700 A for 10 minutes
- Ampere second product: 6 A.s
- Accuracy: in accordance with IEC 185-26-27, 5 VA, class 3 from 48 Hz to 1,000 Hz

- 1,000 A calibre

Primary current	50 A	200 A	1,000 A
% Accuracy of output signal	3%	1.5%	1%
Phase shift	3°	1.5°	1°

- Load impedance: 5 Ω
- Overload: 1,400 A for 10 minutes
- Ampere second product: 30 A.s
- Accuracy: in accordance with IEC 185-26-27, 5 VA, class 1 from 48 Hz to 1,000 Hz

- 1,500 A calibre

Primary current	75 A	300 A	1,500 A
% Accuracy of output signal	1.5%	0.75%	0.5%
Phase shift	1.5°	0.75°	0.5°

- Load impedance: 5 Ω
- Overload: 1800 A for 10 minutes
- Ampere second product: 65 A.s
- Accuracy: in accordance with IEC 185-26-27, 5 VA class 0.5 from 48 Hz to 1,000 Hz

- **Bandwidth:**
30 Hz to 1,500 Hz (in continuous use above 1 kHz the max. measurement current is limited)

- **Load impedance:**
< 5 Ω
- **Operating voltage:**
600 V AC
- **Common mode voltage:**
600 V AC
- **Maximum output voltage (secondary open):**
Electronic protection circuit limiting voltage to 42 V peak max
- **Influence of adjacent conductor:**
0.005 A/A AC
- **Influence of conductor position in jaws:**
1.5% ± 0.2 A on the 500:1 ratio
1% ± 0.2 A on the 1000:1 ratio
1% ± 0.2 A on the 1500:1 ratio

MECHANICAL SPECIFICATIONS

- **Operating temperature:**
-10 °C to +50 °C
- **Storage temperature:**
-25 °C to +80 °C
- **Influence of temperature:**
< 0.1% per 10 °K
- **Max. jaw opening:**
90 mm
- **Max. jaw insertion capacity:**
Cable: 64 mm
Group of wires: 50 x 135 mm - 64 x 100 mm
- **Casing protection rating:**
IP20 in accordance with IEC 529
- **Drop test:**
500 mm (IEC 68-2-32)
- **Shock resistance:**
100 g, in accordance with IEC 68-2-27
- **Vibration resistance:**
10/55/10 Hz, 0.15 mm test in accordance with IEC 68-2-6
- **Self-extinguishing capability:**
Casing: UL94 V0
Jaws: UL94 V2
- **Dimensions:**
120 x 315 x 48 mm
- **Weight:**
1,200 g
- **Colour:**
Dark grey casing with red jaws
- **Output:**
2 Safety sockets (4 mm)

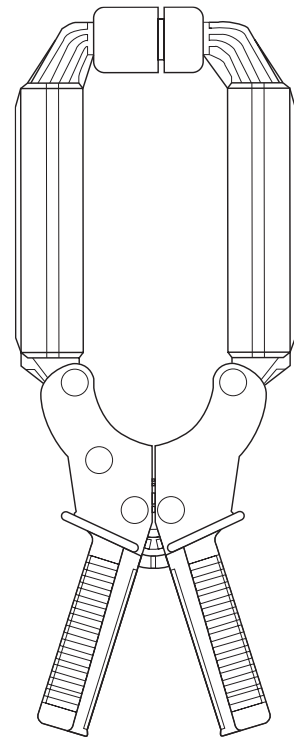

SAFETY SPECIFICATIONS

- **Electrical safety:**
Double insulation or reinforced insulation between the primary and the secondary circuits and the outside casing in accordance with IEC 1010-2-032.
- 600 V category III, pollution degree 2
- 300 V category IV, pollution degree 2
- **Electromagnetic compatibility (EMC):**
EN 50081-1: class B
EN 50082-2:
- Electrical discharge: IEC 1000-4-2
- Radiated field: IEC 1000-4-3
- Fast transients: IEC 1000-4-4
- Magnetic field at 50/60 Hz: IEC 1000-4-8

(1) Conditions of reference: 23 °C ± 5 °K, 20% to 75% RH, 48 Hz to 65 Hz, external magnetic field < 40 A/m, no DC component, no current-carrying conductor nearby, centred test sample.

To order	Reference
AC current clamp model D31N with operating manual	P01120050A

Current clamp for AC current

Model D32N

DN series

Current	1,000 A AC	2,000 A AC	2,400 A AC
Ratio	1000:1	2000:1	3000:1
Output	1 mA/A	0.5 mA/A	0.333 mA/A

ELECTRICAL SPECIFICATIONS

- Current range:**
 - 1 A AC .. 1,000 A AC
 - 1 A AC .. 2,000 A AC
 - 1 A AC .. 2,400 A AC
- Current transformation ratio:**
 - 1000:1, 2000:1, 3000:1
- Output signal:**
 - 1 mA/A AC (1 A to 1,000 A)
 - 0.5 mA/A AC (1 A to 2,000 A)
 - 0.333 mA/A AC (1 A to 3,000 A)

- Accuracy and phase shift (1):**

- 1,000 A calibre

Primary current	50 A	200 A	1,000 A
% Accuracy of output signal	3 %	1.5 %	1 %
Phase shift	3°	1.5°	1°

- Load impedance: 2.5 Ω
- Overload: 1,400 A for 10 minutes
- Ampere second product: 25 A.s
- Accuracy: in accordance with IEC 185-26-27, 2.5 VA, class 1 from 48 Hz to 1,000 Hz

- 2,000 A calibre

Primary current	100 A	400 A	2,000 A
% Accuracy of output signal	1.5 %	0.75 %	0.5 %
Phase shift	1.5°	0.75°	0.5°

- Load impedance: 5 Ω
- Overload: 2,400 A for 10 minutes
- Ampere second product: 60 A.s
- Accuracy: in accordance with IEC 185-26-27, 5 VA, class 0.5 from 48 Hz to 1,000 Hz

- 3,000 A calibre

Primary current	150 A	600 A	3,000 A
% Accuracy of output signal	1.5 %	0.75 %	0.5 %
Phase shift	1.5°	0.75°	0.5°

- Load impedance: 10 Ω
- Overload: 3,400 A for 10 minutes
- Ampere second product: 90 A.s
- Accuracy: in accordance with IEC 185-26-27, 10 VA class 0.5 from 48 Hz to 1,000 Hz

- **Bandwidth:**
 - 30 Hz to 1,000 Hz (in continuous use above 600 Hz the max. measurement current is limited)
- **Load impedance:**
 - < 10 Ω max
- **Operating voltage:**
 - 600 V AC
- **Common mode voltage:**
 - 600 V AC
- **Maximum output voltage (secondary open):**
 - Electronic protection circuit limiting voltage to 42 V peak max
- **Influence of adjacent conductor:**
 - 0.005 A/A AC
- **Influence of conductor position in jaws:**
 - 1.5 % ± 0.2 A on the 1000:1 ratio
 - 1 % ± 0.2 A on the 2000:1 ratio
 - 1 % ± 0.2 A on the 3000:1 ratio

MECHANICAL SPECIFICATIONS

- **Operating temperature:**
 - 10 °C to +50 °C
- **Storage temperature:**
 - 25 °C to +80 °C
- **Influence of temperature:**
 - < 0.1 % per 10 °K
- **Max. jaw opening:**
 - 90 mm
- **Max. jaw insertion capacity:**
 - Cable: 64 mm
 - Group of wires: 50 x 135 mm - 64 x 100 mm
- **Casing protection rating:**
 - IP20 in accordance with IEC 529
- **Drop test:**
 - 500 mm (IEC 68-2-32)
- **Shock resistance:**
 - 100 g, in accordance with IEC 68-2-27
- **Vibration resistance:**
 - 10/55/10 Hz, 0.15 mm
 - test in accordance with IEC 68-2-6
- **Self-extinguishing capability:**
 - Casing: UL94 V0
 - Jaws: UL94 V2
- **Dimensions:**
 - 120 x 315 x 48 mm

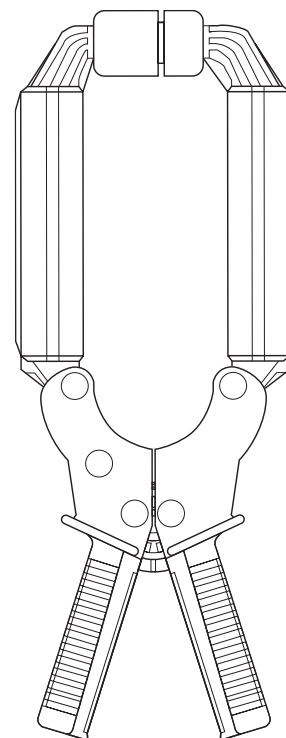

- **Weight:**
 - 1,200 g
- **Colour:**
 - Dark grey casing with red jaws
- **Output:**
 - 2 Safety sockets (4 mm)

SAFETY SPECIFICATIONS

- **Electrical safety:**
 - Double insulation or reinforced insulation between the primary and the secondary circuits and the outside casing in accordance with IEC 1010-2-032.
 - 600 V category III, pollution degree 2
 - 300 V category IV, pollution degree 2
- **Electromagnetic compatibility (EMC):**
 - EN 50081-1: class B
 - EN 50082-2:
 - Electrical discharge: IEC 1000-4-2
 - Radiated field: IEC 1000-4-3
 - Fast transients: IEC 1000-4-4
 - Magnetic field at 50/60 Hz: IEC 1000-4-8

(1) Conditions of reference: 23 °C ± 5 °K, 20 % to 75 % RH, 48 Hz to 65 Hz, external magnetic field < 40 A/m, no DC component, no current-carrying conductor nearby, centred test sample.

To order	Reference
AC current clamp model D32N with operating manual	P01120051A

Current clamp for AC current

Model D33N

D_N series

Current	2,400 A AC
Ratio	3000:5
Output	1.666 mA/A

ELECTRICAL SPECIFICATIONS

- **Current range:**
1 A AC .. 2,400 A AC
(3,000 A for temperature < 35 °C)
- **Current transformation ratio:**
3000:5
- **Output signal:**
1.666 mA/A AC (5 A for 3,000 A)
- **Accuracy and phase shift ⁽¹⁾:**

Primary current	150 A	600 A	3,000 A
Accuracy in % of output signal	3 %	1.5 %	1 %
Phase shift	3°	1.5°	1°

- **Overload:**
3600 A for 10 minutes
- **Accuracy:**
In accordance with IEC 185-26-27, 5 VA class 1 from 48 Hz to 1,000 Hz
- **Bandwidth:**
30 Hz to 5 kHz (in continuous use above 1 kHz, the max. measurement current is limited)
- **Ampere second product:**
90 A.s
- **Load impedance:**
< 1 Ω
- **Operating voltage:**
600 V AC
- **Common mode voltage:**
600 V AC
- **Influence of adjacent conductor:**
0.005 A/A AC
- **Influence of conductor position in jaws:**
1 % ± 0.1 A

MECHANICAL SPECIFICATIONS

- **Operating temperature:**
-10 °C to +50 °C
- **Storage temperature:**
-25 °C to +80 °C
- **Influence of temperature:**
< 0.1 % per 10 °K
- **Max. jaw opening:**
90 mm
- **Max. jaw insertion capacity:**
Cable: 64 mm
Group of wires: 50 x 135 mm - 64 x 100 mm
- **Casing protection rating:**
IP20 in accordance with IEC 529
- **Drop test:**
500 mm (IEC 68-2-32)
- **Shock resistance:**
100 g, in accordance with IEC 68-2-27
- **Vibration resistance:**
10/55/10 Hz, 0.15 mm
test in accordance with IEC 68-2-6
- **Self-extinguishing capability:**
Casing: UL94 V0
Jaws: UL94 V2
- **Dimensions:**
120 x 315 x 48 mm
- **Weight:** 1,200 g
- **Colour:**
Dark grey casing with red jaws
- **Output:**
2 Safety sockets (4 mm)

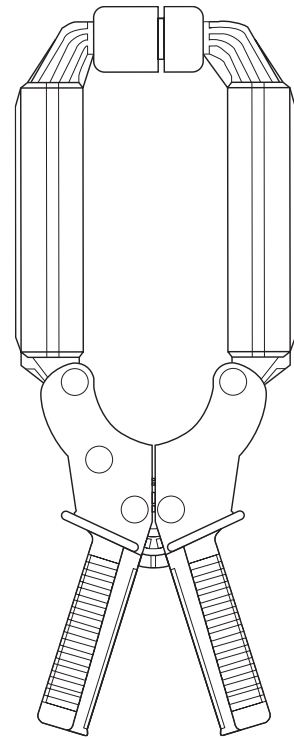

SAFETY SPECIFICATIONS

- **Electrical safety:**
Double insulation or reinforced insulation between the primary and the secondary circuits and the outside casing in accordance with IEC 1010-2-032.
- 600 V category III, pollution degree 2
- 300 V category IV, pollution degree 2
- **Electromagnetic compatibility (EMC):**
EN 50081-1: class B
EN 50082-2:
- Electrical discharge: IEC 1000-4-2
- Radiated field: IEC 1000-4-3
- Fast transients: IEC 1000-4-4
- Magnetic field at 50/60 Hz: IEC 1000-4-8

(1) Conditions of reference: 23 °C ± 5 °K, 20 % to 75 % RH, 48 Hz to 65 Hz, external magnetic field < 40 A/m, no DC component, no current-carrying conductor nearby, centred test sample, load impedance 0.2 Ω.

To order	Reference
AC current clamp model D33N with operating manual	P01120052A

Current clamp for AC current

Model D34N

D_N series

Current	500 A AC	1,000 A AC	1,500 A AC
Ratio	500:5	1000:5	1500:5
Output	10 mA/A	5 mA/A	3.33 mA/A

ELECTRICAL SPECIFICATIONS

- Current range:**
 - 1 A AC .. 500 A AC
 - 1 A AC .. 1,000 A AC
 - 1 A AC .. 1,500 A AC
- Current transformation ratio:**
 - 500:5, 1000:5, 1500:5
- Output signal:**
 - 10 mA/A AC (5 A for 500 A)
 - 5 mA/A AC (5 A for 1,000 A)
 - 3.33 mA/A AC (5 A for 1,500 A)
- Accuracy and phase shift⁽¹⁾:**

■ 500 A calibre

Primary current	25 A	100 A	500 A
Accuracy in % of output signal	5 %	3 %	3 %
Phase shift	6°	4°	4°

- Load impedance: 0.2 Ω
- Overload: 700 A for 10 minutes
- Ampere second product: 3.5 A.s
- Accuracy: in accordance with IEC 185-26-27, 5 VA class 3 from 48 Hz to 1,000 Hz

■ 1,000 A calibre

Primary current	50 A	200 A	1,000 A
Accuracy in % of output signal	3 %	1.5 %	1 %
Phase shift	3°	1.5°	1°

- Load impedance: 0.1 Ω
- Overload: 1,400 A for 10 minutes
- Ampere second product: 18 A.s
- Accuracy: in accordance with IEC 185-26-27, 2.5 VA class 1 from 48 Hz to 1,000 Hz

■ 1,500 A calibre

Primary current	75 A	300 A	1,500 A
Accuracy in % of output signal	1.5 %	0.75 %	0.5 %
Phase shift	1.5°	0.75°	0.5°

- Load impedance: 0.1 Ω
- Overload: 1800 A for 10 minutes
- Ampere second product: 40 A.s
- Accuracy: in accordance with IEC 185-26-27, 2.5 VA class 0.5 from 48 Hz to 1,000 Hz

- Bandwidth:**
 - 30 Hz to 1,500 Hz (in continuous use above 1.5 kHz the max. measurement current is limited)
- Load impedance:**
 - < 1 Ω max
- Operating voltage:**
 - 600 V AC
- Common mode voltage:**
 - 600 V AC
- Maximum output voltage (secondary open):**
 - Electronic protection limiting the voltage to 42 V peak max.
- Influence of adjacent conductor:**
 - 0.005 A/A AC
- Influence of conductor position in jaws:**
 - 1.5 % ± 0.2 A on the 500:5 ratio
 - 1 % ± 0.2 A on the 1000:5 ratio
 - 1 % ± 0.2 A on the 1500:5 ratio

MECHANICAL SPECIFICATIONS

- Operating temperature:**
 - 10 °C to +50 °C
- Storage temperature:**
 - 25 °C to +80 °C
- Influence of temperature:**
 - < 0.1 % per 10 °K
- Max. jaw opening:**
 - 90 mm
- Max. jaw insertion capacity:**
 - Cable: 64 mm
 - Group of wires: 50 x 135 mm - 64 x 100 mm
- Casing protection rating:**
 - IP20 in accordance with IEC 529
- Drop test:**
 - 500 mm (IEC 68-2-32)
- Shock resistance:**
 - 100 g, in accordance with IEC 68-2-27
- Vibration resistance:**
 - 10/55/10 Hz, 0.15 mm
 - test in accordance with IEC 68-2-6
- Self-extinguishing capability:**
 - Casing: UL94 V0
 - Jaws: UL94 V2

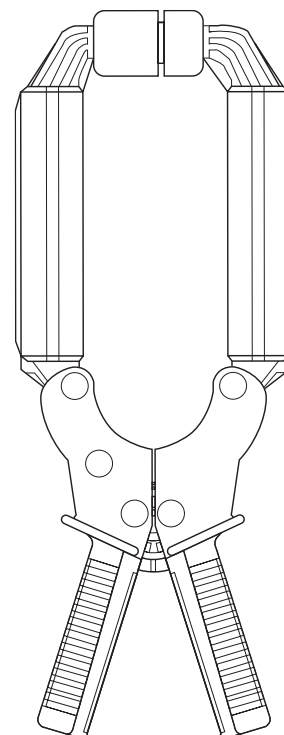

- Dimensions:**
 - 120 x 315 x 48 mm
- Weight:**
 - 1,200 g
- Colour:**
 - Dark grey casing with red jaws
- Output:**
 - 2 Safety sockets (4 mm)

SAFETY SPECIFICATIONS

- Electrical safety:**
 - Double insulation or reinforced insulation between the primary and the secondary circuits and the outside casing in accordance with IEC 1010-2-032.
 - 600 V category III, pollution degree 2
 - 300 V category IV, pollution degree 2
- Electromagnetic compatibility (EMC):**
 - EN 50081-1: class B
 - EN 50082-2:
 - Electrical discharge: IEC 1000-4-2
 - Radiated field: IEC 1000-4-3
 - Fast transients: IEC 1000-4-4
 - Magnetic field at 50/60 Hz: IEC 1000-4-8

(1) Conditions of reference: 23 °C ± 5 °K, 20 % to 75 % RH, 48 Hz to 65 Hz, external magnetic field < 40 A/m, no DC component, no current-carrying conductor nearby, centred test sample.

To order	Reference
AC current clamp model D34N with operating manual	P01120053A

Model D35N

Current	1,000 A AC	2,000 A AC	2,400 A AC
Ratio	1000:5	2000:5	3000:5
Output	5 mA/A	2.5 mA/A	1.666 mA/A

ELECTRICAL SPECIFICATIONS

- Current range:**
 - 1 A AC .. 1,000 A AC
 - 1 A AC .. 2,000 A AC
 - 1 A AC .. 2,400 A AC
 - (3,000 A for temperature < 35 °C)
- Current transformation ratio:**
 - 1000:5, 2000:5, 3000:5
- Output signal:**
 - 5 mA/A AC (5 A for 1,000 A)
 - 2.5 mA/A AC (5 A for 2,000 A)
 - 1.666 mA/A AC (5 A for 3,000 A)
- Accuracy and phase shift ⁽¹⁾:**

■ 1,000 A calibre

Primary current	50 A	200 A	1,000 A
% Accuracy of output signal	3 %	1.5 %	1 %
Phase shift	3°	1.5°	1°

- Load impedance: 0.1 Ω
- Overload: 1,200 A for 10 minutes
- Ampere second product: 15 A.s
- Accuracy: in accordance with IEC 185-26-27, 2.5 VA, class 1 from 48 Hz to 1,000 Hz

■ 2,000 A calibre

Primary current	100 A	400 A	2,000 A
% Accuracy of output signal	1.5 %	0.75 %	0.5 %
Phase shift	1.5°	0.75°	0.5°

- Load impedance: 0.2 Ω
- Overload: 2,400 A for 10 minutes
- Ampere second product: 50 A.s
- Accuracy: in accordance with IEC 185-26-27, 5 VA, class 0.5 from 48 Hz to 1,000 Hz

■ 3,000 A calibre

Primary current	150 A	600 A	3,000 A
% Accuracy of output signal	1.5 %	0.75 %	0.5 %
Phase shift	1.5°	0.75°	0.5°

- Load impedance: 0.4 Ω
- Overload: 2,400 A for 10 minutes
- Ampere second product: 80 A.s
- Accuracy: in accordance with IEC 185-26-27, 10 VA class 0.5 from 48 Hz to 1,000 Hz

- Bandwidth:**
 - 30 Hz to 1,500 Hz (in continuous use above 1.5 kHz, the max. measurement current is limited)
- Load impedance:**
 - < 2 Ω max
- Operating voltage:**
 - 600 V AC
- Common mode voltage:**
 - 600 V AC
- Influence of adjacent conductor:**
 - 0.005 A/A AC
- Influence of conductor position in jaws:**
 - 1.5 % ± 0.2 A on the 1000:5 ratio
 - 1 % ± 0.2 A on the 2000:5 ratio
 - 1 % ± 0.2 A on the 3000:5 ratio

MECHANICAL SPECIFICATIONS

- Operating temperature:**
 - 10 °C to +50 °C
- Storage temperature:**
 - 25 °C to +80 °C
- Influence of temperature:**
 - < 0.1 % per 10 °K
- Max. jaw opening:**
 - 90 mm
- Max. jaw insertion capacity:**
 - Cable: 64 mm
 - Group of wires: 50 x 135 mm - 64 x 100 mm
- Casing protection rating:**
 - IP20 in accordance with IEC 529
- Drop test:**
 - 500 mm (IEC 68-2-32)
- Shock resistance:**
 - 100 g, in accordance with IEC 68-2-27
- Vibration resistance:**
 - 10/55/10 Hz, 0.15 mm
 - test in accordance with IEC 68-2-6
- Self-extinguishing capability:**
 - Casing: UL94 V0
 - Jaws: UL94 V2
- Dimensions:**
 - 120 x 315 x 48 mm
- Weight:**
 - 1,200 g

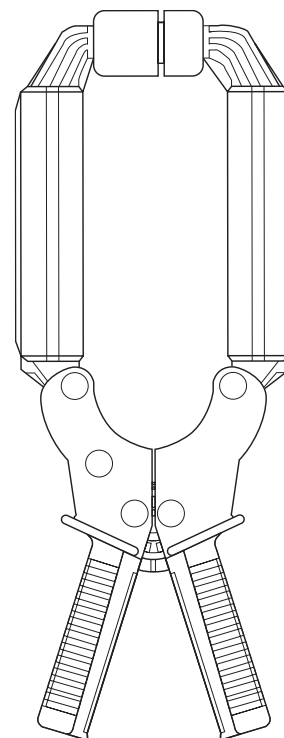

- Colour:**
 - Dark grey casing with red jaws
- Output:**
 - Safety sockets (4 mm)

SAFETY SPECIFICATIONS

- Electrical safety:**
 - Double insulation or reinforced insulation between the primary and the secondary circuits and the outside casing in accordance with IEC 1010-2-032.
 - 600 V category III, pollution degree 2
 - 300 V category IV, pollution degree 2
- Electromagnetic compatibility (EMC):**
 - EN 50081-1: class B
 - EN 50082-2:
 - Electrical discharge: IEC 1000-4-2
 - Radiated field: IEC 1000-4-3
 - Fast transients: IEC 1000-4-4
 - Magnetic field at 50/60 Hz: IEC 1000-4-8

(1) Conditions of reference: 23 °C ± 5 °K, 20 % to 75 % RH, 48 Hz to 65 Hz, external magnetic field < 40 A/m, no DC component, no current-carrying conductor nearby, centred test sample.

To order	Reference
AC current clamp model D35N with operating manual	P01120054A

Model D36N

Current	3,000 A AC
Ratio	3000:3
Output	1 mA/A

ELECTRICAL SPECIFICATIONS

- **Current range:**
1 A AC .. 2,400 A AC
- **Current transformation ratio:**
3000:3
- **Output signal:**
1 mA/A AC (3 A for 3,000 A)
- **Accuracy and phase shift (1):**

Primary current	150 A	600 A	3,000 A
% Accuracy of output signal	0.5 %	0.75 %	0.5 %
Phase shift	1.5°	0.75°	0.5°

- **Accuracy:**
In accordance with IEC 185-26-27, 5 VA, class 0.5 from 48 Hz to 1,000 Hz
- **Bandwidth:**
30 Hz to 5 kHz
(beyond 400 Hz the output is limited in inverse proportion to the frequency)
- **Overload:**
3600 A for 5 minutes
- **Maximum output voltage (secondary open):**
Electronic protection circuit limiting voltage to 42 V peak max
- **Load impedance:**
< 0.6 Ω
- **Operating voltage:**
600 V AC
- **Common mode voltage:**
600 V AC
- **Influence of adjacent conductor:**
0.005 A/A AC
- **Influence of conductor position in jaws:**
1 % ± 0.1 A

MECHANICAL SPECIFICATIONS

- **Operating temperature:**
-10 °C to +50 °C
- **Storage temperature:**
-25 °C to +80 °C
- **Influence of temperature:**
< 0.1 % per 10 °K
- **Max. jaw opening:**
90 mm
- **Max. jaw insertion capacity:**
Cable: 64 mm
Group of wires: 50 x 135 mm - 64 x 100 mm
- **Casing protection rating:**
IP20 in accordance with IEC 529
- **Drop test:**
500 mm (IEC 68-2-32)
- **Shock resistance:**
100 g, in accordance with IEC 68-2-27
- **Vibration resistance:**
10/55/10 Hz, 0.15 mm
test in accordance with IEC 68-2-6
- **Self-extinguishing capability:**
Casing: UL94 V0
Jaws: UL94 V2
- **Dimensions:**
120 x 315 x 48 mm
- **Weight:**
1,200 g
- **Colour:**
Dark grey casing with red jaws
- **Output:**
Safety jacks (4 mm)

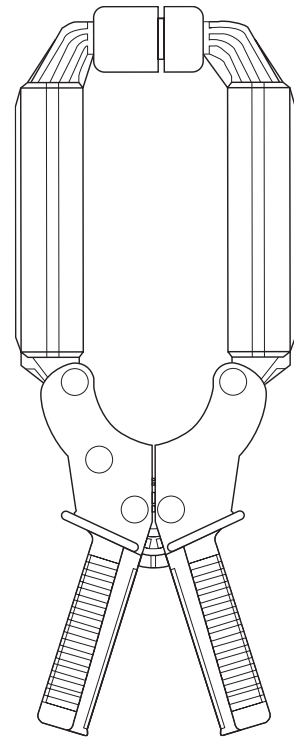

SAFETY SPECIFICATIONS

- **Electrical safety:**
Double insulation or reinforced insulation between the primary and the secondary circuits and the outside casing in accordance with IEC 1010-2-032.
- 600 V category III, pollution degree 2
- 300 V category IV, pollution degree 2
- **Electromagnetic compatibility (EMC):**
EN 50081-1: class B
EN 50082-2:
- Electrical discharge: IEC 1000-4-2
- Radiated field: IEC 1000-4-3
- Fast transients: IEC 1000-4-4
- Magnetic field at 50/60 Hz: IEC 1000-4-8

(1) Conditions of reference: 23 °C ± 5 °K, 20 % to 75 % RH, 48 Hz to 65 Hz, external magnetic field < 40 A/m, no DC component, no current-carrying conductor nearby, centred test sample, load impedance 0.55 Ω.

To order	Reference
AC current clamp model D36N with operating manual	P01120055A

Current clamp for AC current

Model D37N

DN series

Current	30 A AC	300 A AC	3,000 A AC
Output	100 mV/A	10 mV/A	1 mV/A

ELECTRICAL SPECIFICATIONS

- Current range:**
10 mA .. 30 A AC
1 A AC .. 300 A AC
1 A AC .. 2,000 A AC
(2,800 A for temperature < 35 °C)
- Output signal:**
100 mV/A AC (3 V for 30 A) 90 A peak
10 mV/A AC (3 V for 300 A) 900 A peak
1.666 mV/A AC (3 V for 3,000 A) 9,000 A peak

- Accuracy and phase shift (1):**

- 30 A calibre

Primary current	1.5 A	6 A	30 A
% Accuracy of output signal	2% ± 10 mV		
Phase shift	15°	7°	5°

- 300 A calibre

Primary current	15 A	60 A	300 A
% Accuracy of output signal	2% ± 2 mV		
Phase shift	3°	1.5°	1°

- 3,000 A calibre

Primary current	150 A	600 A	3,000 A
% Accuracy of output signal	2% ± 0.5 mV		
Phase shift	1.5°	1°	0.5°

- Overload:**
3,200 A for 5 minutes
- Ampere second product:**
100 A.s
- dV/dt:**
100 mVAC/A AC: dV/dt = 400 mV/μs
10 mVAC/A AC: dV/dt = 50 mV/μs
1 mVAC/A AC: dV/dt = 5 mV/μs
- Bandwidth:**
30 Hz to 5 kHz (on the 3,000 A range the max. measurement current is limited above 200 Hz)
- Load impedance:**
≥ 1 MΩ
- Operating voltage:**
600 VAC

- Common mode voltage:**
600 VAC
- Influence of adjacent conductor:**
0.005 A/A AC
- Influence of conductor position in jaws:**
1.5% of the reading
- Influence of frequency:**
of 30 Hz to 5 kHz: ± 6% on all calibres
- Influence of DC current:**
0.04% per A DC

MECHANICAL SPECIFICATIONS

- Operating temperature:**
-10 °C to +50 °C
- Storage temperature:**
-25 °C to +80 °C
- Influence of temperature:**
< 0.1% per 10°K
- Max. jaw opening:**
90 mm
- Max. jaw insertion capacity:**
Cable: 64 mm
Group of wires: 50 x 135 mm - 64 x 100 mm
- Casing protection rating:**
IP20 in accordance with IEC 529
- Drop test:**
500 mm (IEC 68-2-32)
- Shock resistance:**
100 g, in accordance with IEC 68-2-27
- Vibration resistance:**
10/55/10 Hz, 0.15 mm
test in accordance with IEC 68-2-6
- Self-extinguishing capability:**
Casing: UL94 V0
Jaws: UL94 V2
- Dimensions:**
120 x 315 x 48 mm
- Weight:**
1,200 g
- Colour:**
Dark grey casing with red jaws
- Output:**
Safety jacks (4 mm)

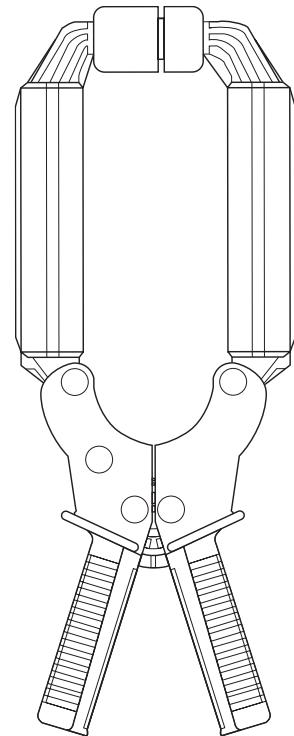

SAFETY SPECIFICATIONS

- Electrical safety:**
Double insulation or reinforced insulation between the primary and the secondary circuits and the outside casing in accordance with IEC 1010-2-032.
- 600 V category III, pollution degree 2
- 300 V category IV, pollution degree 2
- Electromagnetic compatibility (EMC):**
EN 50081-1: class B
EN 50082-2:
- Electrical discharge: IEC 1000-4-2
- Radiated field: IEC 1000-4-3
- Fast transients: IEC 1000-4-4
- Magnetic field at 50/60 Hz: IEC 1000-4-8

(1) Conditions of reference: 23 °C ± 5 °K, 20% to 75% RH, 48 Hz to 65 Hz, external magnetic field < 40 A/m, no DC component, no current-carrying conductor nearby, centred test sample.

To order	Reference
AC current clamp model D37N with operating manual	P01120056A

Model D38N (insulated AC current probe)

Current	90 A peak	900 A peak	9,000 A peak
Output	10 mV/A	1 mV/A	0.1 mV/A

DESCRIPTION

The D38N offers accurate AC current measurement and a voltage output in mV allowing direct readings on oscilloscopes. A switch with 3 positions on the handle can be used to select the ranges. The wide opening of the jaws means they can be used on cables and small busbars.

ELECTRICAL SPECIFICATIONS

Current calibres:

- 1 A AC .. 30 A AC (90 A peak)
- 1 A AC .. 300 A AC (900 A peak)
- 1 A AC .. 2,400 A AC (9,000 A peak)
(3,000 A for temperature < 35 °C)

Output signal:

- 10 mV/A AC (3 V for 30 A)
- 1 mV/A AC (3 V for 300 A)
- 0.1 mV/A AC (3 V for 3,000 A)

Accuracy and phase shift ⁽¹⁾:

■ 30 A calibre

Primary current	1.5 A	6 A	30 A	36 A
% Accuracy of output signal	2% ± 1 mV			
Phase shift	≤ 20°	≤ 10°	≤ 5°	≤ 5°

■ 300 A calibre

Primary current	15 A	60 A	300 A	360 A
% Accuracy of output signal	2% ± 0.5 mV			
Phase shift	≤ 3°	≤ 1.5°	≤ 1°	≤ 1°

■ 3,000 A calibre

Primary current	150 A	600 A	3,000 A	3600 A
% Accuracy of output signal	2% ± 0.2 mV			
Phase shift	≤ 3°	≤ 1.5°	≤ 1°	≤ 1°

Bandwidth:

10 Hz to 50 kHz (depending on current)

Rise/fall time from 10 % to 90 %:

4 μs

10 % delay time:

0.3 μs

Ampere second product:

- 30 A calibre: 30 A.s
- 300 A calibre: 125 A.s
- 3,000 A calibre: 180 A.s

Insertion impedance (at 400 Hz / 10 kHz):

- 30 A calibre: < 0.1 mΩ / < 1 mΩ
- 300 A calibre: < 0.1 mΩ / < 0.5 mΩ
- 3,000 A calibre: < 0.1 mΩ / < 0.4 mΩ

Maximum currents:

- 1 < 2,400 A permanent
- 2,400 A .. 2,800 A for 10 minutes and then 30 minutes shutdown
- 2,800 A .. 4,000 A for 5 minutes and then 30 minutes shutdown

Output impedance:

- 30 A calibre: ≤ 130 Ω ± 15 %
- 300 A calibre: ≤ 140 Ω ± 15 %
- 3,000 A calibre: ≤ 140 Ω ± 15 %

Influence of temperature:

- ≤ 0.2 % of output signal par 10 K

Influence of adjacent conductor:

- ≤ 5 mA/A at 50 Hz

Influence of DC current < 10 % of rated calibre superimposed on the rated current:

- 0.05 % / A DC

Influence of conductor position in jaws:

- ≤ 1 % + 0.1 A at 50/60 Hz

Influence of frequency ⁽²⁾:

- 30 A calibre: < 1 dB from 10 Hz .. 10 kHz
- 300 A calibre: < 1 dB from 10 Hz .. 10 kHz
- 3,000 A calibre: < 1 dB from 10 Hz .. 10 kHz

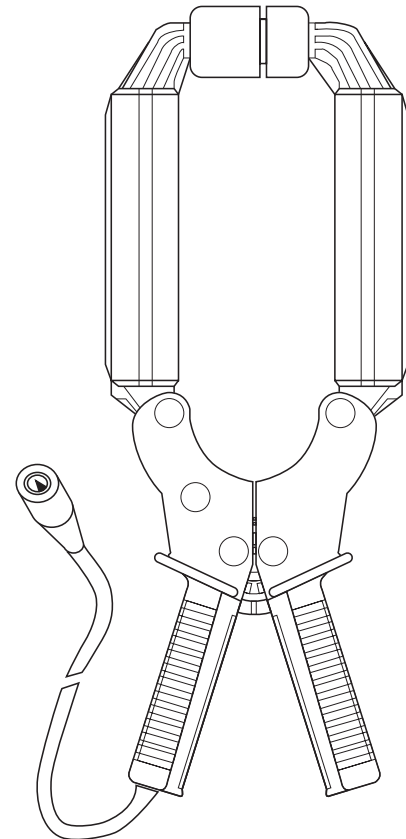

MECHANICAL SPECIFICATIONS

Max. jaw opening:

90 mm

Clamping capacity:

Cable: Ø max 64 mm

Busbars:

- 5 busbars from 125 x 5 mm
- 3 busbars from 100 x 10 mm
(busbars spaced by their thickness)

Output:

Via 2 m coaxial cable terminated by insulated BNC plug

Dimensions:

310 x 120 x 48 mm

Weight:

1,200 g

Operating temperature:

-10 °C to +50 °C

Storage temperature:

-25 °C to +80 °C

Relative humidity for operation:

0 to 85 % RH with a linear decrease above 35 °C

Operating altitude:

0 to 2,000 m

Casing protection rating:

IP 20 (IEC 529)

Drop test:

0.5 m (IEC 68-2-32)

Shock resistance:

100 g / 6 ms / half-period (IEC 68-2-27)

Protection against impacts:

IK04 0.5 J (EN 50102)

Vibration resistance:

10/55/10 Hz, 0.15 mm (IEC 68-2-6)

Self-extinguishing capability:

Handles: UL94 V0
Jaws: UL94 V2

Colours:

Dark grey handles with red jaws

SAFETY SPECIFICATIONS

Electrical safety:

- Instrument with double insulation or reinforced insulation between the primary the secondary and the grippable part located under the guard as per IEC 1010-1 & IEC 1010-2-032
- 600 V category III, pollution degree 2
- 300 V category IV, pollution degree 2

Oscilloscope clamp for AC current

Model D38N (insulated AC current probe)

D_N series



CURVES AT 50 Hz

30 A calibre

Error on measurement

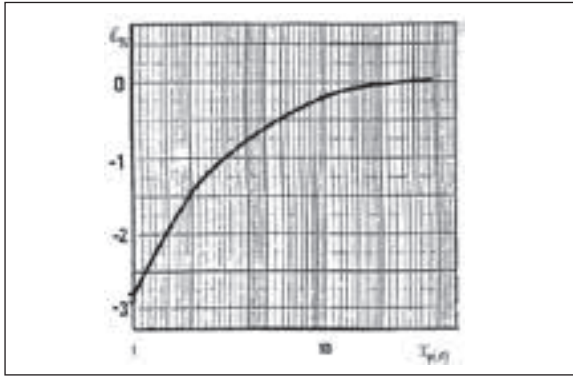

Phase shift

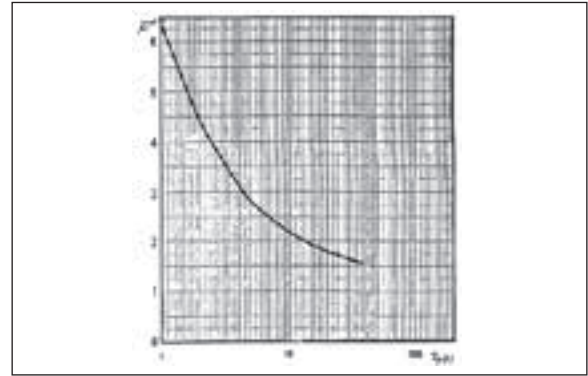

300 A calibre

Error on measurement

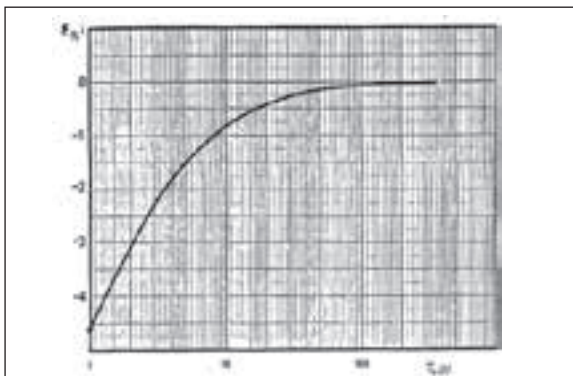

Phase shift

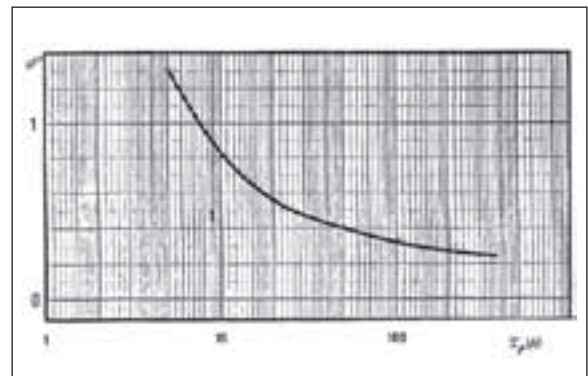

3,000 A calibre

Error on measurement

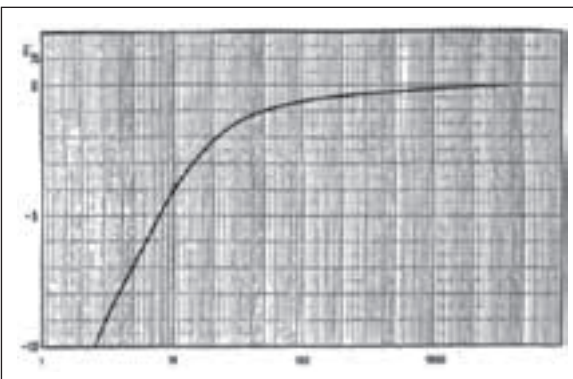

Phase shift

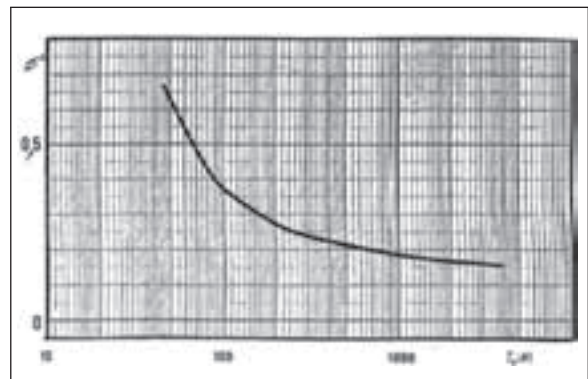

Oscilloscope clamp for AC current

Model D38N (insulated AC current probe)

D_N series



FREQUENCY RESPONSE

30 A calibre

I = 10 A

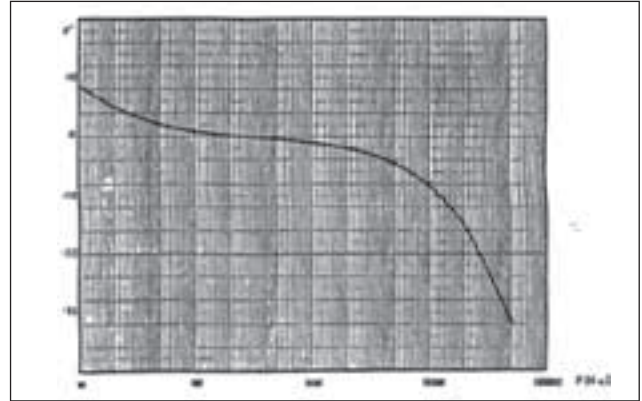
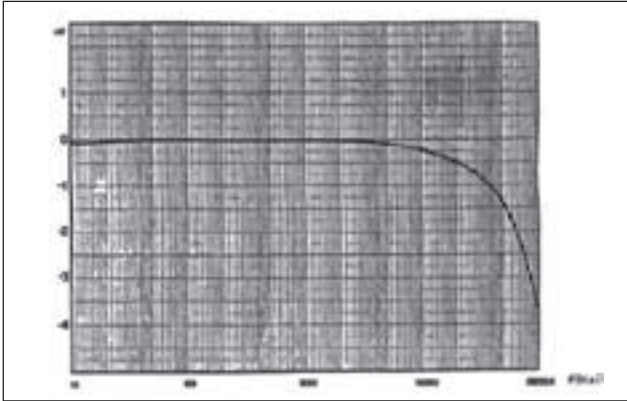

300 A calibre

I = 10 A

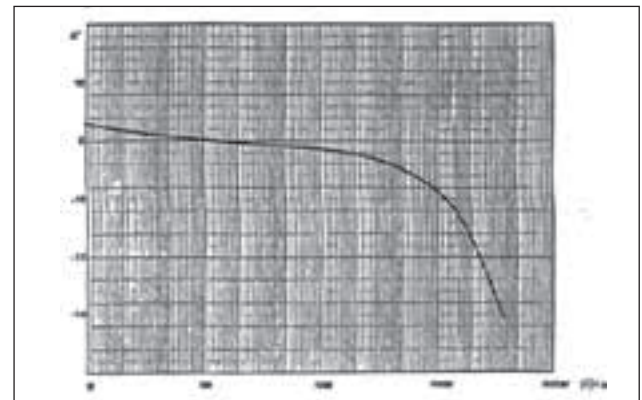
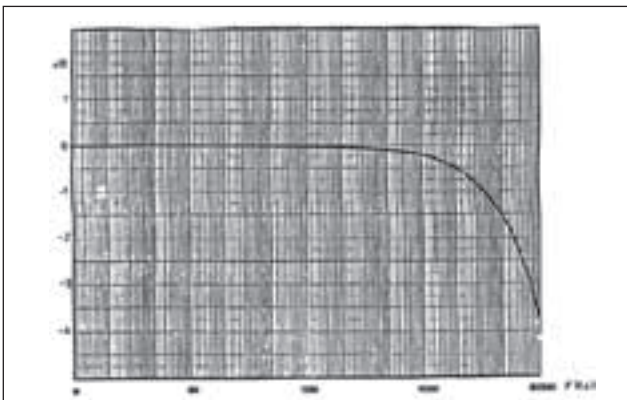

3,000 A calibre

I = 100 A

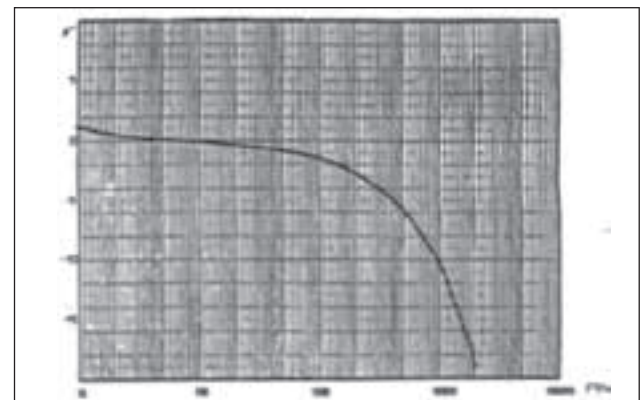
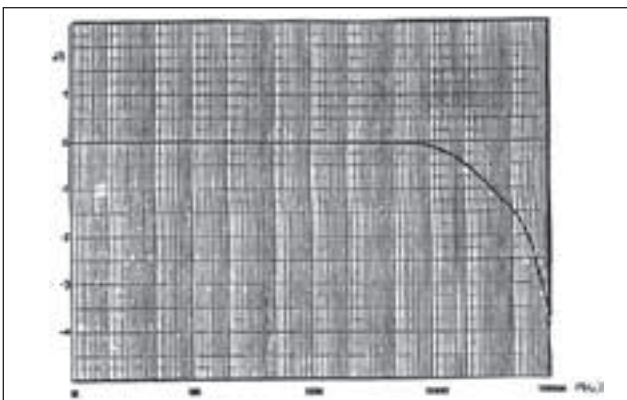

Oscilloscope clamp for AC current

Model D38N (insulated AC current probe)

D_N series



RESPONSE TO A SQUARE SIGNAL ($I_p = 1$ A)

30 A calibre

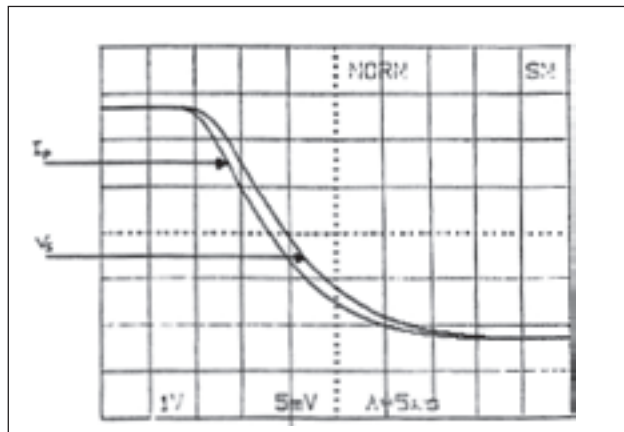
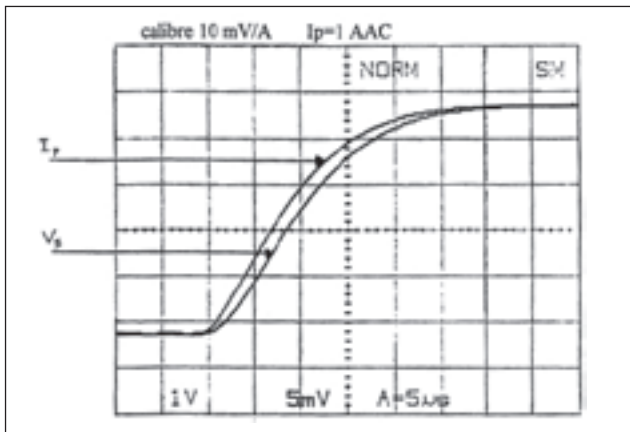

RESPONSE TO A SQUARE SIGNAL ($I_p = 10$ A)

30 A calibre

10 Hz

100 Hz

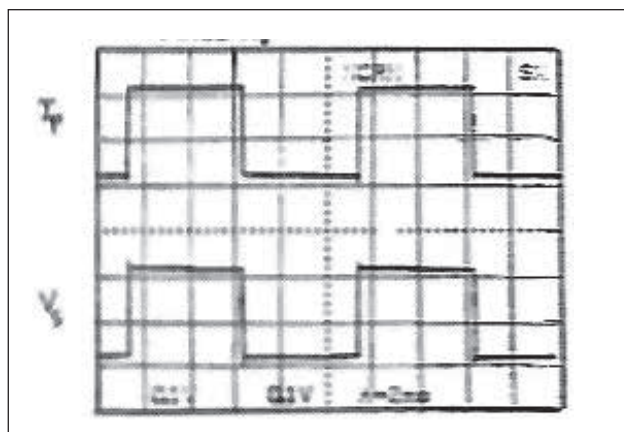
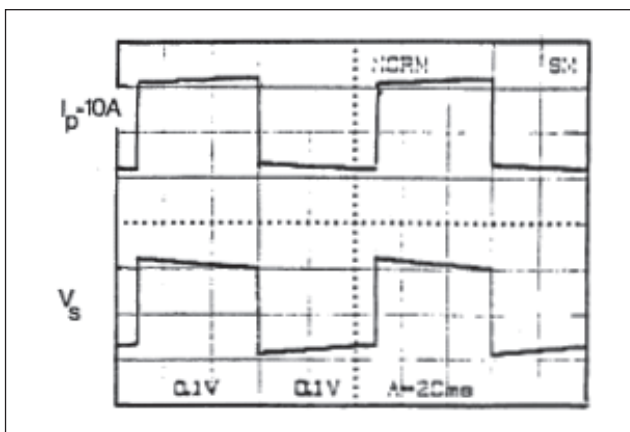

1 kHz

10 kHz

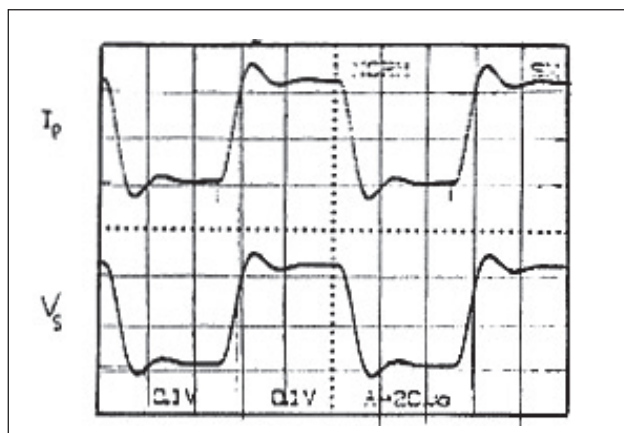
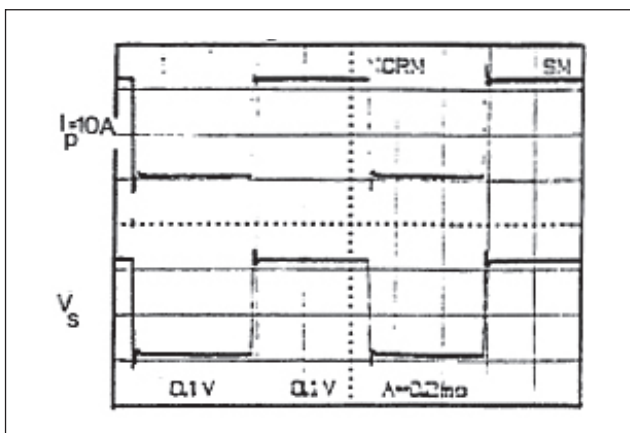

Oscilloscope clamp for AC current

D_N series

Model D38N (insulated AC current probe)

INFLUENCE OF DC CURRENT SUPERIMPOSED ON THE SIGNAL

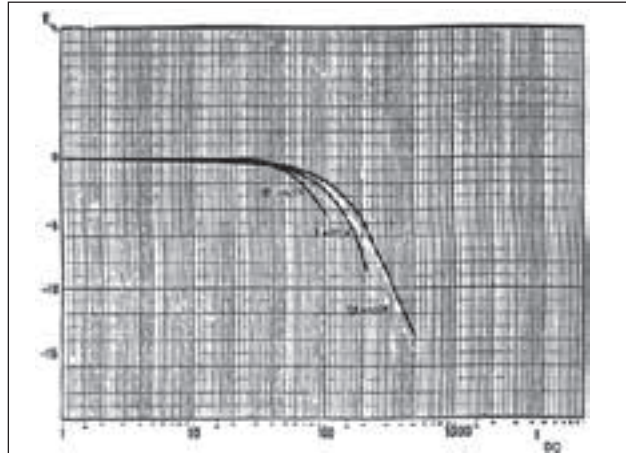

MAXIMUM CURRENT ACCORDING TO FREQUENCY

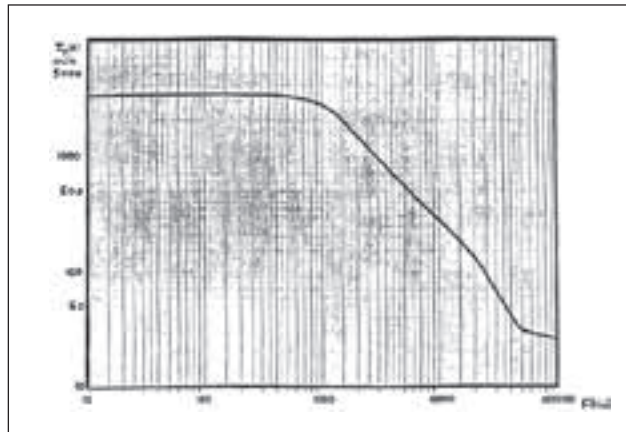

(1) Conditions of reference: 23 °C ± 3 °K, 20 % to 75 % RH, sinusoidal signal from frequency of 48 Hz to 65 Hz, external magnetic field < 40 A/m, no DC component, no external conductor with circulating current, conductor centred for measurement, load impedance > 1 MΩ / < 47 pF.

(2) Out of reference domain.

To order	Reference
AC current clamp model D38N with operating manual	P01120057A



B SERIES

The only model in the B series, the B102 is designed to measure earth leakage currents caused by insulation faults.

It enables the fault to be located and diagnosed before failure occurs thus avoiding installation shutdown.

It is designed specifically for locating low-current faults on high-current circuits.

The B102 measures differential or leakage current from 500 μ A upwards and may be used to measure currents up to 400 A in continuous use (400 A max.).

The B102 has two measurement ranges, 1 mV/mA or 1 mV/A.

As a leakage current detector, the B102 can be used on single or multiphase systems whether the currents are in or out of phase, balanced or unbalanced.

The B02 may be used simply as a high-precision clamp-on current probe.

With its 115 mm jaw opening and dynamic measurement range from 500 μ A to 400 A, the B102 is a versatile instrument, highly useful in the analysis of unbalanced circuits, leakage currents and earth loop currents.

When operated in conjunction with an artificial neutral, the B102 can also be used to measure fault currents on 3-phase circuits with no neutral.

(1) AN1 artificial neutral box (see chapter 13)

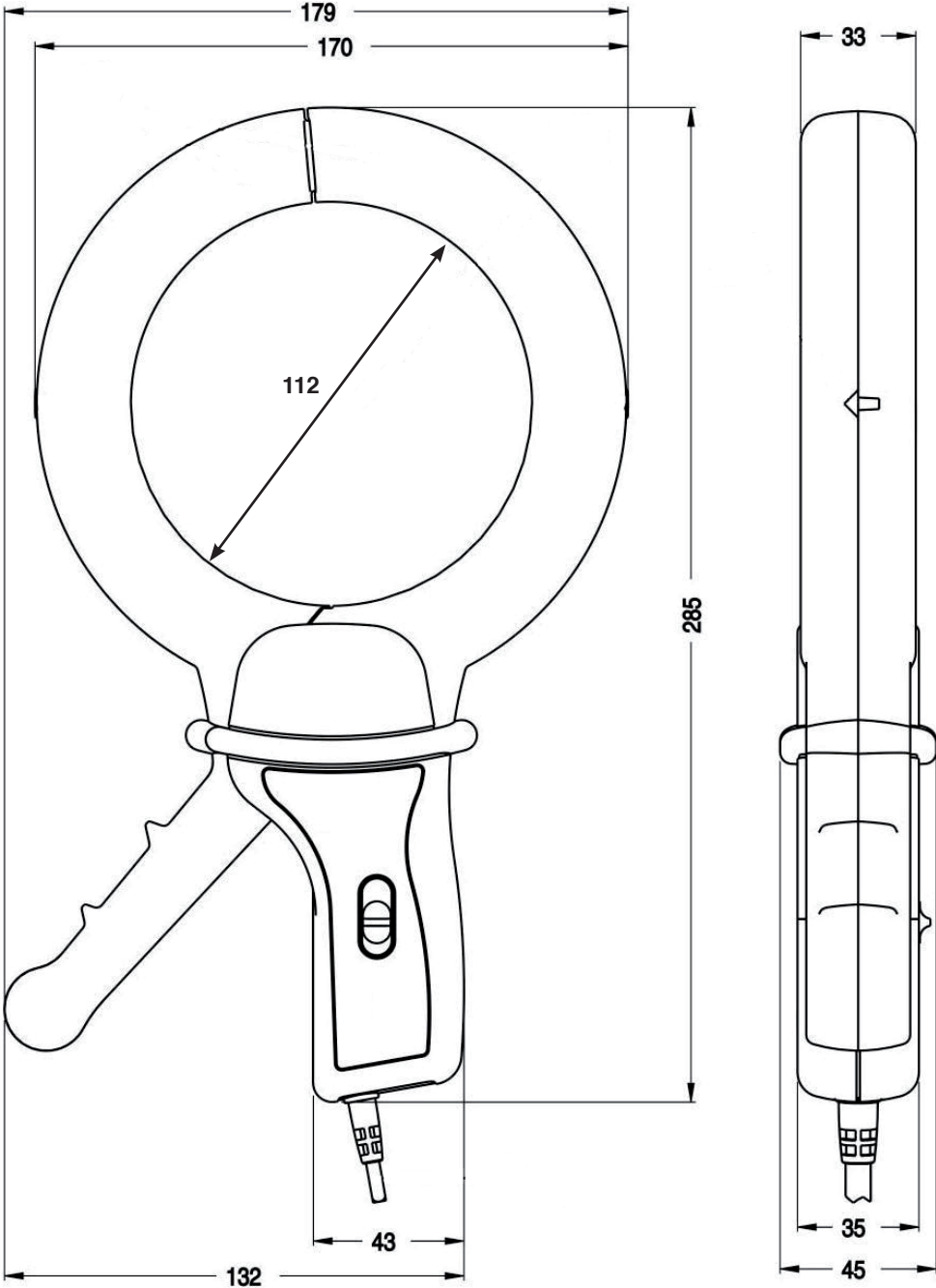

Current clamp for AC current

Model B102 (clamp for leakage currents)

B100 series

Current	4 AAC	400 AAC
Output	1 mV/mA	1 mV/A

DESCRIPTION

The B102 clamp measures leakage currents or residual currents as low as 500 µA and can be used with multimeters equipped with a calibre in mV AC. The B102 clamp measures the currents flowing in earth loops as well as leakage currents. It can be used on live installations to detect insulation faults on the earth circuits of single and three-phase networks. For three-wire three-phase systems, use the artificial neutral box.

ELECTRICAL SPECIFICATIONS

- Current range:**
0.5 mA AC .. 4 A AC
0.5 A AC .. 400 A AC
- Output signal:**
1 mV AC / mA AC (4 V for 4 A)
1 mV AC / A AC (0.4 V for 400 A)
- Accuracy and phase shift (1):**

Calibre	4 A		
Primary current	0.5 mA .. 10 mA	10 mA .. 100 mA	100 mA .. 4 A
Accuracy in % of output signal	≤ 3% + 1 mV	≤ 0.5% + 0.5 mV	≤ 0.5% + 0.5 mV
Phase shift	not specified	≤ 15°	≤ 10°

Calibre	400 A		
Primary current	0.5 mA .. 10 mA	10 A .. 200 A	200 A .. 400 A
Accuracy in % of output signal	≤ 0.5% + 0.5 mV	≤ 0.35% + 0.5 mV	≤ 0.35% + 0.5 mV
Phase shift	not specified	≤ 1°	≤ 0.7°

- Bandwidth:**
30 kHz .. 1 kHz (depending on current value)
- Maximum currents:**
400 A AC continuous for a frequency ≤ 1 kHz
Peak current < 1,000 A
- Load impedance:**
≥ 10 MΩ / 100 pF
- Max. voltage output:**
Electronic protection circuit limiting the voltage to 6 V peak max.
- Influence of temperature:**
Measurement: ≤ 100 ppm/K or 0.1 % of output signal per 10 °K
- Influence of adjacent conductor:**
0.4 mA/A typical at 50 Hz
- Influence of an external field:**
for 400 A calibre/m at 50 Hz
 - 4 A calibre: ≤ 60 mA
 - 400 A calibre: ≤ 0.1 A
- Influence of conductor position in jaws:**
≤ 0.1 % of the reading at 50/60 Hz (non-residual current)
≤ 0.2 % of the reading at 50/60 Hz (residual current)

- Influence of DC current superimposed on rated current AC:**
for a current DC from 1 A
 - 4 A calibre: ≤ 1 mA
 - 400 A calibre: ≤ 0.1 A
- Influence of frequency:**
 - 4 A calibre: ≤ 2 %
 - 400 A calibre: ≤ 0.5 % from 30 Hz to 1 kHz (limited to 100 A for 1 kHz)
- Influence of the measurement instrument's input impedance (Ze):**
 - 4 A calibre: $E\% = [Z_e / (Z_e + 4.8) - 1] * 100$
 - 400 A calibre: $E\% = [Z_e / (Z_e + 0.0048) - 1] * 100$

MECHANICAL SPECIFICATIONS

- Operating temperature:**
-10 °C to +55 °C
- Storage temperature:**
-40 °C to +70 °C
- Max. jaw insertion capacity:**
Cables: Ø 112 mm
Busbars: 1 busbar 20 x 50 mm
- Casing protection rating:**
IP40 with clamp closed (NF EN 60529 Ed. 95)
IP30 with jaws open

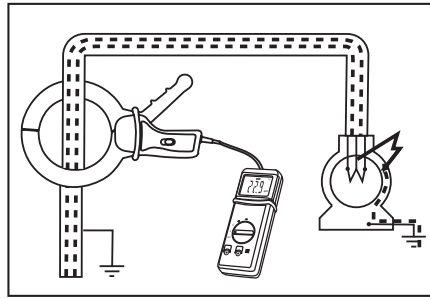

- Relative humidity for operation:**
0 to 85 % RH with a linear decrease above 35 °C
- Operating altitude:**
0 to 2,000 m
- Drop test:**
1 m (NF EN 61010-2-032)
- Self-extinguishing capability:**
Casing: V0 according to UL94
Jaws: V2 according to UL94
- Dimensions:**
285 x 175 x 43 mm
- Weight:**
1.3 kg approx.
- Colours:**
Casing: dark grey
Jaws: red
- Output:**
Cable with double insulation, length 1.5 m, terminated by 2 insulated elbowed male Ø 4 mm banana plugs

SAFETY SPECIFICATIONS

- Electrical safety:**
Instrument with double insulation or reinforced insulation between the primary, the secondary and the grippable part located under the guard as per EN 61010-1 Ed. 2: 2001, EN 61010-2-031 Ed. 2002 & EN 61010-2-032 Ed. 2003
- 600 V category III, pollution degree 2
- 300 V category IV, pollution degree 2
- Electromagnetic compatibility:**
CE-certified equipment compliant with standard EN 61326-1 (Ed. 97) + A1 (Ed. 98) + A2 (Ed. 01)
- Emission: regulations for class B equipment (domestic use)
- Immunity: regulations for equipment operated intermittently on industrial sites.

Current clamp for AC current

Model B102 (clamp for leakage currents)

B100 series



CURVES AT 50 HZ

4 A calibre

400 A calibre

Linearity for AC

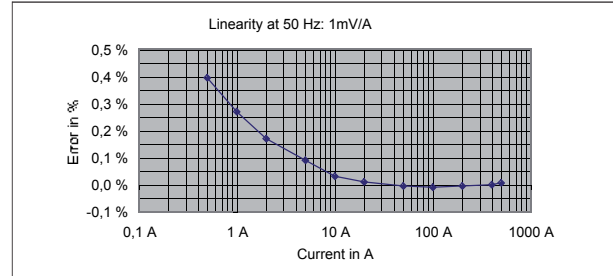
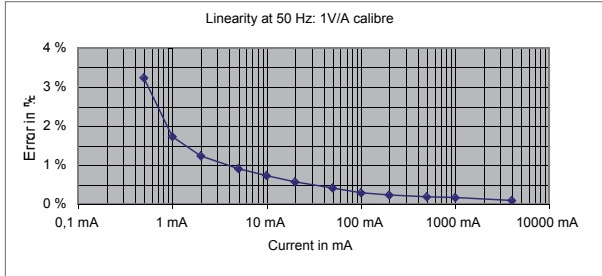

Phase shift

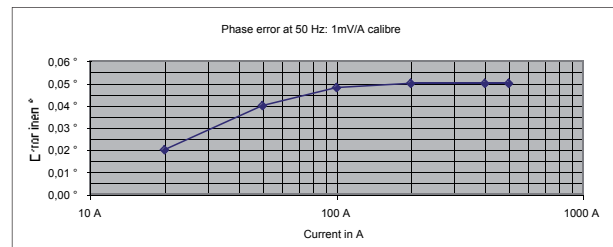
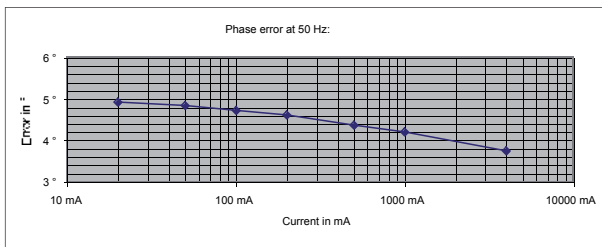

FREQUENCY RESPONSE

4 A calibre

400 A calibre

Typical error on measurement

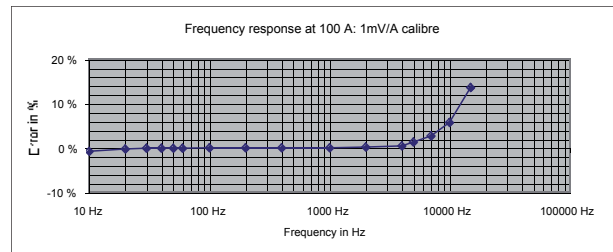
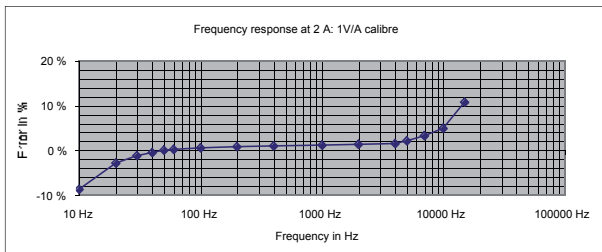

Typical phase shift

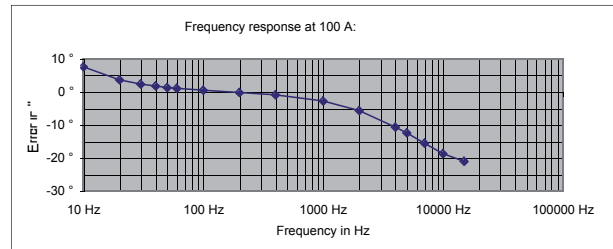
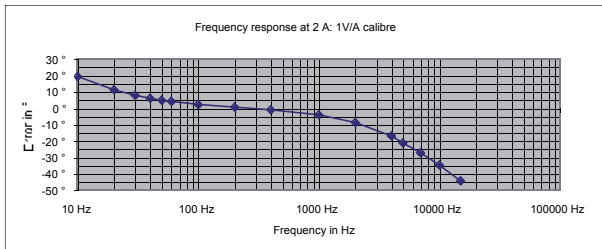

(1) Conditions of reference: 23°C ± 3°K, 20% to 75% RH, sinusoidal signal from frequency of 48 to 65 Hz, distortion factor < 1%, no DC components, external magnetic field < 40 A/m, no AC magnetic field, no external conductor with circulating current, conductor centred for measurement, load impedance ≥ 10 MΩ / ≤ 100 pF.

To order	Reference
AC current clamp model B102 with operating manual	P01120083
Accessories: AN1 artificial neutral box (see chapter 13) Hard case 320 x 255 x 75 mm	P01197201 P01298004



MiniFlex® SERIES

Making use of the principle of Rogowski coils, the MiniFlex® models are flexible sensors offering a wide dynamic range for measuring AC currents and viewing high-speed current pulses.

The sensor's output voltage is proportional to the derivative of the current measured in the conductor and requires an electronic system for formatting.

The absence of a magnetic core at the centre of the coil brings several advantages:

- flexibility and light weight
- excellent response to rapid current changes, as it is not possible for induced Fourier currents to occur, so they do not increase the sensor's response time.
- excellent linearity due to the absence of core saturation even when there are very high current, as in the case of electric power transmission, electrical welding or applications involving high-power pulses.

The great care taken when manufacturing our sensors means they benefit from particularly homogeneous winding, with equidistant turns along the whole length of the sensor, thus ensuring good immunity against electromagnetic interference.

The MiniFlex® models are made up of a flexible sensor connected to a casing containing processing electronics which outputs a voltage with the same amplitude and form as the current measured.

• MiniFlex® MA110 series:

With their small diameter and size, the sensors in the MA110 series are ideal for measuring currents in the electrical cabinets of residential or tertiary buildings or in low-power cabinets in industry. The rugged click-together system benefits from IP67 ingress protection.

Available with "banana" or "BNC" connection technology, the MA110 series can be connected directly to a multimeter, a wattmeter or a logger for RMS measurements at the standard industrial frequencies. The casing offers 4 measurement calibres.

• MiniFlex® MA130:

The MA130 sensor, part of the same series as the MA110, can be used to measure currents on three-phase installations. It is equipped with BNC connections with adapters for banana plugs. The processing unit offers 3 measurement calibres. The rugged click-together system has IP67 ingress protection. It can be connected to the AC voltage inputs (mV AC, AC) of any power analyser, logger or other measuring instrument.

• MiniFlex® MA200 series:

The MA200 series is a family of "high-frequency" sensors specially designed for viewing and measuring electrical or electrotechnical signals with wide variations and high amplitude. These "insulated current probes for oscilloscopes" offer a bandwidth of 1 MHz and can be used to analyse currents with complex forms, transients present in electronic power supplies, welding units, etc.

MA110 - MA130 SERIES

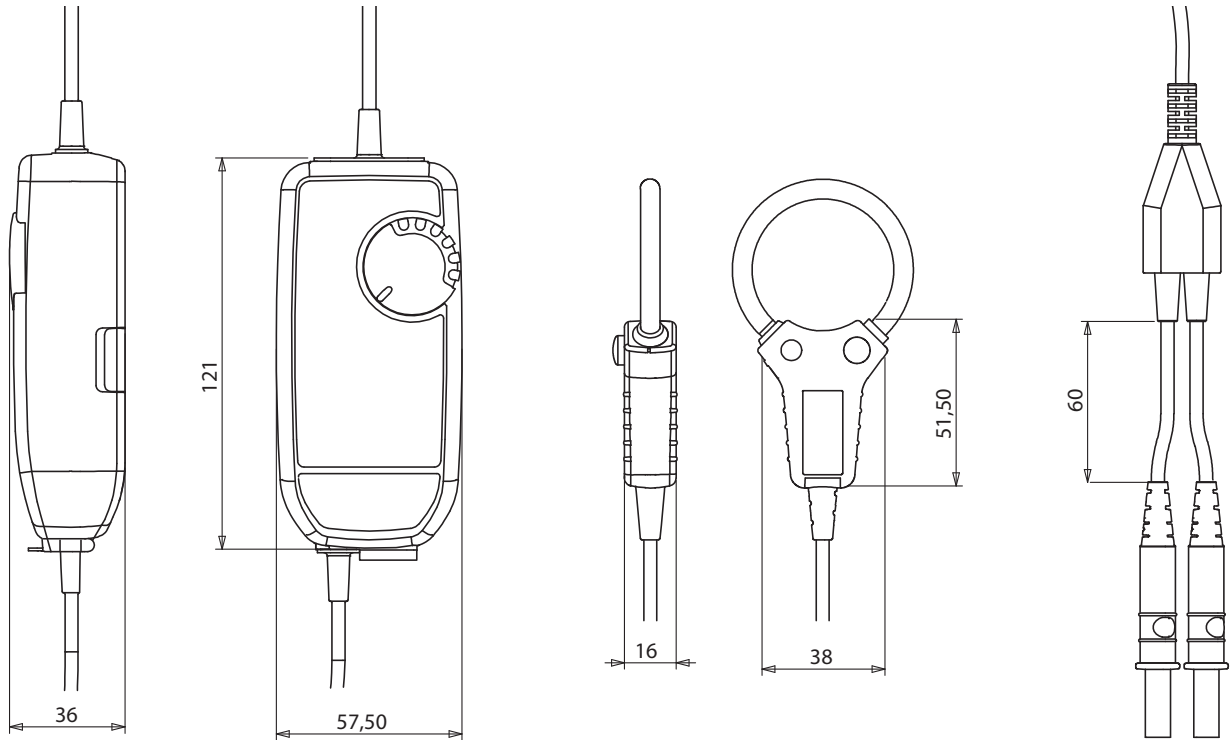

MA200 SERIES

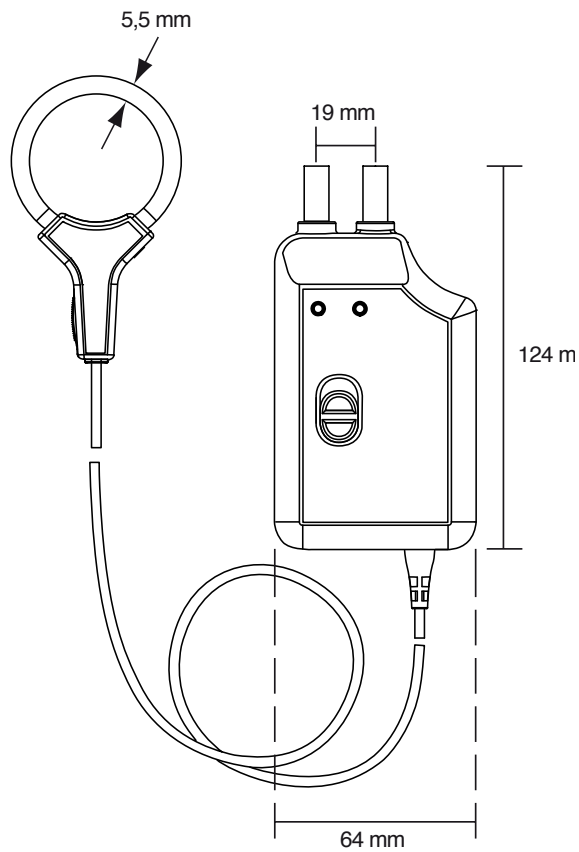

Flexible probe for AC current

Model MA110 3-30-3000-3000/3

MiniFlex® series

Current	3 A AC	30 A AC	300 A AC	3,000 A AC
Output	1 mV/mA	100 mV/A	10 mV/A	1 mV/A

DESCRIPTION

The model MA110 MiniFlex® sensor is a flexible sensor comprising an active part (Rogowski coil) linked to a casing containing electronics.

Unlike a current clamp with magnetic circuits, the MiniFlex® models are flexible and are not subject to magnetic saturation constraints, so they offer excellent linearity, low phase shift and a large dynamic range for measurement (up to several kA) while remaining easy to use. The sensors' flexibility makes it simple to clamp and measure any conductor, whatever its type (cable, busbar, strand, etc. and accessibility). The click-lock system for opening and closing the coil is specially designed for use with safety gloves.

The MA110 MiniFlex® sensor can be connected to the AC voltage input of any multimeter with Ø 4 mm female plugs.

The MiniFlex® MA110 model can be powered by batteries or by a standard external power supply. If the power supply fails, the instrument's batteries take over.

To maximize the battery life, the MiniFlex® MA110 model has an automatic standby system which can be deactivated at start-up to perform long-term measurement campaigns.

The MiniFlex® MA110 model has 3 green, yellow and red LEDs indicating, respectively, the power supply status, the status of the automatic standby function and any overruns of the measurement capacity.



SPECIFICATIONS FOR CURRENT MEASUREMENT ⁽¹⁾

Calibre (I _N)	3 A	30 A	300 A	3000 A
Measurement range in use	0.08 .. 3 A AC	0.5 .. 30 A AC	0.5 .. 300 A AC	0.5 .. 3000 A AC
Specified measurement range	0.5 .. 3 A AC	5 .. 30 A AC	5 .. 300 A AC	50 .. 3000 A AC
Output/input ratio	1 V/A (1 mV / mA)	100 mV / A	10 mV / A	1 mV / A
Bandwidth at -3 dB	10 Hz .. 10 kHz	10 Hz .. 20 kHz	10 Hz .. 20 kHz	10 Hz .. 20 kHz
Frequency limitation	Null	Null	Null	See curve
Intrinsic uncertainty	≤ 1 % + 40 mV	≤ 1 % + 4 mV	≤ 1.5 % + 0.4 mV (I < 10 % I _N) ≤ 1 % + 0.4 mV (I ≥ 10 % I _N)	≤ 1.5 % + 0.04 mV (I < 10 % I _N) ≤ 1 % + 0.04 mV (I ≥ 10 % I _N)
Phase shift at 50 Hz	≤ 1° (0.5° typical)	≤ 1° (0.5° typical)	≤ 1° (0.5° typical)	≤ 1° (0.5° typical)

ELECTRICAL SPECIFICATIONS ⁽¹⁾

- Operating voltage:**
 600 V_{RMS} (Cat. IV)
 1,000 V_{RMS} (Cat. III)
- Battery:**
 Two 1.5 V batteries (NEDA 15A, IEC LR6, AA)
 +5 VDC with a type B micro-USB connector
- Battery life ⁽²⁾:**
 300 hours typical
 1,800 10-minute approx. measurements
- Consumption:**
 10 µA (OFF position)
 90 µA (sleep mode)
- Battery level indication:**
 Flashing green LED (batteries voltage > 2 V)
- Influence of battery voltage:**
 ≤ 0.1 % (0.02 % typical) from 3.1 V to 2 V
- Influence of temperature:**
 ≤ 0.5 % (0.15 % typical) of output signal per 10 °K
- Influence of relative humidity:**
 ≤ 0.5 % (0.2 % typical) of output signal
- Influence of conductor position in the sensor ⁽³⁾:**
 ≤ 2.5 % (1 % typical)
- Influence of sensor deformation ⁽⁴⁾:**
 ≤ 1 % (0.2 % typical)
- Influence of adjacent conductor ⁽⁵⁾:**
 ≤ I_{ADJ} × 1 % (2 % near click-lock system)
 (0.2 % typical)
- Input impedance of the measuring instrument:**
 ≥ 1 MΩ
- Common mode rejection ⁽⁶⁾:**
 ≤ 80 dB (100 dB typical)
- Influence of the measurement instrument's impedance Z:**
 ≤ 0.1 % at 10 kΩ

Flexible probe for AC current

Model MA110 3-30-3000-3000/3

MiniFlex® series

MECHANICAL SPECIFICATIONS ⁽¹⁾

- Clamping capacity:**
 Model 170 mm: Ø max 45 mm
 Model 250 mm: Ø max 70 mm
 Model 350 mm: Ø max 100 mm
- Bending radius:**
 ≥ 20 mm
- Operating temperature:**
 -10 °C to +55 °C
- Storage temperature:**
 -40 °C to +70 °C
- Max. temperature of clamped conductor (measured):**
 90 °C for 10 minutes max.
- Relative humidity for operation:**
 0 to 85 % RH with a linear decrease above 35 °C
- Operating altitude:**
 0 to 2,000 m
- Casing protection rating (leakproofing):**
 Casing: IP54
 Sensor: IP 67
 According to IEC 60529 Ed. 2.2-2013
- Drop test:**
 1 m
- Self-extinguishing capability:**
 Casing: UL94-V2
 Sensor: UL94 V0
- Dimensions:**
 Casing: 120 x 55 x 39 (overall)
 Length of intermediate cable linking the sensor/ processing unit: 2 m
 Length of output cable: 0.5 m
 Ø of sensor: 6 mm
 Connection cable Ø: 4 mm
- Weight:**
 Model 170 mm: 300 g
 Sensor: 5 g / 10 cm
- Colours:**
 Sensor: red
 Sensor closing system: dark grey
 Casing: dark grey
- Output:**
 Two-wire cable with reinforced or double insulation terminated by 2 red and black isolated male banana plugs Ø 4 mm

SAFETY SPECIFICATIONS

- Electrical safety:**
 Class II equipment with double or reinforced insulation between the primary and the secondary (winding connected to the connection cable) as per EN 61010-1 and 61010-2-032:
Sensor:
 - Type B
 - 600 V Cat. IV / 1,000 V Cat. III, pollution degree 2
Casing:
 - 600 V Cat. IV between the terminals and the external enclosure of the casing
- Electromagnetic compatibility (EMC):**
 Complies with the industrial environments according to EN 61326-1 Ed. 02-2012:
 - Immunity to radiated fields: at 3 V/m, error ≤ 5% of measuring range (criterion A)

3,000 A calibre

Frequency limitation according to amplitude

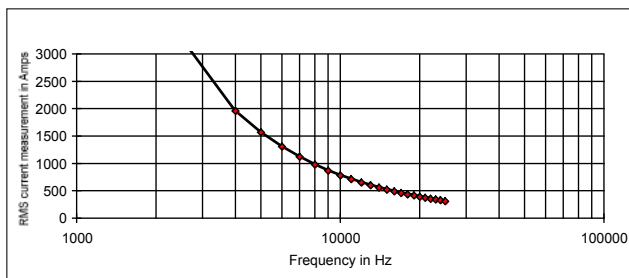

- (1) Conditions of reference: 23 °C ± 5 °K, 20 % to 75 % RH
 Battery voltage 3.2 V ± 0.1 VDC
 Frequency and form of signal measured: 30 to 440 Hz sinusoidal
 Continuous magnetic field < 40 A/m
 Absence of external AC magnetic field
 Absence of external electrical field
 Measured conductor centred in the circular sensor (coil) after operation for 1 minute
 Measurement instrument input impedance ≥ 1 MΩ
- (2) With 3,000 mA/h batteries, for a supplied voltage between 3.2 V and 1.8 V (1.6 V to 0.9 V per battery), giving an average voltage of 2.8 V
- (3) Whatever the conductor's position within the loop, as long as the sensor is not distorted (circular sensor)
- (4) Oblong shape
- (5) Adjacent conductor carrying an AC current I_{adj} , in contact with the sensor
- (6) For a 600 V voltage applied between the enclosure and the secondary

To order	Reference
MiniFlex® MA110 3-30-300-3,000 A / 3 V , length 170 mm , Output via cable terminated by 2 x Ø 4 mm isolated male banana plugs	P01120660
MiniFlex® MA110 3-30-300-3,000 A / 3 V , length 250 mm , Output via cable terminated by 2 x Ø 4 mm isolated male banana plugs	P01120661
MiniFlex® MA110 3-30-300-3,000 A / 3 V , length 350 mm , Output via cable terminated by 2 x Ø 4 mm isolated male banana plugs	P01120662

Flexible probe for AC current

Model MA110 3-30-3000-3000/3

MiniFlex® series



FREQUENCY RESPONSE

Calibre 3 A

Typical error on measurement according to frequency for a current of 2 A

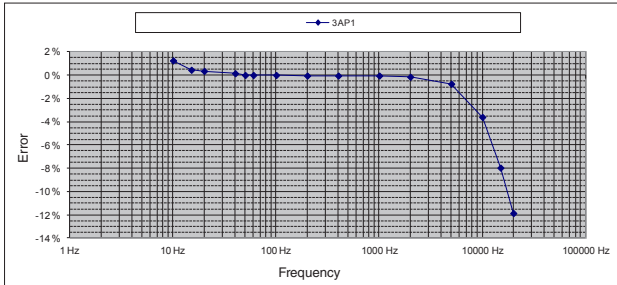

30 A calibre

Typical error on measurement according to frequency for a current of 20 A

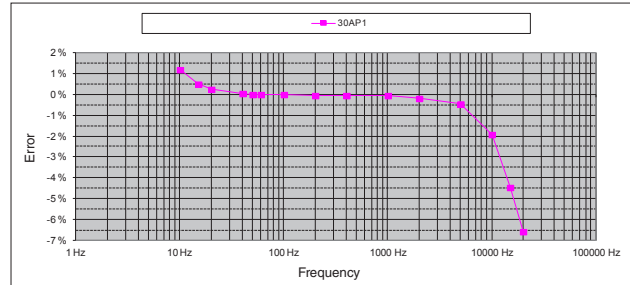

Typical phase shift according to frequency for a current of 2 A

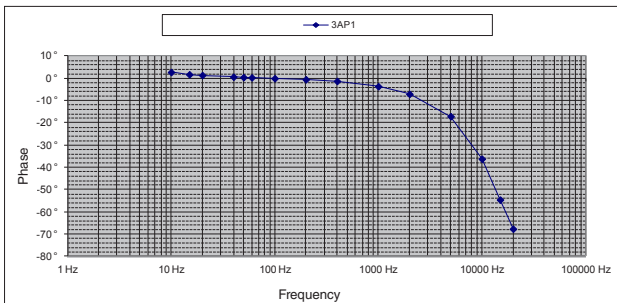

Typical phase shift according to frequency for a current of 20 A

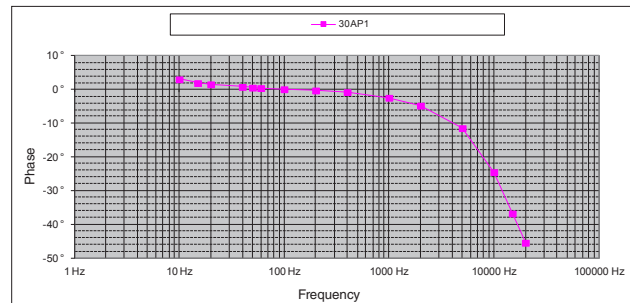

300 A calibre

Typical error on measurement according to frequency for a current of 20 A

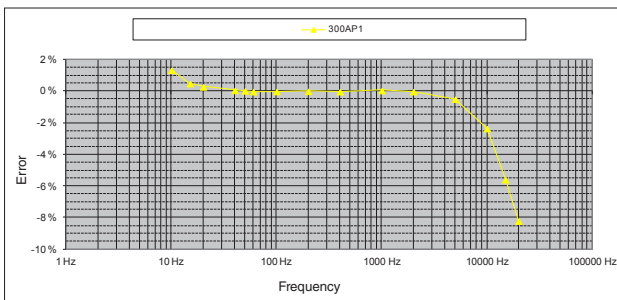

3,000 A calibre

Typical error on measurement according to frequency for a current of 20 A

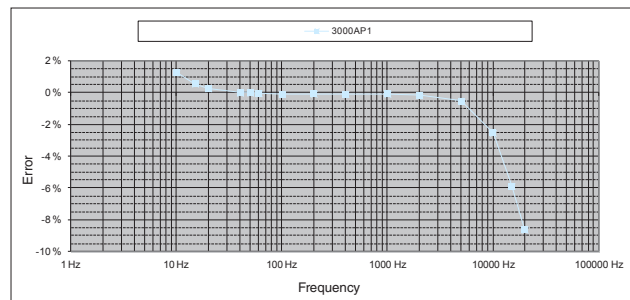

Typical phase shift according to frequency for a current of 20 A

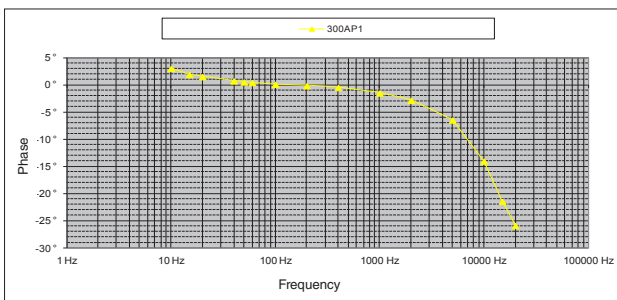

Typical phase shift according to frequency for a current of 20 A

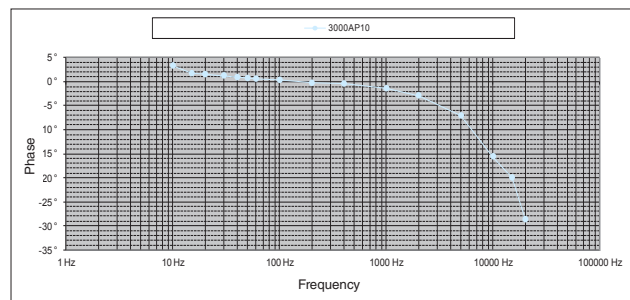

Flexible probe for AC current

Model MA110 on request

MiniFlex® series



CONFIGURATIONS

Level 1

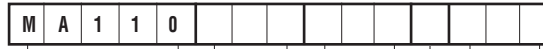

1 Category

2 Lead length in centimeters

Min value : **015** (15 cm)
 Max value : **100** (100 cm = 1 m)

Increment per 5 cm section

3 Length of connection lead in centimeters

Min value : **050** (50 cm)
 Max value : **995** (9.95 m)

Increment per 5 cm section

4 Output via

A: coaxial cable of the length to be defined in 5 terminated by a 600 V CAT III isolated male BNC socket

B: cable 50 cm long terminated by 2 red/black Ø 4 mm isolated male banana plugs rated 600 V CAT IV

C: shielded cable with 2 bared, tin-plated conductors of the length to be defined in 5, rated 600 V CAT IV

5 Output cable length in cm

If 4 = "A"

Min value : **050** (50 cm)
 Max value : **110** (1.10 m)

Increment per 5 cm section

If 4 = "C"

Min value : **050** (50 cm)
 Max value : **995** (9.95 m)

Increment per 5 cm section

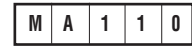

On request - Modulo 5 cm
 Coding over 3 characters
 E.g. 50 cm = 050; 1 m = 100



On request - Modulo 5 cm
 Coding over 3 characters
 E.g. 50 cm = 050; 9 m = 900



On request - Modulo 5 cm
 Coding over 3 characters
 E.g. 50 cm = 050; 1.10 m = 110

References: (products available in stock)	Codes															
<table border="1"> <tr> <td>M</td><td>A</td><td>1</td><td>1</td><td>0</td><td>0</td><td>2</td><td>5</td><td>2</td><td>0</td><td>0</td><td>B</td><td>0</td><td>5</td><td>0</td> </tr> </table>	M	A	1	1	0	0	2	5	2	0	0	B	0	5	0	P01120661
M	A	1	1	0	0	2	5	2	0	0	B	0	5	0		
<table border="1"> <tr> <td>M</td><td>A</td><td>1</td><td>1</td><td>0</td><td>0</td><td>3</td><td>5</td><td>2</td><td>0</td><td>0</td><td>B</td><td>0</td><td>5</td><td>0</td> </tr> </table>	M	A	1	1	0	0	3	5	2	0	0	B	0	5	0	P01120662
M	A	1	1	0	0	3	5	2	0	0	B	0	5	0		

Current	30 A AC	300 A AC	3,000 A AC
Output	100 mV/A	10 mV/A	1 mV/A

DESCRIPTION

The MiniFlex® MA130 is a flexible sensor comprising an active part (Rogowski coil) linked to a casing containing electronics.

Unlike a current clamp with magnetic circuits, the MiniFlex® models are flexible and are not subject to magnetic saturation constraints, so they offer excellent linearity, low phase shift and a large dynamic range for measurement (up to several kA) while remaining easy to use.

The sensors' flexibility makes it simple to clamp and measure any conductor, whatever its type (cable, busbar, strand, etc. and accessibility).

The click-lock system for opening and closing the coil is specially designed for use with safety gloves.

The MiniFlex® MA130 can be connected to the AC voltage inputs (mV AC, V AC) of any power analyser, logger or measuring instrument equipped with BNC plugs.

The MiniFlex® MA130 can be powered by batteries or a standard external power supply. If the power supply fails, the instrument's batteries take over.

To maximize the battery life, the MiniFlex® MA130 model has an automatic standby system which can be deactivated at start-up to perform long-term measurement campaigns. The MiniFlex® MA130 model has 3 green, yellow and red LEDs indicating, respectively, the power supply status, the status of the automatic standby function and any overruns of the measurement capacity.



SPECIFICATIONS FOR CURRENT MEASUREMENT ⁽¹⁾

Calibre (I _N)	30 A	300 A	3000 A
Measurement range in use	0.5 .. 30 A AC	0.5 .. 300 A AC	0.5 .. 3000 A AC
Specified measurement range	5 .. 30 A AC	5 .. 300 A AC	50 .. 3000 A AC
Output/input ratio	100 mV / A	10 mV / A	1 mV / A
Bandwidth at -3 dB	10 Hz .. 20 kHz	10 Hz .. 20 kHz	10 Hz .. 20 kHz
Frequency limitation	Null	Null	See curve
Intrinsic uncertainty	≤ 1 % + 4 mV	≤ 1.5 % + 0.4 mV (I < 10 % I _N) ≤ 1 % + 0.4 mV (I ≥ 10 % I _N)	≤ 1.5 % + 0.04 mV (I < 10 % I _N) ≤ 1 % + 0.04 mV (I ≥ 10 % I _N)
Phase shift at 50 Hz	≤ 1° (0.5° typical)	≤ 1° (0.5° typical)	≤ 1° (0.5° typical)

ELECTRICAL SPECIFICATIONS ⁽¹⁾

- Operating voltage:**
 600 V_{RMS} (Cat. IV)
 1,000 V_{RMS} (Cat. III)
- Battery:**
 Two 1.5 V batteries (NEDA 15A, IEC LR6, AA)
 +5 VDC with a type B micro-USB connector
- Battery life ⁽²⁾:**
 500 hours typical
 3,000 10-minute approx. measurements
- Consumption:**
 10 µA (OFF position)
 90 µA (sleep mode)
- Battery level indication:**
 Flashing green LED (batteries voltage > 2 V)
- Influence of battery voltage:**
 ≤ 0.1 % (0.02 % typical) from 3.1 V to 2 V
- Influence of temperature:**
 ≤ 0.5 % (0.15 % typical) of output signal per 10 °K
- Influence of relative humidity:**
 ≤ 0.5 % (0.2 % typical) of output signal
- Influence of conductor position in the sensor ⁽³⁾:**
 ≤ 2.5 % (1 % typical)
- Influence of sensor deformation ⁽⁴⁾:**
 ≤ 1 % (0.2 % typical)
- Influence of adjacent conductor ⁽⁵⁾:**
 ≤ I_{ADJ} x 1 % (2 % near click-lock system)
 (0.2 % typical)
- Input impedance of the measuring instrument:**
 ≥ 1 MΩ
- Common mode rejection ⁽⁶⁾:**
 ≤ 80 dB (100 dB typical)
- Influence of the measurement instrument's impedance Z:**
 ≤ 0.1 % at 10 kΩ

MECHANICAL SPECIFICATIONS

- **Clamping capacity:**
Model 250 mm: Ø max 70 mm
- **Bending radius:**
≥ 20 mm
- **Operating temperature:**
-10 °C to +55 °C
- **Storage temperature:**
-40 °C to +70 °C
- **Max. temperature of clamped conductor (measured):**
90 °C for 10 minutes max.
- **Relative humidity for operation:**
0 to 85 % RH with a linear decrease above 35 °C
- **Operating altitude:**
0 to 2,000 m
- **Casing protection rating (leakproofing):**
Casing: IP54
Sensor: IP 67
According to IEC 60529 Ed. 2.2-2013

- **Drop test:**
1 m (IEC 68-2-32)
- **Self-extinguishing capability:**
Casing: UL94-V2
Sensor: UL94 V0
- **Dimensions:**
Casing: 120 x 55 x 39 (overall)
Length of intermediate cable linking the cable/processing unit: 3 m
Length of output cable: 0.5 m
Ø of sensor: 6 mm
Connection cable Ø: 4 mm
- **Weight:**
500 g
- **Colours:**
Sensor: red
Sensor closing system: dark grey
Casing: dark grey
- **Output:**
3 coaxial cables with reinforced or double isolation terminated by 1 black isolated male BNC plug

SAFETY SPECIFICATIONS

- **Electrical safety:**
Class II equipment with double or reinforced insulation between the primary and the secondary (winding connected to the connection cable) as per EN 61010-1 and 61010-2-032:
Sensor:
- Type B
- 600 V Cat. IV / 1,000 V Cat. III, pollution degree 2
Casing:
- 600 V Cat. III between the BNC output and the external enclosure of the casing
- **Electromagnetic compatibility (EMC):**
Compliance for industrial environments as per EN 61326-1 Ed. 02-2012:
- Immunity to radiated fields: at 3 V/m, error ≤ 5 % of measurement range (criterion A)

3,000 A calibre

Frequency limitation according to amplitude

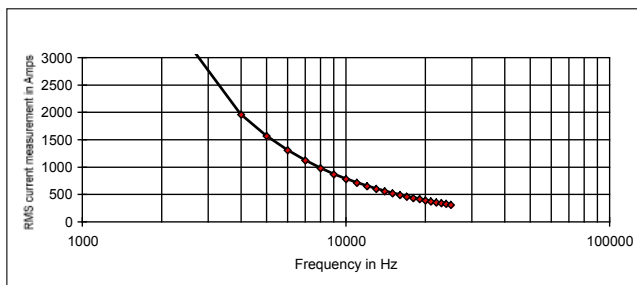

- (1) Conditions of reference: 23 °C ± 5 °K, 20 % to 75 % RH
Battery voltage 3.2 V ± 0.1 V DC
Frequency and form of signal measured: 30 to 440 Hz sinusoidal
Continuous magnetic field < 40 A/m
Absence of external AC magnetic field
Absence of external electrical field
Measured conductor centred in the circular sensor (coil) after operation for 1 minute
Measurement instrument input impedance ≥ 1 MΩ
- (2) With 3,000 mA/h batteries, for a supplied voltage between 3.2 V and 1.8 V (1.6 V to 0.9 V per battery), giving an average voltage of 2.8 V
- (3) Whatever the conductor's position within the loop, as long as the sensor is not distorted (circular sensor)
- (4) Oblong shape
- (5) Adjacent conductor carrying an AC current I_{adj} , in contact with the sensor
- (6) For a 600 V voltage applied between the enclosure and the secondary
- (7) Delivered with a set of 3 female BNC/ Ø 4 mm isolated male banana adapters with 19 mm spacing and a set of identifiers (12 colours)

To order	Reference
MiniFlex® MA130 30-300-3,000 A / 3 V, length 250 mm, Output via 3 coaxial cables terminated by 1 isolated male BNC plug	P01120663

Flexible probe for AC current

Model MA130 30-300-3000/3 triphase

MiniFlex® series



FREQUENCY RESPONSE

30 A calibre

Typical error on measurement according to frequency for a current of 20 A

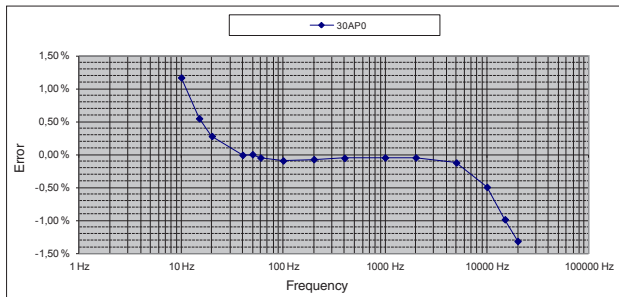

Typical phase shift according to frequency for a current of 20 A

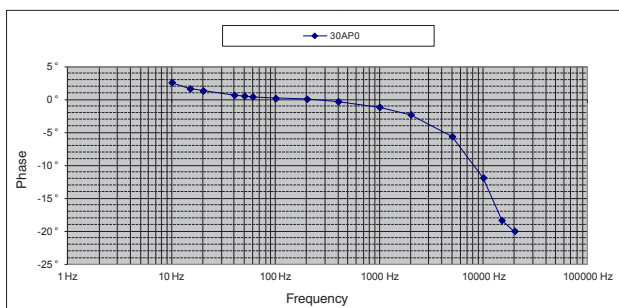

300 A calibre

Typical error on measurement according to frequency for a current of 20 A

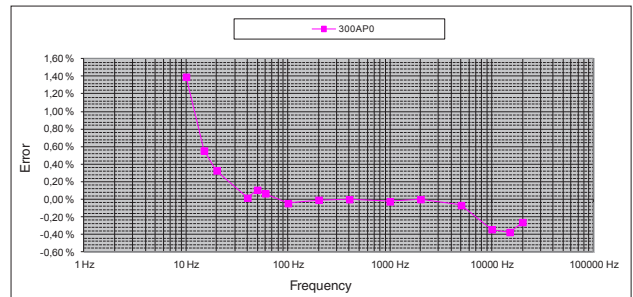

Typical phase shift according to frequency for a current of 20 A

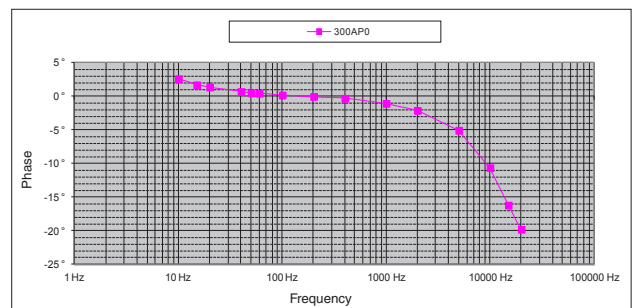

3,000 A calibre

Typical error on measurement according to frequency for a current of 20 A

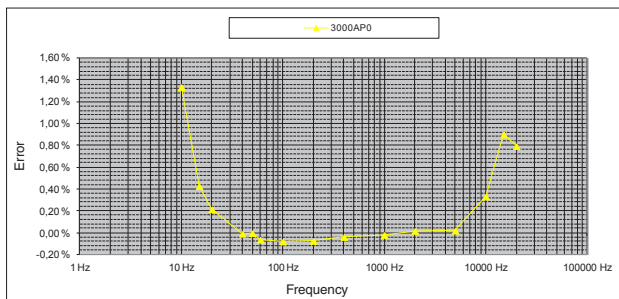

Typical phase shift according to frequency for a current of 20 A

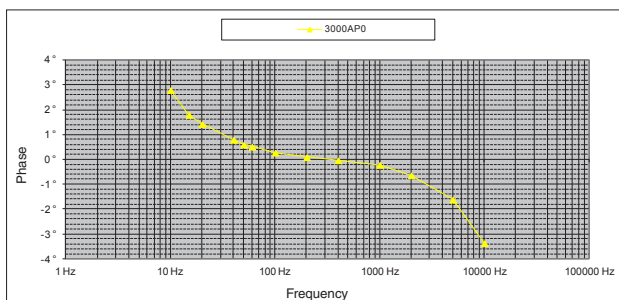

Flexible probe for AC current

Model MA130 on request

MiniFlex® series



CONFIGURATIONS

Level 1

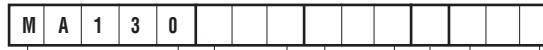

1 Category

2 Lead length in centimeters

Min value : **015** (15 cm)
 Max value : **100** (100 cm = 1 m)

Increment per 5 cm section

3 Length of connection lead in centimeters

Min value : **050** (50 cm)
 Max value : **995** (9.95 m)

Increment per 5 cm section

4 Output via

- A:** coaxial cable of the length to be defined in **5** terminated by a 600 V CAT III isolated male BNC socket
- B:** cable 50 cm long terminated by 2 red/black Ø 4 mm isolated male banana plugs rated 600 V CAT IV
- C:** shielded cable with 2 bared, tin-plated conductors of the length to be defined in **5**, rated 600 V CAT III

5 Output cable length in cm

If **4** = "A"

Min value : **050** (50 cm)
 Max value : **110** (1.10 m)

Increment per 5 cm section

If **4** = "C"

Min value : **050** (50 cm)
 Max value : **995** (9.95 m)

Increment per 5 cm section

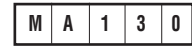

On request - Modulo 5 cm
 Coding over 3 characters
 E.g. 50 cm = 050; 1 m = 100

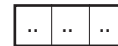

On request - Modulo 5 cm
 Coding over 3 characters
 E.g. 50 cm = 050; 9 m = 900



On request - Modulo 5 cm
 Coding over 3 characters
 E.g. 50 cm = 050; 1.10 m = 110

Reference: (products available in stock)	Codes
	P01120663

Current	45 A peak	450 A peak
Output	100 mV/A	10 mV/A

DESCRIPTION

The MiniFlex® MA200 is a flexible sensor comprising an active part (Rogowski coil) linked to a casing containing electronics.

Unlike a current clamp with magnetic circuits, the MiniFlex® models are flexible and are not subject to magnetic saturation constraints, so they offer excellent linearity, low phase shift and a large dynamic range for measurement (up to several kA) while remaining easy to use.

The oscilloscope probes in the MA200 series are specially designed for viewing alternating currents in order to assess the transition and propagation times on electrotechnical equipment.

The sensors' flexibility makes it simple to clamp and measure any conductor, whatever its type (cable, busbar, strand, etc.) and accessibility.

The click-lock system for opening and closing the coil is specially designed for use with safety gloves.

The casing can be connected to any oscilloscope equipped with an AC voltage input.

SPECIFICATIONS FOR CURRENT MEASUREMENT ⁽¹⁾

Calibre	30 A	300 A
Measurement range in use	0.5 .. 30 A AC (45 A peak)	0.5 .. 300 A AC (450 A peak)
Specified measurement range ⁽²⁾	5 .. 30 A AC (45 A peak)	5 .. 300 A AC (450 A peak)
Output/input ratio	100 mV/A	10 mV/A
% Accuracy of output signal	≤ 1 % + 0.3 A	
Phase shift at 1 kHz	≤ 1.5°	
Residual current (noise) at I = 0	≤ 0.5 A _{RMS}	
Output impedance	1 kΩ	

FREQUENCY MEASUREMENT SPECIFICATIONS ⁽¹⁾

Calibre	30 A	300 A
Bandwidth at -3 dB	2 Hz .. 1 MHz	2 Hz .. 1 MHz
Rise time ⁽³⁾ (10 to 90 %)	0.3 μs (typical)	0.24 μs (typical)
Fall time ⁽⁴⁾ (10 to 90 %)	0.3 μs (typical)	0.24 μs (typical)
Propagation time ⁽⁵⁾ (to 10 %)	0.4 μs (typical)	0.3 μs (typical)
Insertion impedance at 10 kHz	< 0.05 mΩ	



ELECTRICAL SPECIFICATIONS ⁽¹⁾

- **Operating voltage:**
600 V_{RMS} (Cat. IV)
1,000 V_{RMS} (Cat. III)
- **Battery:**
9 V alkaline battery (NEDA 1604A, IEC 6LR61)
- **Battery life:**
100 hours typical
- **Typical consumption:**
3.6 mA typical
- **Battery level indication:**
Green LED when > 7.0 V approx.
- **Influence of battery voltage:**
≤ 0.1 % from 9 V to 7 V
- **Influence of temperature:**
≤ 0.2 % / 10 °K
- **Influence of humidity:**
≤ 0.5 % from 10 % to 90 % RH without condensation
- **Influence of conductor position in the sensor ⁽⁸⁾:**
≤ 2.5 %
- **Influence of sensor deformation ⁽⁶⁾:**
≤ 1 %
- **Influence of an adjacent conductor with circulating AC current ⁽⁷⁾:**
≤ 1.5 % or 36.5 dB
- **Common mode rejection:**
- between enclosure and secondary: ≤ 75 dB
- between sensor and secondary: ≤ 80 dB
- **Influence of the measurement instrument's impedance Z:**
0.1 % / Z (in MΩ)

MECHANICAL SPECIFICATIONS

- **Clamping capacity:**
Model 170 mm: Ø max 45 mm
Model 250 mm: Ø max 70 mm
- **Operating temperature:**
-10 °C to +55 °C
- **Storage temperature:**
-40 °C to +70 °C
- **Max. temperature of clamped conductor (measured):**
≤ 90 °C
- **Relative humidity for operation:**
0 to 85 % RH with a linear decrease above 35 °C
- **Operating altitude:**
0 to 2,000 m
- **Storage altitude:**
≤ 12,000 m
- **Casing protection rating (leakproofing):**
Casing: IP50
Sensor: IP50
According to EN 60529/A1 Ed. 06/2000
- **Shock resistance:**
IK04 according to NF EN 50102 Ed. 1995
- **Self-extinguishing capability:**
Casing: UL94-V2
Sensor: UL94 V0
- **Dimensions:**
Casing: 140 x 64 x 28 mm
Connector lead: 2 m (connects sensor to casing)
Ø of sensor: 5.5 mm approx.
Connection cable Ø: 3 mm approx.

- **Colours:**
Sensor: red
Sensor closing system: dark grey
Sensor locking tab: yellow
Casing: Dark grey
- **Output:**
According to model:
Coaxial cable 40 cm long, terminated by an insulated BNC plug

SAFETY SPECIFICATIONS

- **Electrical safety:**
Class II equipment with double or reinforced insulation between the primary and the secondary (winding connected to the connection cable) as per EN 61010-1 and 61010-2-032:
- 1,000 V Cat. III, pollution degree 2
- 600 V Cat. IV, pollution degree 2
- Type-B sensor
- 600 V Cat. III between the BNC output and the external enclosure of the casing
- **Electromagnetic compatibility (EMC):**
Complies with the IEC 61326 (Ed. 1997) + A1 (Ed. 1998)
- Adequate immunity to disturbances for industrial environments
- Adequate immunity to disturbances for residential environments

(1) Conditions of reference: 23 °C ± 5 °K, 20 % to 75 % RH
Battery voltage: 9 V ± 0.5 V
Continuous external DC magnetic field (earth field) < 40 A/m
Absence of external AC magnetic field
External electrical field < 1 V/m
Position of conductor measured: centred in the measurement coil
Shape of measurement coil: quasi-circular
Measurement instrument input impedance (oscilloscope) ≥ 1 MΩ
Frequency and form of signal measured: 40 to 400 Hz sinusoidal.

(2) Measurement range for the specifications indicated in this document.

(3) Rise Time (t_r)

(4) Fall Time (t_f)

(5) Delay Time (d_t)

(6) Oblong shape

(7) Adjacent conductor 1 cm from sensor; ≤ 3 % or 30.5 dB near click-lock system

(8) ≤ 6 % near click-lock system

(9) Typical curve obtained by mathematical modelling

To order	Reference
MiniFlex® MA200 30-300 A / 3 V, length 170 mm with operating manual and Battery	P01120570
MiniFlex® MA200 30-300 A / 3 V, length 250 mm with operating manual and Battery	P01120571

Flexible probe for AC current

MiniFlex® series

Model MA200 30-300/3 (insulated AC current probe)

170 mm LOOP - 30 A CALIBRE

Frequency and phase responses ⁽⁹⁾

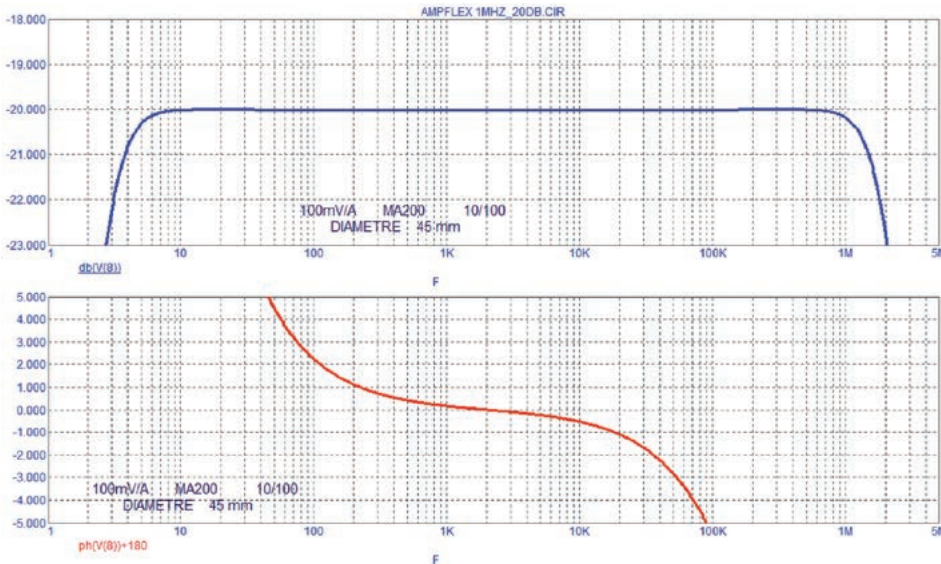

Pulse response

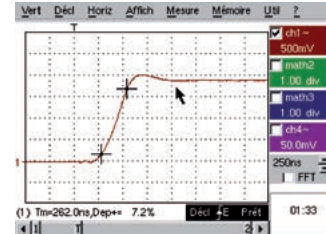

170 mm LOOP- 300 A CALIBRE

Frequency and phase responses ⁽⁹⁾

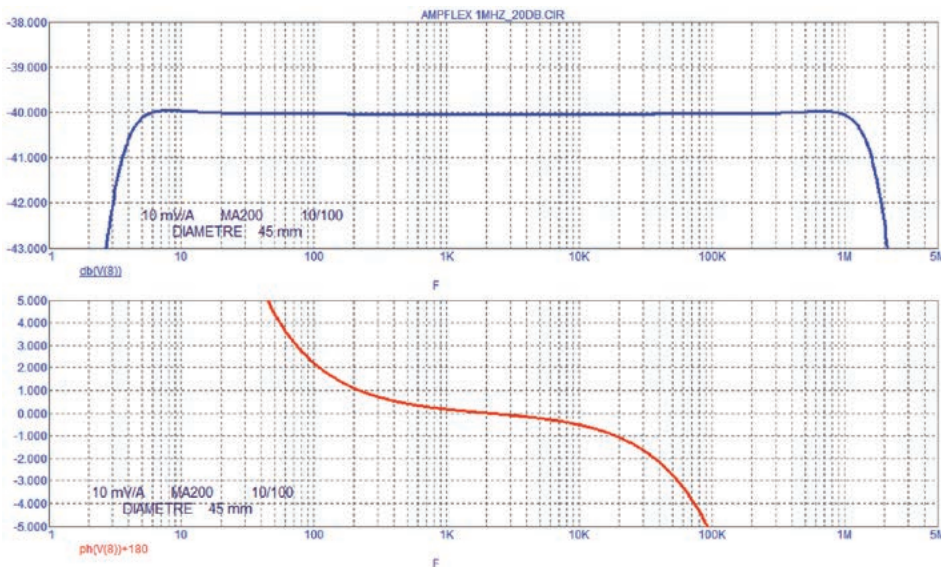

Pulse response

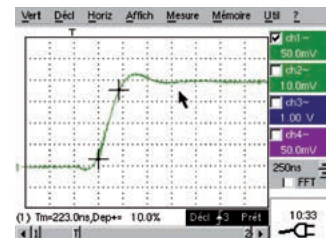

Flexible probe for AC current

MiniFlex® series

Model MA200 30-300/3 (insulated AC current probe)

250 mm LOOP - 30 A CALIBRE

Frequency and phase responses ⁽⁹⁾

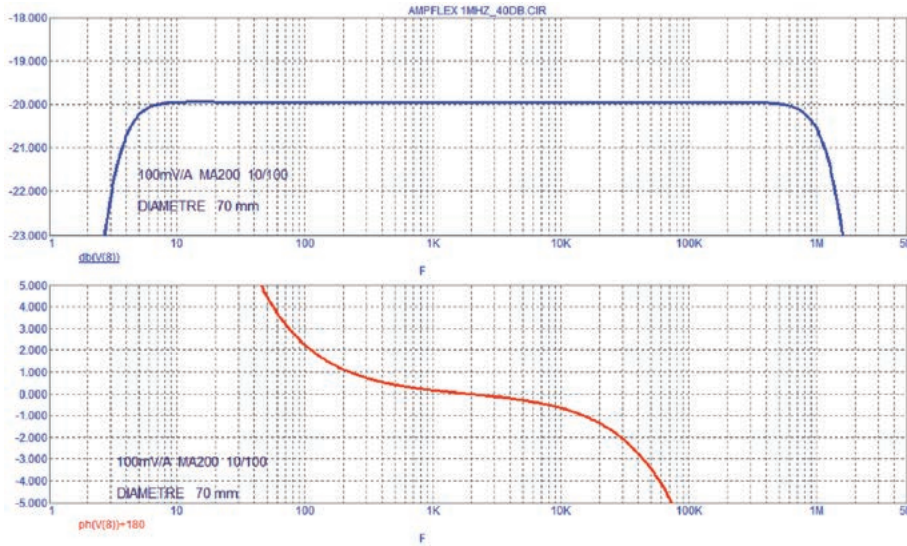

Pulse response

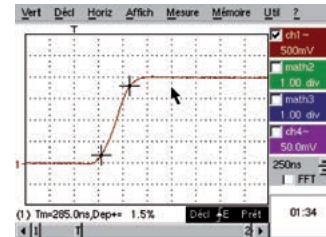

250 mm LOOP - 300 A CALIBRE

Frequency and phase responses ⁽⁹⁾

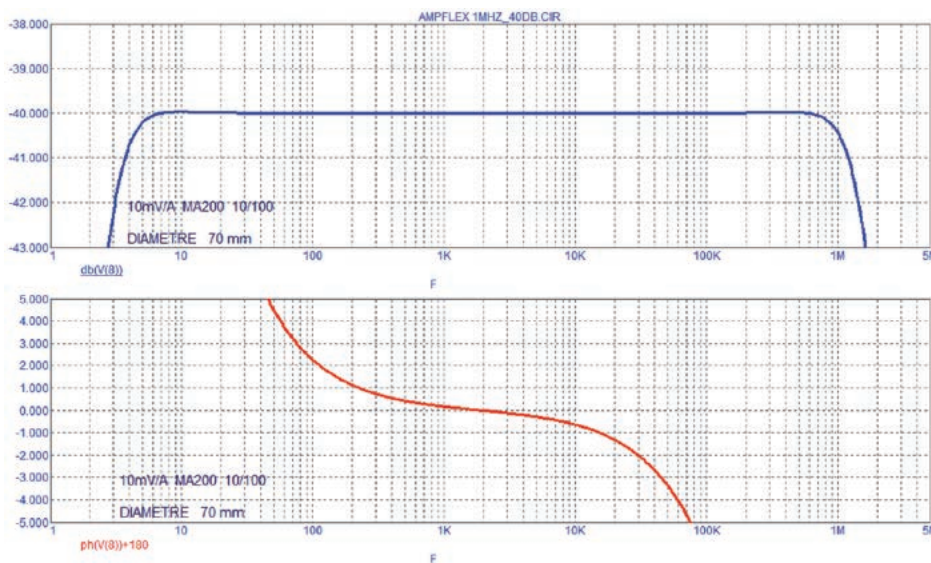

Pulse response

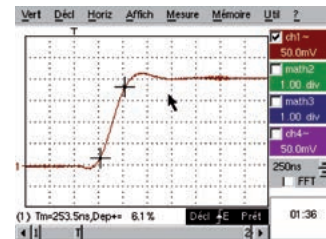

Model MA200 3000/3 (insulated AC current probe)

Current	4500 A peak
Output	1 mV/A

DESCRIPTION

The MiniFlex® MA200 is a flexible sensor comprising an active part (Rogowski coil) linked to a casing containing electronics.

Unlike a current clamp with magnetic circuits, the MiniFlex® models are flexible and are not subject to magnetic saturation constraints, so they offer excellent linearity, low phase shift and a large dynamic range for measurement (up to several kA) while remaining easy to use.

The oscilloscope probes in the MA200 series are specially designed for viewing alternating currents in order to assess the transition and propagation times on electrotechnical equipment.

The sensors' flexibility makes it simple to clamp and measure any conductor, whatever its type (cable, busbar, strand, etc.) and accessibility.

The click-lock system for opening and closing the coil is specially designed for use with safety gloves.

The casing can be connected to any oscilloscope equipped with an AC voltage input.



SPECIFICATIONS FOR CURRENT MEASUREMENT ⁽¹⁾

Calibre	3,000 A
Measurement range in use	0.5 .. 3,000 A AC (4,500 A peak)
Specified measurement range ⁽²⁾	5 .. 3,000 A AC (4,500 A peak)
Output/input ratio	1 mV/A
Accuracy in % of output signal	≤ 1 % + 0.3 A
Phase shift at 1 kHz	≤ 1.5°
Residual current (noise) at I = 0	≤ 0.5 A _{RMS}
Output impedance	1 kΩ

FREQUENCY MEASUREMENT SPECIFICATIONS ⁽¹⁾

Calibre	3,000 A
Bandwidth at -3 dB ⁽⁶⁾	2 Hz .. 1 MHz
Rise time ⁽³⁾ (10 to 90 %)	0.3 μs (typical)
Fall time ⁽⁴⁾ (10 to 90 %)	0.3 μs (typical)
Temps from propagation ⁽⁵⁾ (to 10 %)	0.4 μs (typical)
Insertion impedance at 10 kHz	< 0.05 mΩ

ELECTRICAL SPECIFICATIONS ⁽¹⁾

- **Operating voltage:**
600 V_{RMS} (Cat. IV)
1,000 V_{RMS} (Cat. III)
- **Battery:**
9 V alkaline battery (NEDA 1604A, IEC 6LR61)
- **Battery life:**
100 hours typical
- **Typical consumption:**
3.6 mA typical
- **Battery level indication:**
Green LED when > 7.0 V approx.
- **Influence of battery voltage:**
≤ 0.1 % from 9 V to 7 V
- **Influence of temperature:**
≤ 0.6 % / 10 °K
- **Influence of humidity:**
≤ 0.5 % from 10 % to 90 % RH without condensation
- **Influence of conductor position in the sensor ⁽⁹⁾:**
≤ 2.5 %
- **Influence of sensor deformation ⁽⁷⁾:**
≤ 1 %
- **Influence of an adjacent conductor with circulating AC current ⁽⁸⁾:**
≤ 1.5 % or 36.5 dB
- **Common mode rejection:**
- between enclosure and secondary: ≤ 75 dB
- between sensor and secondary: ≤ 80 dB
- **Influence of the measurement instrument's impedance Z:**
0.1 % / Z (in MΩ)

MECHANICAL SPECIFICATIONS

- **Clamping capacity:**
Model 350 mm: Ø max 100 mm
- **Operating temperature:**
-10 °C to +55 °C
- **Storage temperature:**
-40 °C to +70 °C
- **Max. temperature of clamped conductor (measured):**
≤ 90 °C
- **Relative humidity for operation:**
0 to 85 % RH with a linear decrease above 35 °C
- **Operating altitude:**
0 to 2,000 m
- **Storage altitude:**
≤ 12,000 m
- **Casing protection rating (leakproofing):**
Casing: IP50
Sensor: IP50
According to EN 60529/A1 Ed. 06/2000
- **Shock resistance:**
IK04 according to NF EN 50102 Ed. 1995
- **Self-extinguishing capability:**
Casing: UL94 V2
Sensor: UL94 V0
- **Dimensions:**
Casing: 140 x 64 x 28 mm
Connector lead: 2 m (connects sensor to casing)
Ø of sensor: 5.5 mm approx.
Connection cable Ø: 3 mm approx.

Colours:

Sensor: red
Sensor closing system: dark grey
Sensor locking tab: yellow
Casing: dark grey

Output:

Coaxial cable 40 cm long, terminated by an insulated BNC plug

SAFETY SPECIFICATIONS

Electrical safety:

Class II equipment with double or reinforced insulation between the primary and the secondary (winding connected to the connection cable) as per EN 61010-1 and 61010-2-032:

- 1,000 V Cat. III, pollution degree 2
- 600 V Cat. IV, pollution degree 2

- Type-B sensor

- 600 V Cat. III between the BNC output and the external enclosure of the casing

Electromagnetic compatibility (EMC):

Complies with the IEC 61326 (Ed. 1997) + A1 (Ed. 1998)

- Adequate immunity to disturbances for industrial environments
- Adequate immunity to disturbances for residential environments

- (1) Conditions of reference: 23 °C ± 5 °K, 20 % to 75 % RH
Battery voltage: 9 V ± 0.5 V
Continuous external DC magnetic field (earth field) < 40 A/m
Absence of external AC magnetic field
External electrical field < 1 V/m
Position of conductor measured: centred in the measurement coil
Shape of measurement coil: quasi-circular
Measurement instrument input impedance (oscilloscope) ≥ 1 MΩ
Frequency and form of signal measured: 40 to 400 Hz sinusoidal.
- (2) Measurement range for the specifications indicated in this document.
- (3) Rise Time (t_r)
- (4) Fall Time (t_f)
- (5) Delay Time (t_d)

(6) Frequency limitation according to amplitude

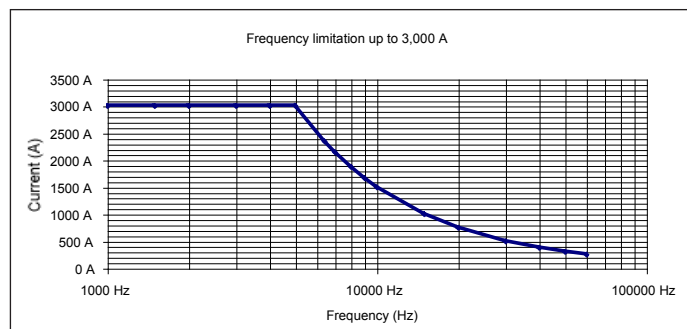

(7) Oblong shape

(8) Adjacent conductor 1 cm from sensor; ≤ 3 % or 30.5 dB near click-lock system

(9) ≤ 6 % near click-lock system

(10) Typical curve obtained by mathematical modelling

To order	Reference
MiniFlex® MA200 3,000 A / 3 V, length 350 mm with operating manual and battery	P01120572

Flexible probe for AC current

MiniFlex® series

Model MA200 3000/3 (insulated AC current probe)

3,000 A CALIBRE

Frequency and phase responses ⁽¹⁰⁾

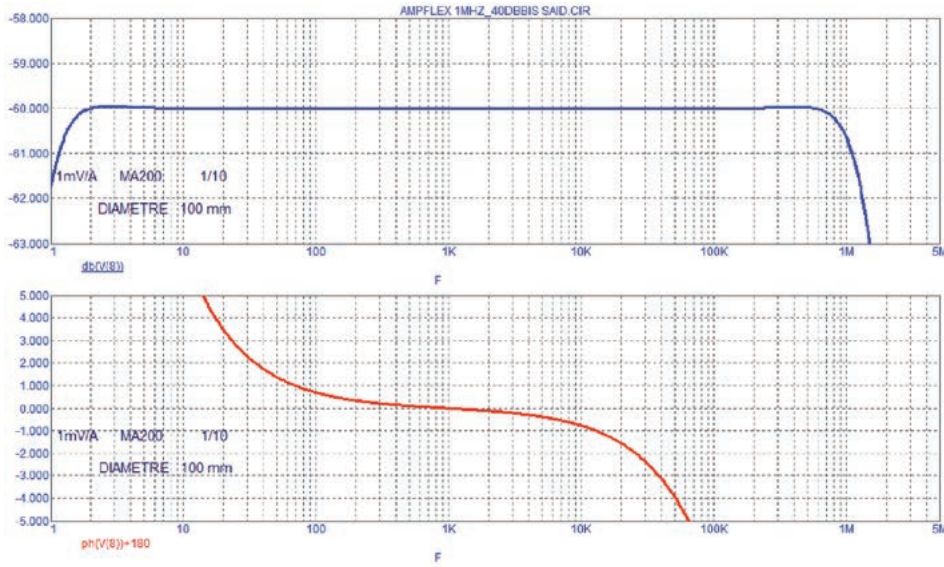

Pulse response

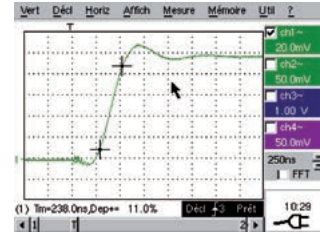

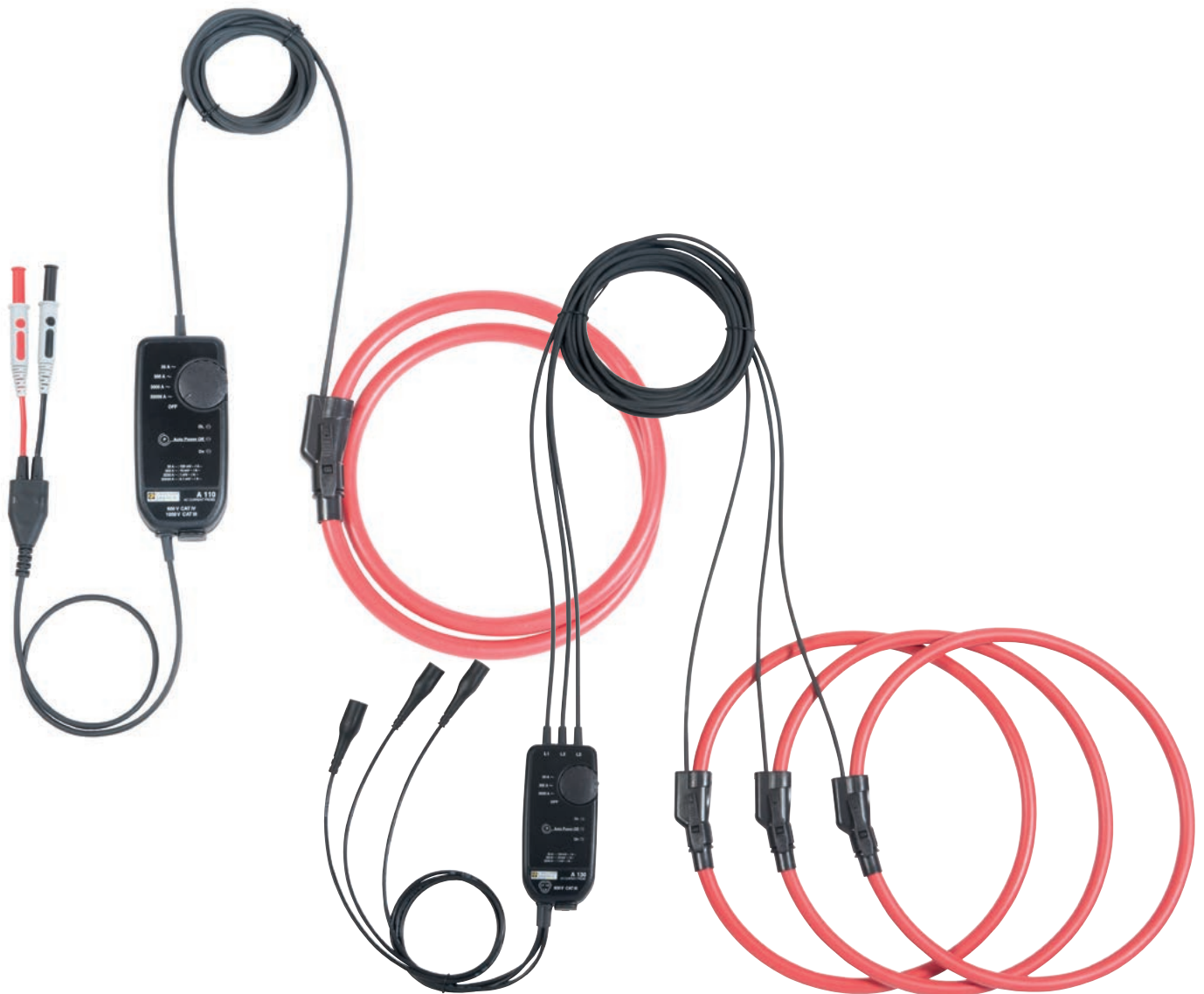

SERIE AmpFlex®

These flexible current probes are as at home measuring low AC currents of a few tens mA as they are measuring high currents of several tens of kA. Their main point of interest is their flexibility and the ease with which electrical conductors of all shapes and sizes (cables, busbars) and degrees of accessibility can be gripped.

They have a number of other advantages; they are lightweight (no magnetic circuit), they do not suffer from the saturation effect and their high level of accuracy combined with minimal phase shift make them perfect for power measurement applications.

• AmpFlex® A110 series:

The sensors in the A110 Series have a flexible core connected by a shielded cable to a small unit containing processing electronics. This IP54 unit offers 4 measurement calibres and can be connected directly to any multimeter, wattmeter or logger. The length of the sensors in this Series (up to 120 cm as standard) enables you to clamp cables with a large cross-section or several conductors simultaneously. The A110 can be used for measurements up to 30 kA AC.

The AmpFlex® A110 offers IP67 ingress protection and can be connected to the AC voltage input (mV AC, V AC) of any multimeter or measuring instrument equipped with Ø 4 mm female banana plugs.

• AmpFlex® A130:

The A130 model is a version of the A110 Series adapted for measurements on three-phase installations. It is equipped with BNC connections. The processing unit offers 3 measurement calibres. The A130 sensor can be connected to the AC voltage inputs (mV AC, V AC) of any power analyser, logger or measuring instrument equipped with BNC plugs.

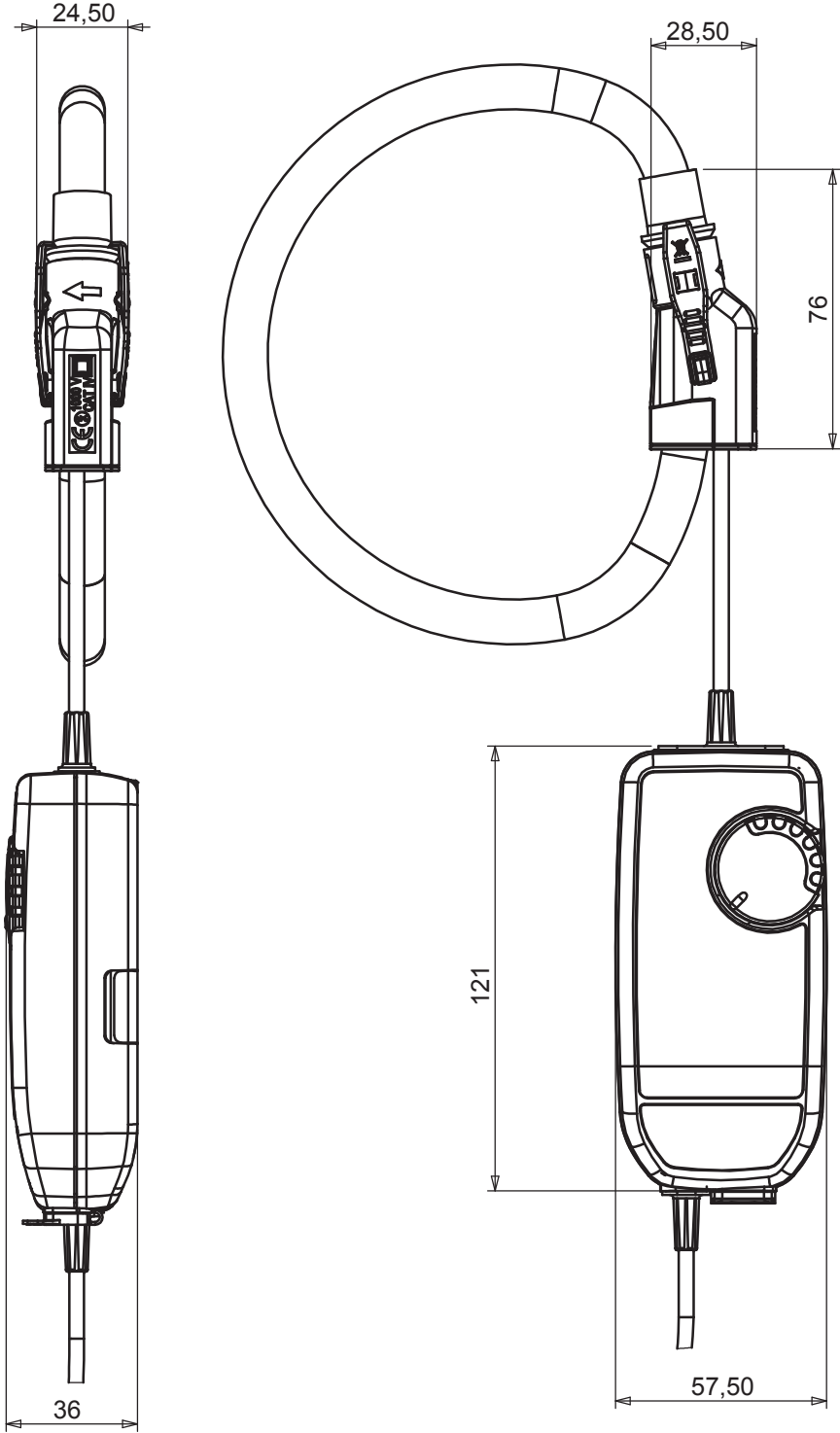

Flexible probe for AC current

Model A110 3-30-300-3000/3

AmpFlex® series



Current	3 A AC	30 A AC	300 A AC	3,000 A AC
Output	1 mV/mA	100 mV/A	10 mV/A	1 mV/A

DESCRIPTION

The AmpFlex® A110 is a flexible sensor which comprises an active part (Rogowski coil) and a casing containing an electronic processing unit. Unlike current clamps using magnetic circuits, the AmpFlex® models are flexible sensors without magnetic saturation constraints. As a result, they offer excellent linearity, low phase shift, a large dynamic range for measurement (up to several kA) while remaining easy to use. The sensors' flexibility makes it easy to clamp the conductor, whatever its type (cable, busbar, strand, etc.) and access conditions.

The design of the click-together opening and closing system means it can be handled with protective gloves.

The AmpFlex® A110 can be connected to the AC voltage input (mV AC, V AC) of any multimeter or measuring instrument equipped with Ø 4 mm female banana plugs.

The AmpFlex® A110 can be powered by batteries or a standard external power supply. If the power supply fails, the instrument's batteries take over.

To maximize the battery life, the MiniFlex® A110 has an automatic standby system which can be deactivated at start-up to perform long-term measurement campaigns. The MiniFlex® A110 has 3 green, yellow and red LEDs indicating, respectively, the power supply status, the status of the automatic standby function and any overruns of the measurement capacity.



SPECIFICATIONS FOR CURRENT MEASUREMENT ⁽¹⁾

Calibre (I _N)	3 A	30 A	300 A	3,000 A
Measurement range in use	0,08 .. 3 A AC	0.5 .. 30 A AC	0.5 .. 300 A AC	0.5 .. 3,000 A AC
Specified measurement range	0.5 .. 3 A AC	2 .. 30 A AC	5 .. 300 A AC	50 .. 3,000 A AC
Output/input ratio	1 V / A	100 mV / A	10 mV / A	1 mV / A
Bandwidth at -3 dB	10 Hz .. 10 kHz	10 Hz .. 20 kHz	10 Hz .. 20 kHz	10 Hz .. 20 kHz
Frequency limitation	Null	Null	Null	See curve XX
Intrinsic uncertainty	≤ 1 %	≤ 1 %	≤ 1.5 % (I < 10 % I _N) ≤ 1 % (I ≥ 10 % I _N)	≤ 1.5 % (I < 10 % I _N) ≤ 1 % (I ≥ 10 % I _N)
Phase shift at 50 Hz	≤ 1° (0.5° typical)	≤ 1° (0.5° typical)	≤ 1° (0.5° typical)	≤ 1° (0.5° typical)

ELECTRICAL SPECIFICATIONS ⁽¹⁾

- Operating voltage:**
1,000 V_{RMS} (Cat. IV)
- Battery:**
2 x 1.5 V batteries (NEDA 15A, IEC LR6, AA)
+5 VDC with a type B micro-USB connector
- Battery life ⁽²⁾:**
300 hours typical
1,800 10-minute approx. measurements
- Consumption:**
10 µA (position OFF)
90 µA (sleep mode)
- Battery level indication:**
Flashing green LED (batteries voltage > 2 V)
- Influence of battery voltage:**
≤ 0.1 % (0.02 % typical) from 3.1 V to 2 V
- Influence of temperature:**
≤ 0.5 % (0.15 % typical) of output signal per 10 °K
- Influence of relative humidity:**
≤ 0.5 % (0.2 % typical) of output signal
- Influence of conductor position in the sensor ⁽³⁾:**
≤ 2.5 % (1 % typical)
- Influence of sensor deformation ⁽⁴⁾:**
≤ 1 % (0.2 % typical)
- Influence of adjacent conductor ⁽⁵⁾:**
≤ I_{ADJ} × 1 % (2 % near click-lock system)
(0.2 % typical)
- Input impedance of the measuring instrument:**
≥ 1 MΩ
- Common mode rejection ⁽⁶⁾:**
≤ 80 dB (100 dB typical)
- Influence of the measurement instrument's impedance Z:**
≤ 0.1 % at 10 kΩ

Flexible probe for AC current

Model A110 3-30-300-3000/3

AmpFlex® series



MECHANICAL SPECIFICATIONS

- **Clamping capacity:**
Model 45 cm: Ø max 7 cm
Model 80 cm: Ø max 12.5 cm
- **Bending radius:**
≥ 40 mm
- **Operating temperature:**
-10 °C to +55 °C
- **Storage temperature:**
-40 °C to +70 °C
- **Max temperature of measured cable:**
90 °C for 10 minutes max.
- **Relative humidity for operation:**
0 to 85 % RH decreasing linearly above 35 °C
- **Operating altitude:**
0 to 2,000 m
- **Casing protection rating (leakproofing):**
Casing: IP54
Flexible sensor: IP 67
According to IEC 60529 Ed. 2.2-2013

- **Drop test:**
1 m
- **Self-extinguishing capability:**
Casing: UL94-V2
Sensor: UL94 V0
- **Dimensions:**
Casing: 120 x 55 x 39 (overall)
Connector lead: 2 m (connects sensor to casing)
Length of output cable: 0.5 m
Ø of sensor: 12 mm
Connection cable Ø: 4 mm
- **Weight:**
Model 45 mm: 450 g
Sensor: 30 g / 10 cm
- **Colours:**
Sensor: red
Click-lock system: dark grey
Casing: dark grey
- **Output:**
Two-wire cable with reinforced or double isolation terminated by 2 red and black Ø 4 mm isolated male banana plugs

SAFETY SPECIFICATIONS

- **Electrical safety:**
Class II equipment with double or reinforced insulation between the primary and the secondary (winding connected to the connection cable) as per EN 61010-1 and 61010-2-032 Ed. 03-2012:
Sensor:
- Type B
- 1,000 V Cat. IV pollution degree 2
Casing:
- 600 V Cat. III between the terminals and the external enclosure of the casing
- **Electromagnetic compatibility (EMC):**
Complies with the industrial environments according to EN 61326-1 Ed. 02-2012:
- Immunity to radiated fields: at 3 V/m, error ≤ 5 % of measurement range (criterion A)

- (1) Conditions of reference: 23 °C ± 5 °K, 20 % to 75 % RH
Battery voltage 3.2 V ± 0.1 VDC
Frequency and form of signal measured: 30 to 440 Hz sinusoidal
Continuous magnetic field < 40 A/m
Absence of external AC magnetic field
Absence of external electrical field
Measured conductor centred in the circular sensor (coil) after operation for 1 minute
Measurement instrument input impedance ≥ 1 MΩ
- (2) With 3,000 mA/h batteries, for a supplied voltage between 3.2 V and 1.8 V (1.6 V to 0.9 V per battery), giving an average voltage of 2.8 V
- (3) Whatever the conductor's position within the loop, as long as the sensor is not distorted (circular sensor)
- (4) Oblong shape
- (5) Adjacent conductor carrying an AC current I_{adj} , in contact with the sensor
- (6) For a 600 V voltage applied between the enclosure and the secondary

3,000 A calibre

Limitation of current measured according to frequency

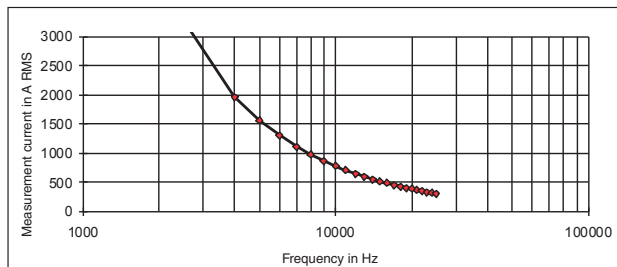

To order	Reference
AmpFlex® A110 3-30-300-3,000 A / 3 V , length 45 cm Output via cable terminated by 2 x Ø 4 mm isolated male banana plugs	P01120630
AmpFlex® A110 3-30-300-3,000 A / 3 V , length 80 cm Output via cable terminated by 2 x Ø 4 mm isolated male banana plugs	P01120631

Flexible probe for AC current

Model A110 3-30-300-3000/3

AmpFlex® series



FREQUENCY RESPONSE

Calibre 3 A

Typical error on measurement according to frequency for a current of 2 A

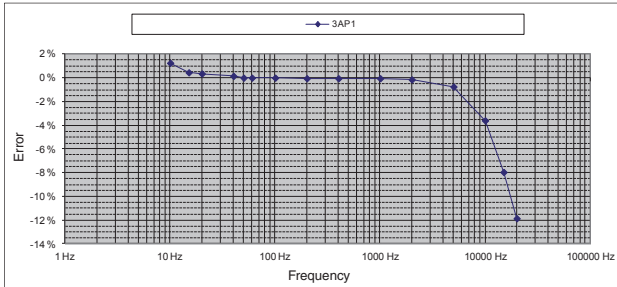

30 A calibre

Typical error on measurement according to frequency for a current of 20 A

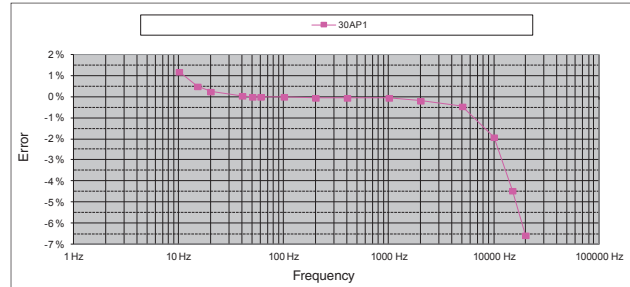

Typical phase shift according to frequency for a current of 2 A

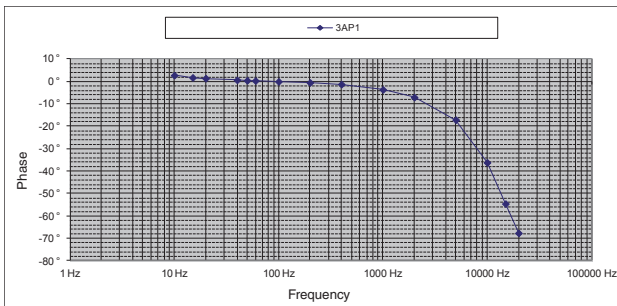

Typical phase shift according to frequency for a current of 20 A

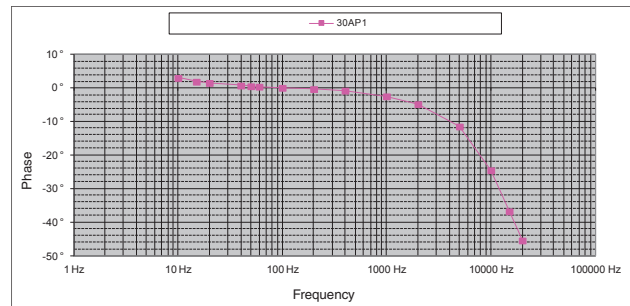

300 A calibre

Typical error on measurement according to frequency for a current of 20 A

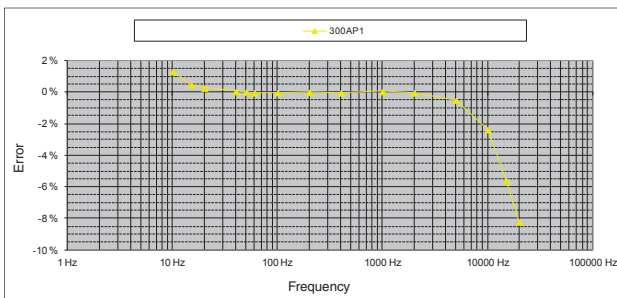

3,000 A calibre

Typical error on measurement according to frequency for a current of 20 A

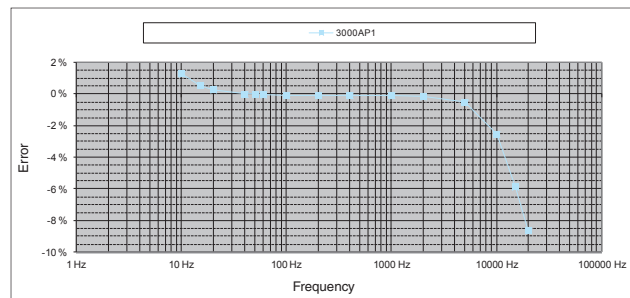

Typical phase shift according to frequency for a current of 20 A

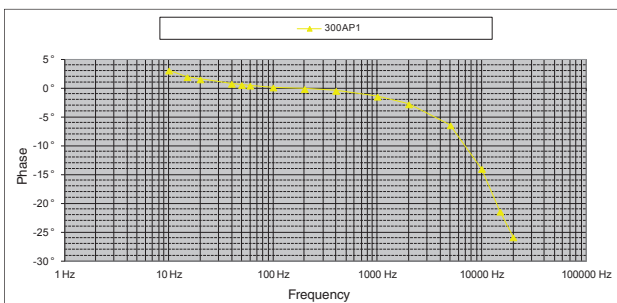

Typical phase shift according to frequency for a current of 20 A

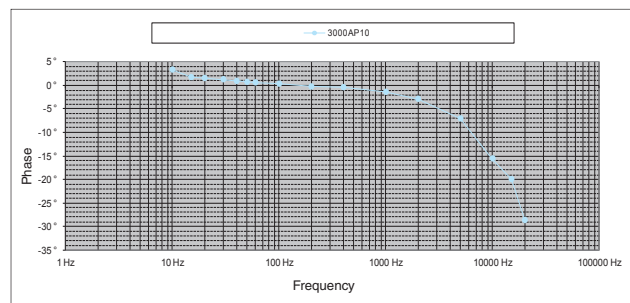

Current	30 A AC	300 A AC	3,000 A AC	30,000 A AC
Output	100 mV/A	10 mV/A	1 mV/A	0.1 mV/A

DESCRIPTION

The AmpFlex® A110 is a flexible sensor which comprises an active part (Rogowski coil) and a casing containing an electronic processing unit. Unlike current clamps using magnetic circuits, the AmpFlex® models are flexible sensors without magnetic saturation constraints. As a result, they offer excellent linearity, low phase shift, a large dynamic range for measurement (up to several kA) while remaining easy to use. The sensors' flexibility makes it easy to clamp the conductor, whatever its type (cable, busbar, strand, etc.) and access conditions.

The design of the click-together opening and closing system means it can be handled with protective gloves.

The AmpFlex® A110 can be connected to the AC voltage input (mV AC, V AC) of any multimeter or measuring instrument equipped with Ø 4 mm female banana plugs.

The AmpFlex® A110 can be powered by batteries or a standard external power supply. If the power supply fails, the instrument's batteries take over.

To maximize the battery life, the MiniFlex® A110 has an automatic standby system which can be deactivated at start-up to perform long-term measurement campaigns.

The MiniFlex® A110 has 3 green, yellow and red LEDs indicating, respectively, the power supply status, the status of the automatic standby function and any overruns of the measurement capacity.



SPECIFICATIONS FOR CURRENT MEASUREMENT ⁽¹⁾

Calibre (I _N)	30 A	300 A	3,000 A	30,000 A
Measurement range in use	0.5 .. 30 A AC	0.5 .. 300 A AC	0.5 .. 3,000 A AC	0.5 .. 30,000 A AC
Specified measurement range	0.5 .. 30 A AC	10 .. 300 A AC	10 .. 3,000 A AC	50 .. 30,000 A AC
Output/input ratio	100 mV / A	10 mV / A	1 mV / A	0.1 mV / A
Bandwidth at -3 dB	10 Hz .. 10 kHz	10 Hz .. 10 kHz	10 Hz .. 20 kHz	10 Hz .. 20 kHz
Frequency limitation	Null	Null	Null	See curve
Intrinsic uncertainty	≤ 1 %	≤ 1 %	≤ 1.5 % (I < 10 % I _N) ≤ 1 % (I ≥ 10 % I _N)	≤ 1.5 % (I < 10 % I _N) ≤ 1 % (I ≥ 10 % I _N)
Phase shift at 50 Hz	≤ 1° (0.5° typical)	≤ 1° (0.5° typical)	≤ 1° (0.5° typical)	≤ 1° (0.5° typical)

ELECTRICAL SPECIFICATIONS ⁽¹⁾

- Operating voltage:**
1,000 V_{RMS} (Cat. IV)
- Battery:**
Two 1.5 V batteries (NEDA 15A, IEC LR6, AA)
+5 VDC with a type B micro-USB connector
- Battery life ⁽²⁾:**
300 hours typical
1,800 10-minute approx. measurements
- Consumption:**
10 µA (position OFF)
90 µA (sleep mode)
- Battery level indication:**
Flashing green LED (batteries voltage > 2 V)
- Influence of battery voltage:**
≤ 0.1 % (0.02 % typical) from 3.1 V to 2 V
- Influence of temperature:**
≤ 0.5 % (0.15 % typical) of output signal per 10 °K
- Influence of relative humidity:**
≤ 0.5 % (0.2 % typical) of output signal
- Influence of conductor position in the sensor ⁽³⁾:**
≤ 2.5 % (1 % typical)
- Influence of sensor deformation ⁽⁴⁾:**
≤ 1 % (0.2 % typical)
- Influence of adjacent conductor ⁽⁵⁾:**
≤ I_{ADJ} × 1 % (2 % near click-lock system)
(0.2 % typical)
- Input impedance of the measuring instrument:**
≥ 1 MΩ
- Common mode rejection ⁽⁶⁾:**
≤ 80 dB (100 dB typical)
- Influence of the measurement instrument's impedance Z:**
≤ 0.1 % at 10 kΩ

MECHANICAL SPECIFICATIONS

- Clamping capacity:**
Model 120 mm: Ø max 19 cm
- Bending radius:**
≥ 40 mm
- Operating temperature:**
-10 °C to +55 °C
- Storage temperature:**
-40 °C to +70 °C
- Max temperature of measured cable:**
90 °C for 10 minutes max.
- Relative humidity for operation:**
0 to 85 % RH decreasing linearly above 35 °C
- Operating altitude:**
0 to 2,000 m
- Casing protection rating (leakproofing):**
Casing: IP54
Flexible sensor: IP 67
According to IEC 60529 Ed. 2.2-2013
- Drop test:**
1 m

- Self-extinguishing capability:**

Casing: UL94-V2
Sensor: UL94 V0

- Dimensions:**

Casing: 120 x 55 x 39 (overall)
Connector lead: 2 m (connects sensor to casing)
Length of output cable: 0.5 m
Ø of sensor: 12 mm
Connection cable Ø: 4 mm

- Weight:**

Model 45 mm: 450 g
Sensor: 30 g / 10 cm

- Colours:**

Sensor: red
Click-lock system: dark grey
Casing: dark grey

- Output:**

Two-wire cable with reinforced or double isolation terminated by 2 red and black Ø 4 mm isolated male banana plugs

SAFETY SPECIFICATIONS

- Electrical safety:**

Class II equipment with double or reinforced insulation between the primary and the secondary (winding connected to the connection cable) as per EN 61010-1 and 61010-2-032 Ed. 03-2012:

Sensor:

- Type B
- 1,000 V Cat. IV pollution degree 2

Casing:

- 600 V Cat. III between the terminals and the external enclosure of the casing

- Electromagnetic compatibility (EMC):**

Complies with the industrial environments according to EN 61326-1 Ed. 02-2012:

- Immunity to radiated fields: at 3 V/m, error ≤ 5 % of measurement range (criterion A)

(1) Conditions of reference: 23 °C ± 5 °K, 20 % to 75 % RH

Battery voltage 3.2 V ± 0.1 VDC

Frequency and form of signal measured: 30 to 440 Hz sinusoidal

Continuous magnetic field < 40 A/m

Absence of external AC magnetic field

Absence of external electrical field

Measured conductor centred in the circular sensor (coil) after operation for 1 minute

Measurement instrument input impedance ≥ 1 MΩ

(2) With 3,000 mA/h batteries, for a supplied voltage between 3.2 V and 1.8 V (1.6 V to 0.9 V per battery), giving an average voltage of 2.8 V

(3) Whatever the conductor's position within the loop, as long as the sensor is not distorted (circular sensor)

(4) Oblong shape

(5) Adjacent conductor carrying an AC current I_{adj} , in contact with the sensor

(6) For a 600 V voltage applied between the enclosure and the secondary

3,000 A calibre

Limitation of current measured according to frequency

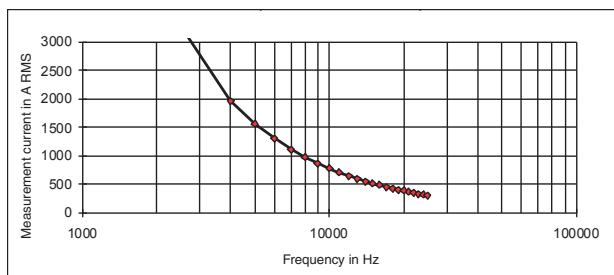

30,000 A calibre

Limitation of current measured according to frequency

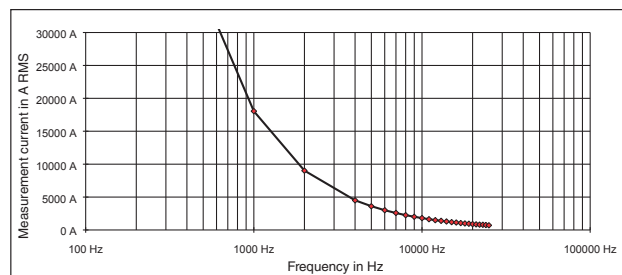

To order	Reference
AmpFlex® A110 30-300-3k-30k A / 3 V, length 120 cm Output via cable terminated by 2 x Ø 4 mm isolated male banana plugs	P01120632

Flexible probe for AC current

Model A110 30-300-3000-30000/3

AmpFlex® series



FREQUENCY RESPONSE

30 A calibre

Typical error on measurement according to frequency for a current of 2 A

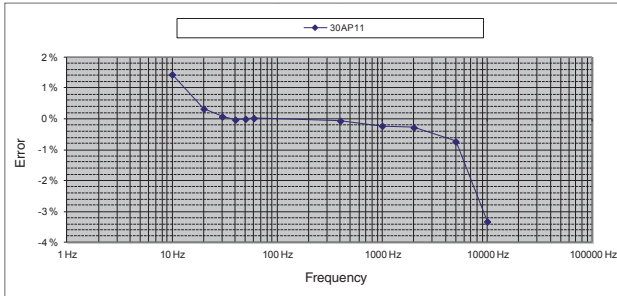

300 A calibre

Typical error on measurement according to frequency for a current of 20 A

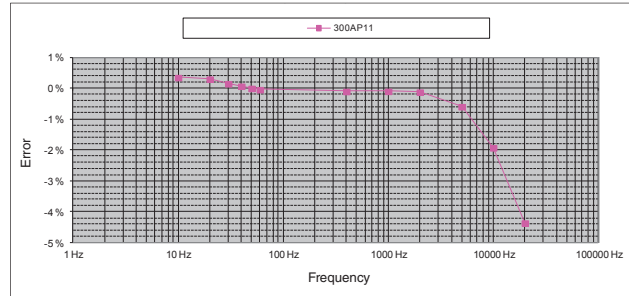

Typical phase shift according to frequency for a current of 20 A

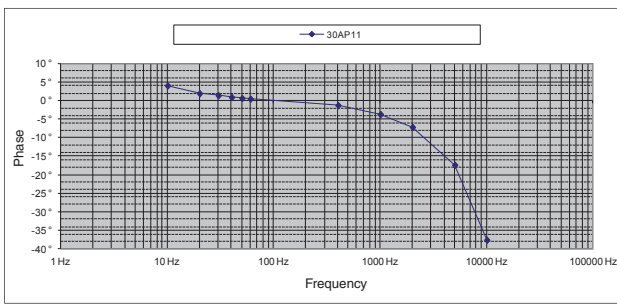

Typical phase shift according to frequency for a current of 20 A

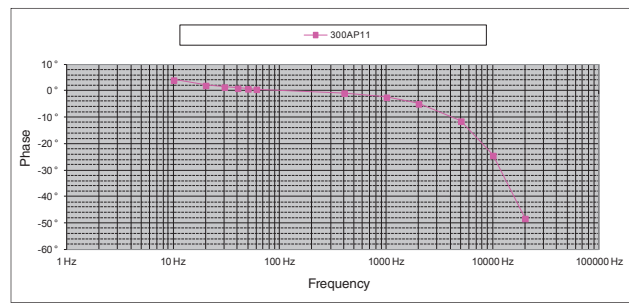

3,000 A calibre

Typical error on measurement according to frequency for a current of 20 A

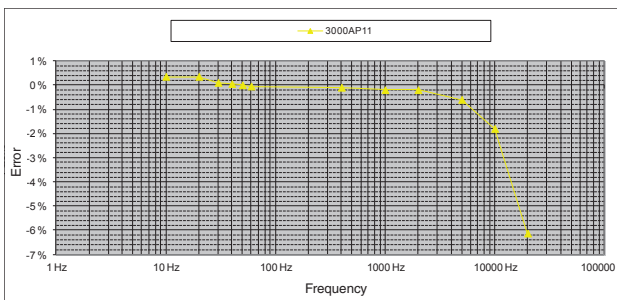

30,000 A calibre

Typical error on measurement according to frequency for a current of 20 A

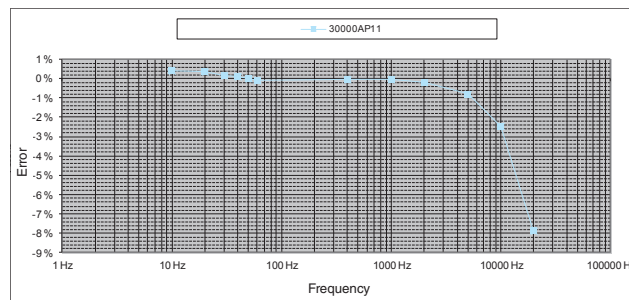

Typical phase shift according to frequency for a current of 20 A

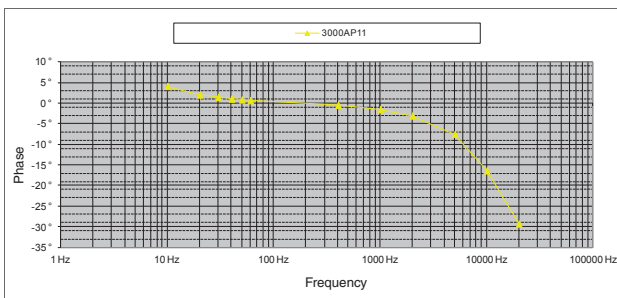

Typical phase shift according to frequency for a current of 20 A

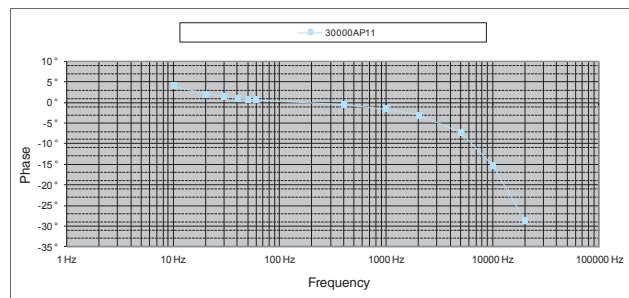

Flexible probe for AC current

Model A110 on request

AmpFlex® series



CONFIGURATIONS

Level 1

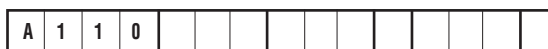

1 Category

2 Lead length in centimeters

Min value : **050** (50 cm)
 Max value : **995** (9.95 m)
 Increment per 5 cm section

3 Length of connection lead in centimeters

Min value : **050** (50 cm)
 Max value : **995** (9.95 m)
 Increment per 5 cm section

4 Output via

- A:** coaxial cable of the length to be defined in **5** terminated by a 600 V CAT III isolated male BNC socket
- B:** cable 50 cm long terminated by 2 red/black Ø 4 mm isolated male banana plugs rated 600 V CAT IV
- C:** shielded cable with 2 bared, tin-plated conductors of the length to be defined in **5**, rated 600 V CAT IV

5 Output cable length in cm

If **4** = "A"

Min value : **050** (50 cm)
 Max value : **110** (1.10 m)
 Increment per 5 cm section

If **4** = "C"

Min value : **050** (50 cm)
 Max value : **995** (9.95 m)
 Increment per 5 cm section

6 Measurement calibres (sensitivities)

- A:** 3 A-30 A-300 A -3000 A/3 V (1 V-100 mV-10 mV-1 mV/A)
- B:** 30 A-300 A -3,000 A-30,000 A / 3 V (100 mV-10 mV-1 mV-0.1 mV / A)

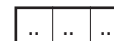
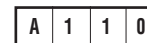

On request - Modulo 5 cm
 Coding over 3 characters
 E.g. 50 cm = 050; 9 m = 900

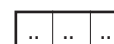

On request - Modulo 5 cm
 Coding over 3 characters
 E.g. 50 cm = 050; 9 m = 900

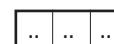

On request - Modulo 5 cm
 Coding over 3 characters
 E.g. 50 cm = 050; 1 m = 100



Reference: (products available in stock)	Codes
	P01120631
	P01120632

Model A130 30-300-3000/3 Three-phase

Current	30 A AC	300 A AC	3,000 A AC
Output	100 mV/A	10 mV/A	1 mV/A

DESCRIPTION

The AmpFlex® A130 is a flexible sensor which comprises an active part (Rogowski coil) and a casing containing an electronic processing unit. Unlike current clamps using magnetic circuits, the AmpFlex® models are flexible sensors without magnetic saturation constraints. As a result, they offer excellent linearity, low phase shift, a large dynamic range for measurement (up to several kA) while remaining easy to use. The sensors' flexibility makes it easy to clamp the conductor, whatever its type (cable, busbar, strand, etc.) and access conditions.

The design of the click-together opening and closing system means it can be handled with protective gloves.

The AmpFlex® A130 can be connected to the AC voltage input (mV AC, V AC) of any multimeter or measuring instrument equipped with Ø 4 mm female banana plugs.

The AmpFlex® A130 can be powered by batteries or a standard external power supply. If the power supply fails, the instrument's batteries take over. To maximize the battery life, the MiniFlex® A130 has an automatic standby system which can be deactivated at start-up to perform long-term measurement campaigns.

The MiniFlex® A130 has 3 green, yellow and red LEDs indicating, respectively, the power supply status, the status of the automatic standby function and any overruns of the measurement capacity.



SPECIFICATIONS FOR CURRENT MEASUREMENT ⁽¹⁾

Calibre (I _N)	30 A	300 A	3,000 A
Measurement range in use	0.5 .. 30 A AC	0.5 .. 300 A AC	0.5 .. 3,000 A AC
Specified measurement range	5 .. 30 A AC	5 .. 300 A AC	50 .. 3,000 A AC
Output/input ratio	100 mV / A	10 mV / A	1 mV / A
Bandwidth at -3 dB	10 Hz .. 20 kHz	10 Hz .. 20 kHz	10 Hz .. 20 kHz
Frequency limitation	Null	Null	See curve
Intrinsic uncertainty	≤ 1 % + 4 mV	≤ 1.5 % (I < 10 % I _N) ≤ 1 % (I ≥ 10 % I _N)	≤ 1.5 % (I < 10 % I _N) ≤ 1 % (I ≥ 10 % I _N)
Phase shift at 50 Hz	≤ 1° (0.5° typical)	≤ 1° (0.5° typical)	≤ 1° (0.5° typical)

ELECTRICAL SPECIFICATIONS ⁽¹⁾

- Operating voltage:**
1,000 V_{RMS} (Cat. IV)
- Battery:**
Two 1.5 V batteries (NEDA 15A, IEC LR6, AA)
+5 VDC with a type B micro-USB connector
- Battery life ⁽²⁾:**
500 hours typical
3,000 10-minute approx. measurements
- Consumption:**
10 µA (position OFF)
90 µA (sleep mode)
- Battery level indication:**
Flashing green LED (batteries voltage > 2 V)
- Influence of battery voltage:**
≤ 0.1 % (0.02 % typical) from 3.1 V to 2 V
- Influence of temperature:**
≤ 0.5 % (0.15 % typical) of output signal per 10 °K
- Influence of relative humidity:**
≤ 0.5 % (0.2 % typical) of output signal
- Influence of conductor position in the sensor ⁽³⁾:**
≤ 2.5 % (1 % typical)
- Influence of sensor deformation ⁽⁴⁾:**
≤ 1 % (0.2 % typical)
- Influence of adjacent conductor ⁽⁵⁾:**
≤ I_{ADJ} × 1 % (2 % near click-lock system)
(0.2 % typical)
- Input impedance of the measuring instrument:**
≥ 1 MΩ
- Common mode rejection ⁽⁶⁾:**
≤ 80 dB (100 dB typical)
- Influence of the measurement instrument's impedance Z:**
≤ 0.1 % at 10 kΩ

MECHANICAL SPECIFICATIONS

- **Clamping capacity:**
Model 80 mm: Ø max 12.5 mm
- **Bending radius:**
≥ 40 mm
- **Operating temperature:**
-10 °C to +55 °C
- **Storage temperature:**
-40 °C to +70 °C
- **Max temperature of measured cable:**
90 °C for 10 minutes max.
- **Relative humidity for operation:**
0 to 85 % RH decreasing linearly above 35 °C
- **Operating altitude:**
0 to 2,000 m
- **Casing protection rating (leakproofing):**
Casing: IP54
Flexible sensor: IP 67
According to IEC 60529 Ed. 2.2-2013

- **Drop test:**
1 m (IEC 68-2-32)
- **Self-extinguishing capability:**
Casing: UL94-V2
Sensor: UL94 V0
- **Dimensions:**
Casing: 120 x 55 x 39 (overall)
Connector lead: 3 m (connects sensor to casing)
Length of output cable: 0.5 m
Ø of sensor: 12 mm
Connection cable Ø: 4 mm
- **Weight:**
1 kg
- **Colours:**
Sensor: red
Click-lock system: dark grey
Casing: dark grey
- **Output:**
3 coaxial cables with reinforced or double isolation terminated by 1 black isolated male BNC plug

SAFETY SPECIFICATIONS

- **Electrical safety:**
Class II equipment with double or reinforced insulation between the primary and the secondary (winding connected to the connection cable) as per EN 61010-1 and 61010-2-032 Ed. 03-2012:
Sensor:
- Type B
- 1,000 V Cat. IV pollution degree 2
Casing:
- 600 V Cat. III between the terminals and the external enclosure of the casing
- **Electromagnetic compatibility (EMC):**
Complies with the industrial environments according to EN 61326-1 Ed. 02-2012:
- Immunity to radiated fields: at 3 V/m, error ≤ 5 % of measurement range (criterion A)

- (1) Conditions of reference: 23 °C ± 5 °K, 20 % to 75 % RH
Battery voltage 3.2 V ± 0.1 VDC
Frequency and form of signal measured: 30 to 440 Hz sinusoidal
Continuous magnetic field < 40 A/m
Absence of external AC magnetic field
Absence of external electrical field
Measured conductor centred in the circular sensor (coil) after operation for 1 minute
Measurement instrument input impedance ≥ 1 MΩ
- (2) With 3,000 mA/h batteries, for a supplied voltage between 3.2 V and 1.8 V (1.6 V to 0.9 V per battery), giving an average voltage of 2.8 V
- (3) Whatever the conductor's position within the loop, as long as the sensor is not distorted (circular sensor)
- (4) Oblong shape
- (5) Adjacent conductor carrying an AC current I_{adj} , in contact with the sensor
- (6) For a 600 V voltage applied between the enclosure and the secondary
- (7) Delivered with a set of 3 female BNC/ Ø 4 mm isolated male banana adapters with 19 mm spacing and a set of identifiers (12 colours)

3,000 A calibre

Limitation of current measured according to frequency

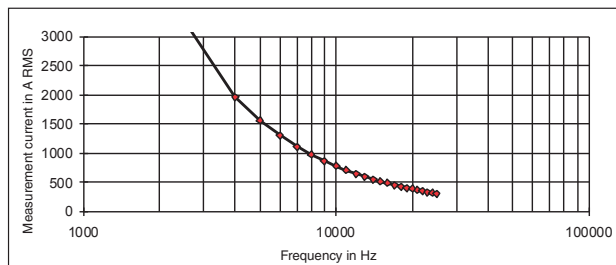

To order	Reference
AmpFlex® A130 30-300-3,000 A / 3 V, length 80 cm Output via 3 coaxial cables terminated by 1 isolated male BNC plug	P01120633

Flexible probe for AC current

Model A130 30-300-3000/3 Three-phase

AmpFlex® series



FREQUENCY RESPONSE

30 A calibre

Typical error on measurement according to frequency for a current of 20 A

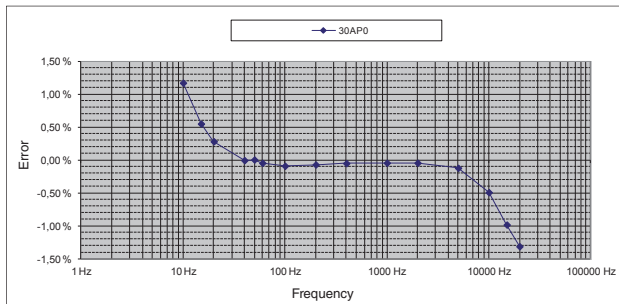

Typical phase shift according to frequency for a current of 20 A

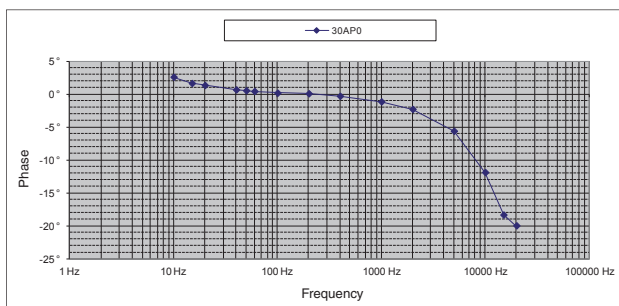

300 A calibre

Typical error on measurement according to frequency for a current of 20 A

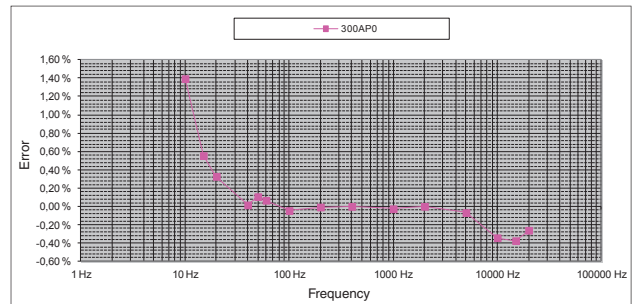

Typical phase shift according to frequency for a current of 20 A

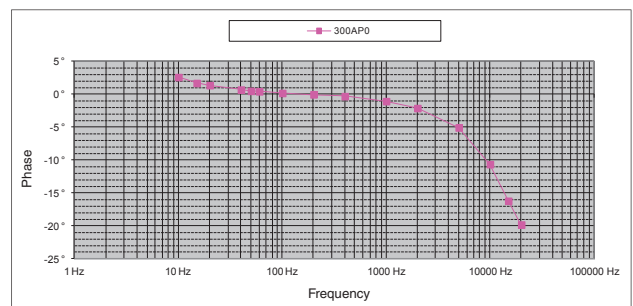

3,000 A calibre

Typical error on measurement according to frequency for a current of 20 A

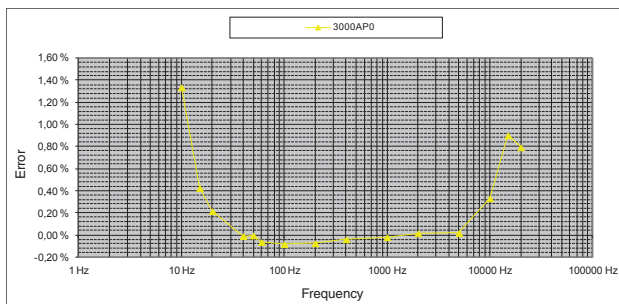

Typical phase shift according to frequency for a current of 20 A

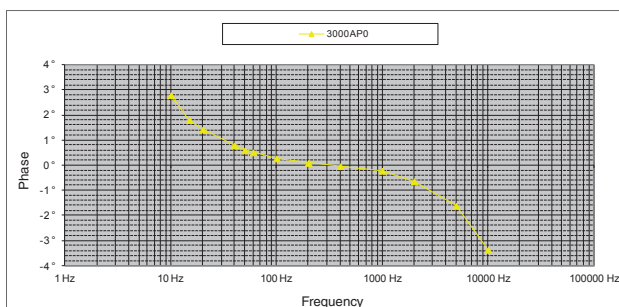

CONFIGURATIONS

Level 1

A	1	3	0																
---	---	---	---	--	--	--	--	--	--	--	--	--	--	--	--	--	--	--	--

1 Category

2 Lead length in centimeters

Min value : **050** (50 cm)
 Max value : **995** (9.95 m)
 Increment per 5 cm section

3 Length of connection lead in centimeters

Min value : **050** (50 cm)
 Max value : **995** (9.95 m)
 Increment per 5 cm section

4 Output via

- A:** coaxial cable of the length to be defined in **5** terminated by a 600 V CAT III isolated male BNC socket
- B:** cable 50 cm long terminated by 2 red/black Ø 4 mm isolated male banana plugs rated 600 V CAT III
- C:** shielded cable with 2 bared, tin-plated conductors of the length to be defined in **5**, rated 600 V CAT III

5 Output cable length in cm

If **4** = "A"

Min value : **050** (50 cm)
 Max value : **110** (1.10 m)
 Increment per 5 cm section

If **4** = "C"

Min value : **050** (50 cm)
 Max value : **995** (9.95 m)
 Increment per 5 cm section

A	1	3	0
---	---	---	---

..
----	----	----

On request - Modulo 5 cm
 Coding over 3 characters
 E.g. 50 cm = 050; 9 m = 900

..
----	----	----

On request - Modulo 5 cm
 Coding over 3 characters
 E.g. 50 cm = 050; 9 m = 900

..

..
----	----	----

On request - Modulo 5 cm
 Coding over 3 characters
 E.g. 50 cm = 050; 1.10 m = 110

Reference: (products available in stock)	Codes														
<table border="1"> <tr> <td>A</td><td>1</td><td>3</td><td>0</td><td>0</td><td>8</td><td>0</td><td>3</td><td>0</td><td>0</td><td>A</td><td>0</td><td>5</td><td>0</td> </tr> </table>	A	1	3	0	0	8	0	3	0	0	A	0	5	0	P01120633
A	1	3	0	0	8	0	3	0	0	A	0	5	0		



K SERIES

The K series is a new product range with exceptional measurement capabilities.

Extremely compact in design, these "micro-probes" are designed for highly accurate measurement of very low currents.

Their small dimensions and shape make them ideal for probing into tight spaces where access is limited, as is the case on most switchboards, 4-20 A process loops or vehicle wiring looms for example.

These "K" series current probes make excellent work companions for multimeters and any other instrument able to make use of their high sensitivity, dynamic range and ability to indicate the shapes of signals and waveforms.

They give an AC+DC output signal that is proportional to the measured current, without needing to change the range or filter the signal. RMS measurements are possible with DC+AC components.

There are two different types of K series current probes available.

Model K1 gives a 1 mV/mA output and lends itself to a variety of different applications, oriented towards low-current measurement.

Model K2 has a greater level of sensitivity with its 10 mV/mA output.

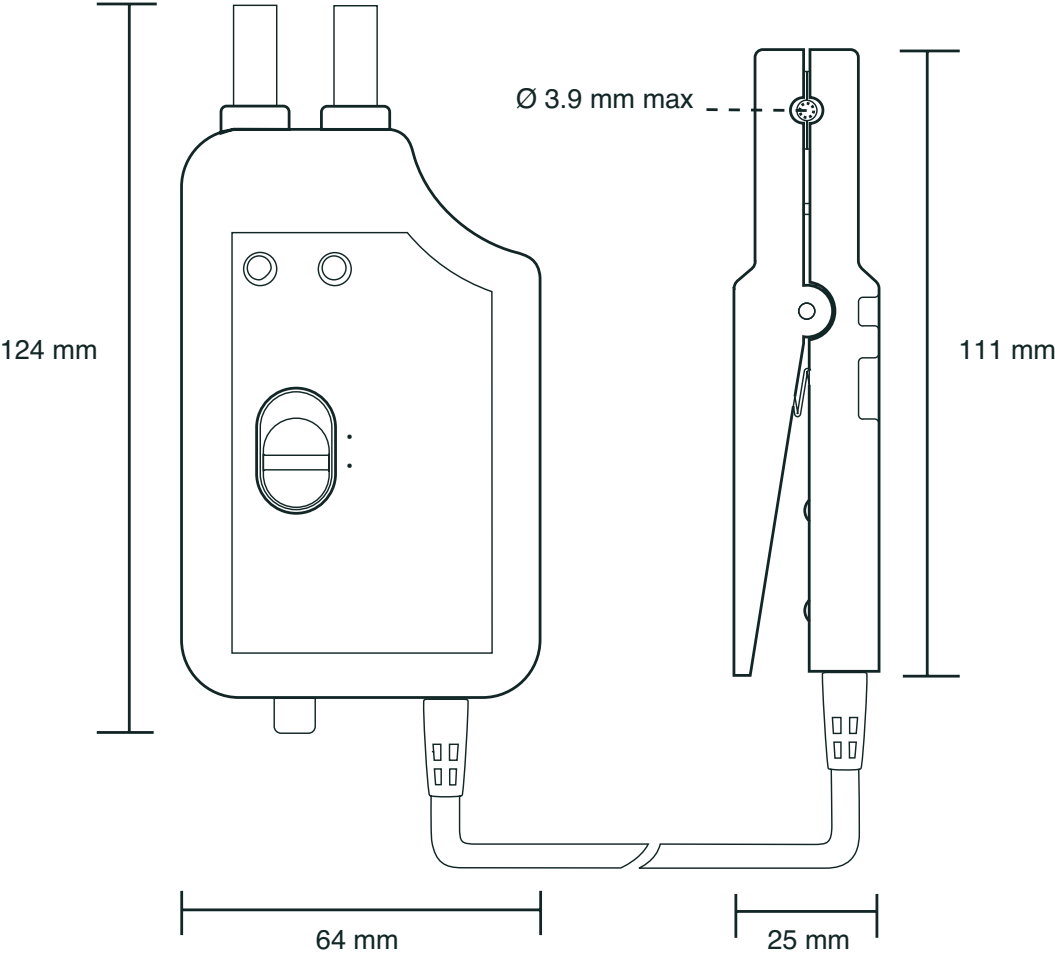

Model K1

Current	4500 mA DC 3000 mA AC
Output	1 mV/mA

DESCRIPTION

The K1 model measures currents as low as 100 μ A AC or DC. The clamp provides a proportional output signal enabling direct readings on multimeters.

ELECTRICAL SPECIFICATIONS

- Current calibres:**
 - 1 mA DC .. \pm 4.5 A DC
 - 1 mA RMS .. 3 A RMS (sinusoidal)
 - 1 mA .. 4.5 A peak, square and steps
- Output (output voltage):** 1 mV/mA
- Resolution:**
 - DC: 50 μ A typical
 - AC: 100 μ A typical
- Accuracy ⁽¹⁾:**
 - DC current

Primary current	1 mA .. 10 mA	10 mA .. 120 mA	120 mA .. 4500 mA
% Accuracy of output signal	2% \pm 0.2 mV	2% \pm 0.1 mV	1%

- AC current from 45 Hz to 65 Hz

Primary current	1 mA .. 10 mA	10 mA .. 120 mA	120 mA .. 3000 mA
% Accuracy of output signal	3% \pm 0.3 mV	3% \pm 0.1 mV	1%

- Frequency response:** DC to 2 kHz (at -3 dB)
- Load impedance:** \geq 1 M Ω and \leq 100 pF
- Output noise:** < 100 μ V, DC to 3 kHz
- Output impedance:** 220 Ω
- Inductance of clamp:** < 1 μ H
- Rise time:** < 200 μ s, 10% at 90%
- Fall time:** < 200 μ s, 90% at 10%
- Influence of adjacent conductors:** (50 Hz at 23 mm from the clamp): < 100 μ A/A
- Influence of earth field:** < 120 μ A
- Battery:** Alkaline 9 V, NEDA 1604, 6LR61 or IEC 6 LF22
- Low battery signal:** Green LED when battery voltage > 6.5 V
- Battery charge life:** Approximately 20 hours

- Overload indication:** Red LED indicating momentary or continuous overload
- Max. current:** 200 A AC or DC with current limitation according to with frequency, above 400 Hz

MECHANICAL SPECIFICATIONS

- Operating temperature:** -10 $^{\circ}$ C to +55 $^{\circ}$ C
- Storage temperature:** -40 $^{\circ}$ C to +80 $^{\circ}$ C
- Influence of temperature:** < 1,000 ppm/ $^{\circ}$ K or 1% /10 $^{\circ}$ C
- Humidity:** < 95% for < 35 $^{\circ}$ C, 75% at +55 $^{\circ}$ C
- Operating altitude:** 0 to 2,000 m
- Adjustment of DC zero:** approximately \pm 25 mA by turning the button on the bottom of the housing
- Max. jaw insertion capacity:** \varnothing 3.9 mm
- Protection rating:** Casing: IP 40 in accordance with IEC 529

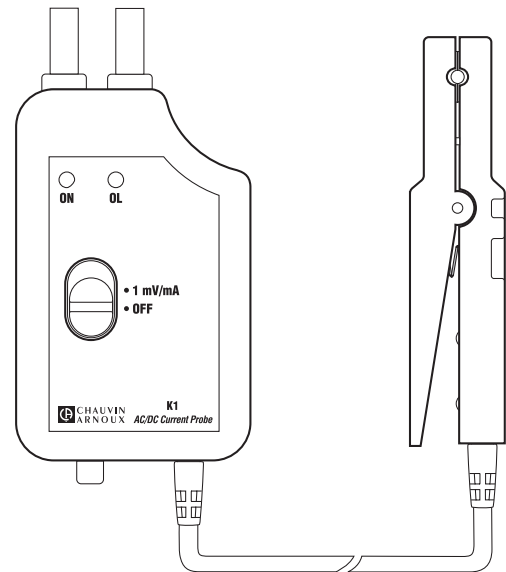

- Drop test:** 1.0 in accordance with IEC 68-2-32
- Shock resistance:** 100 g in accordance with IEC 68-2-27
- Vibration resistance:** in accordance with IEC 68-2-6
- Frequency range:**
 - 5 to 15 Hz, amplitude: 1.5 mm
 - 15 to 25 Hz: amplitude: 1 mm
 - 25 to 55 Hz: amplitude: 0.25 mm
- Dimensions:**
 - Electronic module: 124 x 64 x 28 mm
 - Probe: 111 x 15 x 25 mm
- Cable length:** 1.5 m
- Weight:** 250 g
- Colour:** Dark grey
- Output:** Two 4 mm safety terminals 19 mm apart. (standard)

SAFETY SPECIFICATIONS

- Operating voltage:** 300 V in accordance with IEC 1010-1 Cat. II
- Electromagnetic compatibility:**
 - Immunity (EN 50082-1): class A
 - DC: 15 mV for 0
 - AC (60 Hz): 2 dB from 10 mA .. 4.5 A
 - Emissivity (EN 50081-1): negligible

(1) Conditions of reference: 23 $^{\circ}$ C \pm 3 $^{\circ}$ C, 20% to 75% RH, batteries 9 V \pm 0.1 V, earth's magnetic field < 40 A/m, no AC field, DC or sinusoidal current from 45 Hz to 65 Hz

To order	Reference
AC/DC current clamp model K1 in carrying case with battery and user's manual	P01120067A

Model K2

Current	450 mA DC 300 mA AC
Output	10 mV/mA

DESCRIPTION

The K2 model measures currents as low as 100 μ A AC or DC. The probe has a proportional output for direct readings on multimeters.

ELECTRICAL SPECIFICATIONS

- Current calibres:**
 - 0.1 mA DC .. \pm 450 mA DC
 - 0.1 mA RMS .. 300 mA RMS (sinusoidal)
 - 0.1 mA peak .. 450 mA peak, signal square and steps
- Output (output voltage):**
10 mV/mA
- Resolution:**
DC: 50 μ A typical
AC: 100 μ A typical
- Accuracy ⁽¹⁾:**

- DC current

Primary current	0.1 mA .. 1 mA	1 mA .. 12 mA	12 mA .. 450 mA
% Accuracy of output signal	3% \pm 2 mV	2% \pm 2 mV	1%

- AC current from 45 Hz to 65 Hz

Primary current	0.1 mA .. 1 mA	1 mA .. 12 mA	12 mA .. 300 mA
% Accuracy of output signal	3% \pm 0.5 mV	2% \pm 0.5 mV	1%

- Frequency response:**
DC to 1.5 kHz (at -3 dB)
- Load impedance:**
 \geq 1 M Ω and \leq 100 pF
- Output noise:**
< 100 μ V DC to 1.5 kHz
- Output impedance:**
200 Ω
- Inductance of clamp:**
< 1 μ H
- Rise time:**
< 200 μ s, 10% at 90%
- Fall time:**
< 200 μ s, 90% at 10%
- Influence of adjacent conductors:**
(50 Hz at 23 mm from the clamp): < 100 μ A / A
- Influence of earth field:**
< 120 μ A, 0 .. max
- Battery:**
Alkaline 9 V, NEDA 1604, 6LR61 or IEC 6 LF22
- Low battery signal:**
Green LED when battery voltage > 6.5 V
- Battery charge life:**
Approximately 20 hours

- Overload indication:**
Red LED indicating momentary or continuous overload
- Max. current:**
100 A AC RMS or DC with current limitation according to with frequency, above 800 Hz

MECHANICAL SPECIFICATIONS

- Operating temperature:**
-10 $^{\circ}$ C to +55 $^{\circ}$ C
- Storage temperature:**
-40 $^{\circ}$ C to +80 $^{\circ}$ C
- Influence of temperature:**
< 500 ppm/ $^{\circ}$ K or 0.5% / 10 $^{\circ}$ C
- Humidity:**
< 95% at < 35 $^{\circ}$ C, 75% at 55 $^{\circ}$ C
Operating altitude: 0 to 2,000 m
- Adjustment of DC zero:**
Approximately \pm 15 mA by turning the button on the bottom of the housing (10 turns)
- Max. jaw insertion capacity:**
3.9 mm
- Protection rating:**
IP40 par IEC 529

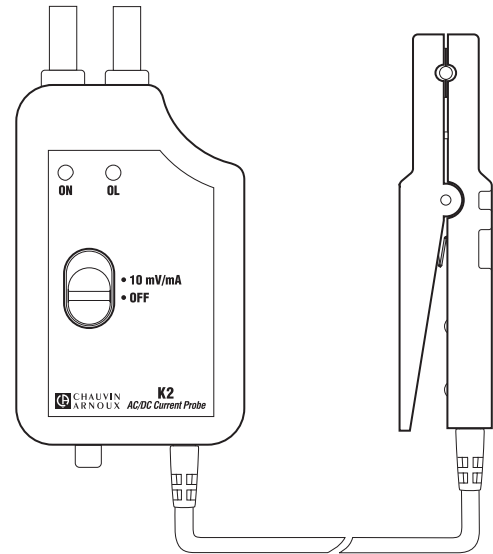

- Drop test:**
1.0 in accordance with IEC 68-2-32
- Shock resistance:**
100 g par IEC 68-2-27
- Vibration resistance:**
in accordance with IEC 68-2-6
- Frequency range:**
5 Hz .. 15 Hz, amplitude: 1.5 mm
15 Hz .. 25 Hz, amplitude: 1 mm
25 Hz .. 55 Hz, amplitude: 0.25 mm
- Dimensions (electronic module):**
124 x 64 x 28 mm
- Dimension (probe):**
111 x 15 x 25 mm
- Cable length:**
1.5 m
- Weight:**
250 g
- Colour:**
Dark grey
- Output:**
Two 4 mm safety terminals 19 mm apart (standard)

SAFETY SPECIFICATIONS

- Operating voltage:**
300 V in accordance with IEC 1010-1 Cat. II
- Electromagnetic compatibility:**
Immunity (EN 50082-1): class A
DC: 15 mV for 0
AC (60 Hz): 2 dB from 10 mA .. 4.5 A
Emissivity (EN 50081-1): negligible

(1) Conditions of reference: 23 $^{\circ}$ C \pm 3 $^{\circ}$ C, 20 $^{\circ}$ C to 75% RH, batteries 9 V \pm 0.1 V, earth's magnetic field < 40 A/m, no AC field, DC or sinusoidal current from 45 Hz to 65 Hz

To order	Reference
AC/DC current clamp model K2 in carrying case with battery and user's manual	P01120074A



SERIE E_N

The E_N series clamps use Hall-effect technology for the measurement of AC and DC currents from several milliamps to over 100 A.

These clamps' narrow, elongated design makes them ideal for measurements in cable bundles or in other confined areas like circuit boards, motor controls or motor vehicle electrical circuits.

Their low phase shifting also ensures excellent performance for power measurements.

These clamps have a voltage output (mv) and their ability to measure AC and DC signals is useful for true RMS measurements.

Model E6N is the most sensitive for low current measurements.

The E series clamps all make excellent work mates for multimeters, recorders and logging equipment, etc. Model E3N can even be connected directly to an oscilloscope.

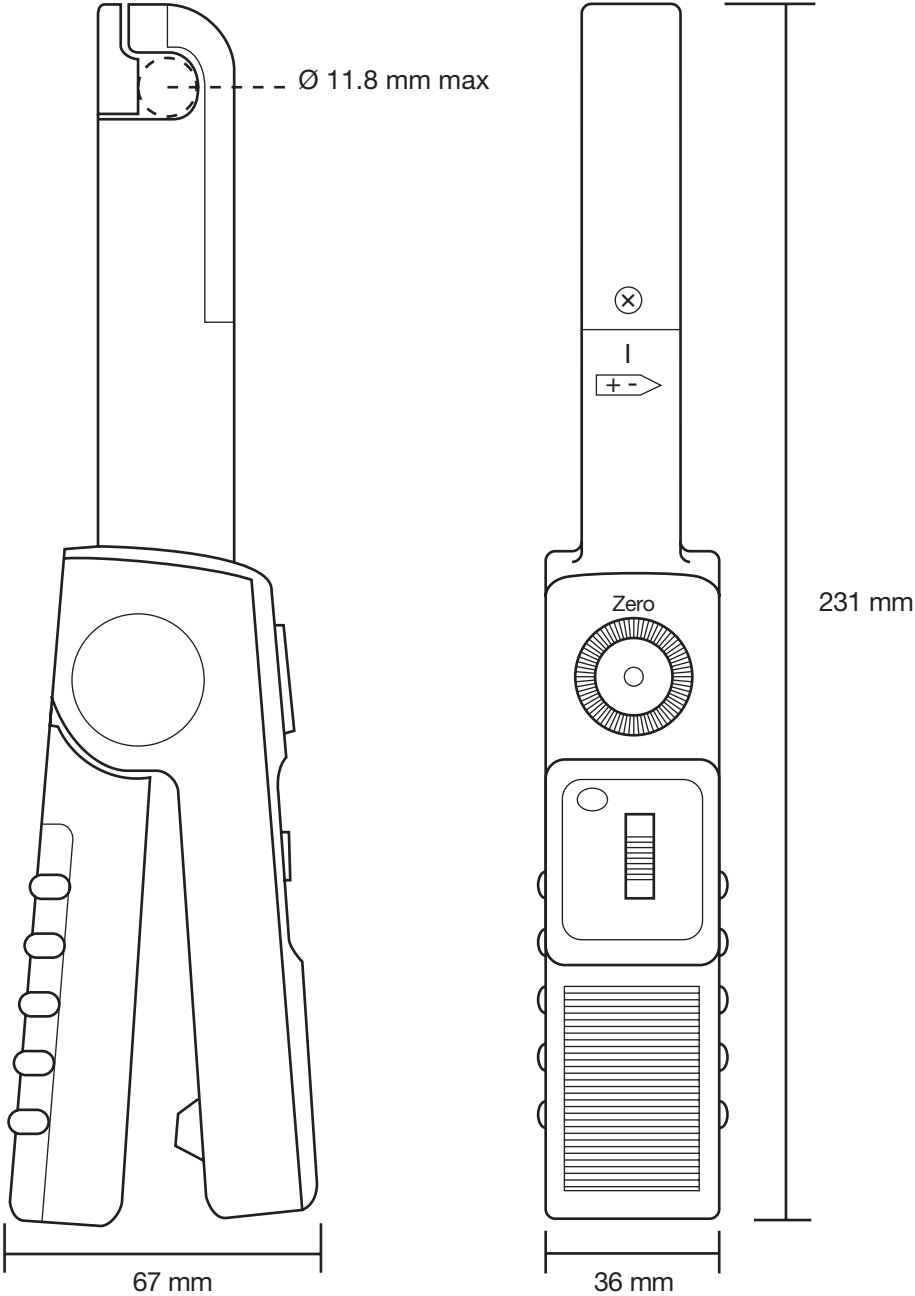

Model E1N

Current	2 A AC/DC	150 A AC/DC
Output	1 mV/mA	1 mV/A

ELECTRICAL SPECIFICATIONS

- **Current range:**
50 mA .. 150 A AC/DC over two calibres
- **Output signal:**
1 mV/mA and 1 mV/A AC or DC
- **Accuracy and phase shift (1):**

Calibre	1 mV/mA (1 V/A)	1 mV/A
Current range	50 mA .. 2 A DC 50 mA .. 1.5 A AC	500 mA .. 150 A
Accuracy in % of output signal	2% ± 20 mV	500 mA .. 100 A AC/DC: 1.5% ± 30 µV 100 A .. 150 A DC: 3% 100 A .. 120 A AC: 3%
Frequency range	DC .. 65 Hz: 3°	DC .. 65 Hz: 1°
Phase shift	not specified	not specified
Load impedance minutes	≥ 10 kΩ	≥ 2 kΩ
Noise	DC .. 1 Hz: 3 mV 1 Hz .. 10 kHz: 10 mV 10 kHz .. 100 kHz: 18 mV	DC .. 1 Hz: 3 µV 1 Hz .. 10 kHz: 10 µV 10 kHz .. 100 kHz: 18 µV

- **Operating voltage:**
600 V RMS max
- **Common mode voltage:**
600 V RMS max
- **Battery:**
9 V alkaline (NEDA 1604A, IEC 6LR61)
- **Battery life:**
70 hours typical
- **Typical consumption:**
6 mA
- **Battery level indicator:**
Green LED when > 6.5 V

MECHANICAL SPECIFICATIONS

- **Operating temperature:**
0° to +50 °C
- **Storage temperature:**
-30 °C to +80 °C
- **Influence of temperature:**
< 0.2% per °C

- **Relative humidity for operation:**
+10 °C to +30 °C:
85 ± 5% RH (without condensation)
+40 °C to +50 °C:
45 ± 5% RH (without condensation)
- **Operating altitude:**
0 to 2,000 m
- **Max. jaw insertion capacity:**
11.8 mm
- **Zero adjustment:**
20 turns of potentiometer (± 1.5 A minutes)
- **Drop test:**
1 m on a 38 mm container of oak on concrete, test in accordance with IEC 1010
- **Shock resistance:**
100 g, in accordance with IEC 68-2-27
- **Vibration resistance:**
10/55/10 Hz, 0.15 mm
test in accordance with IEC 68-2-6
- **Casing protection rating:**
IP20 in accordance with IEC 529
- **Self-extinguishing capability:**
Casing: UL94 V2

- **Dimensions:**
231 x 36 x 67 mm
- **Weight:**
330 g with batteries
- **Colour:**
Dark grey
- **Output:**
1.5 m two-wire lead with double or reinforced insulation terminated by 2 elbowed male safety plugs (4 mm)

SAFETY SPECIFICATIONS

- **Electrical safety:**
600 V category III, pollution 2
300 V category IV, pollution 2
- **Electromagnetic compatibility (EMC):**
EN 50081-1: class B
EN 50082-2:
- Electrical discharge IEC 1000-4-2
- Radiated field IEC 1000-4-3
- Fast transients IEC 1000-4-4
- Magnetic field at 50/60 Hz: IEC 1000-4-8

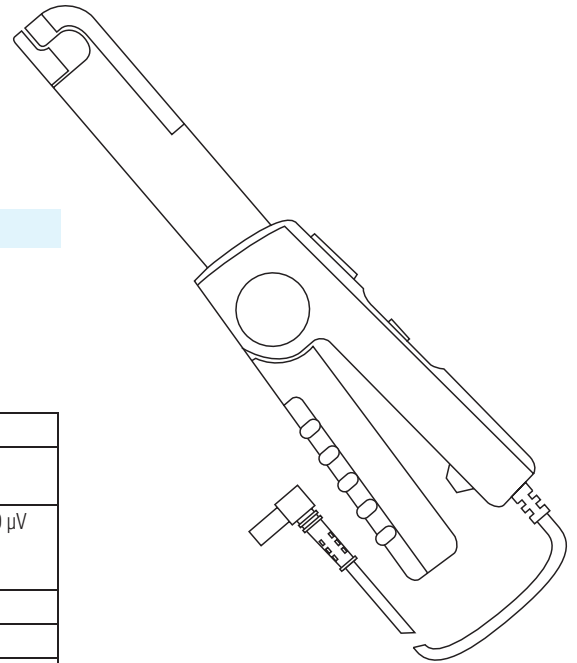

(1) Conditions of reference: 23 °C ± 5 °K, 20 to 75% RH, 48 to 65 Hz, external magnetic field < 40 A/m, no current-carrying conductor nearby, centred test sample, load impedance 1 MΩ.

To order	Reference
AC current clamp/DC model E1N with battery and user's manual	P01120030A

Model E3N (insulated AC current probe/DC)

Current	10 A peak	100 A peak
Output	100 mV/A	10 mV/A

DESCRIPTION

The E3N clamp is designed to measure AC and DC currents by using Hall-effect technology. Its narrow, elongated shape makes it ideal for measurements in cable bundles or in confined spaces such as the wiring on switchboards, motor control units and electrical circuits on motor vehicles. It is particularly appreciated for its True RMS measurements on AC+DC signals. It offers 2 different sensitivities.

ELECTRICAL SPECIFICATIONS

- **Current range:**
0.1 A .. 10 A peak
0.5 A .. 100 A peak
- **Output signal:**
100 mV AC+DC / A AC+DC (1 V for 10 A)
10 mV AC+DC / A AC+DC (1 V for 100 A)
- **Accuracy and phase shift ⁽¹⁾:**

Calibre	10 A		100 A	
	Current range	% Accuracy of output signal	Phase shift	
Current range	100 mA .. 10 A peak	500 mA .. 40 A peak	40 A .. 100 A peak	
% Accuracy of output signal	≤ 3% + 5 mV	≤ 4% + 500 μV	≤ 15%	
Phase shift	≤ 1.5°	≤ 1°	≤ 1°	

- **Bandwidth:**
DC .. 100 kHz (-3 dB) (depending on current value)
- **Rise/fall time from 10% to 90%:**
10 A calibre: 3 μs
100 A calibre: 4 μs
- **10% delay time:**
10 A calibre: 2,7 μs
100 A calibre: 1,8 μs
- **Insertion impedance (at 10 kHz / 50 kHz):**
< 1.3 mΩ / < 10 mΩ
- **DC zero adjustment:**
20 turns of potentiometer
- **Typical output noise level (peak-peak) from DC to 100 kHz:**
10 A calibre: 6 mV
100 A calibre: 600 μV
- **Battery:**
9 V alkaline (NEDA 1604A, IEC 6LR61)
- **Battery life:**
55 hours typical
- **Typical consumption:**
8.6 mA typical / 12 mA max.
- **Battery level indicator:**
Green LED when > 6.5 V
- **Overload indication:**
Red LED indicates the measured current is too high for the selected range
- **Influence of temperature:**
≤ 2,000 ppm /°C
- **Influence of conductor position in jaws:**
≤ 0.5% of output signal at 1 kHz

- **Common mode voltage (600 V max) for AC measurements (typical/max):**
10 A calibre:
At 50 Hz: 3.48 mA/100 V / 5 mA/100 V
At 400 Hz: 25.91 mA/100 V / 50 mA/100 V
100 A calibre: no measurement

MECHANICAL SPECIFICATIONS

- **Clamping capacity:**
Cable: Ø max 11.8 mm
- **Output:**
Via 2 m coaxial cable terminated by BNC insulated plug
- **Dimensions:**
231 x 67 x 36 mm
- **Weight:**
330 g with battery
- **Operating temperature:**
0° à +50°C
- **Storage temperature:**
-30°C to +80°C
- **Relative humidity for operation:**
0 to 85% RH with a linear decrease above 35°C
- **Operating altitude:**
0 to 2,000 m
- **Casing protection rating:**
IP20 (IEC 529)
- **Drop test:**
1 m (IEC 68-2-32)

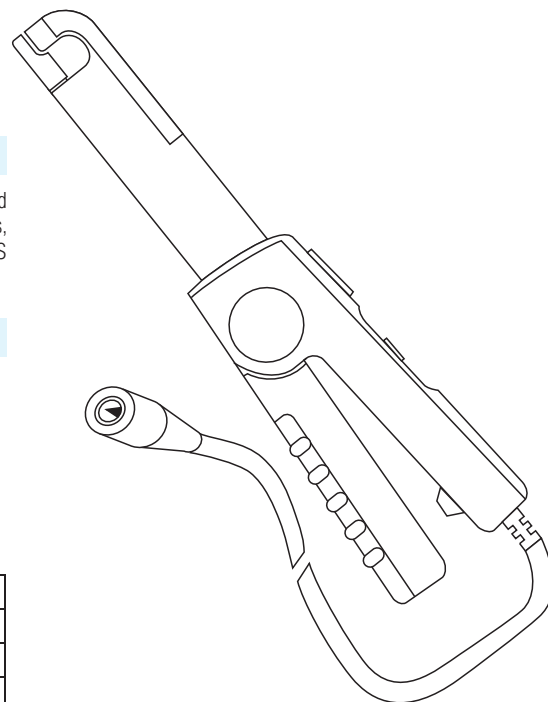

- **Shock resistance:**
100 g / 6 ms / half-period (IEC 68-2-27)
- **Vibration resistance:**
10/55/10 Hz, 0.15 mm (IEC 68-2-6)
- **Self-extinguishing capability:**
UL94 V2
- **Colour:**
Dark grey

SAFETY SPECIFICATIONS

- **Electrical safety:**
Instrument with double insulation or reinforced insulation between the primary the secondary and the grippable part located under the guard as per IEC 1010-1 & IEC 1010-2-032
- 600 V category III, pollution degree 2
- 300 V category IV, pollution degree 2
- **Electromagnetic compatibility (EMC):**
EN 50081-1: class B
EN 50082-2:
- Electrostatic discharge IEC 1000-4-2:
4 kV level 2 performance criterion B
8 kV in the air level 3 performance criterion B
- Radiated field IEC 1000-4-3:
10 V/m performance criterion A
- Fast transients IEC 1000-4-4:
1 kV level 2 performance criterion B
2 kV level 3 performance criterion B
- Magnetic field at the network frequency (IEC 1000-4-8):
field of 400 A/m at 50 Hz: < 1 A

CURVES

100 A calibre

Linearity with DC

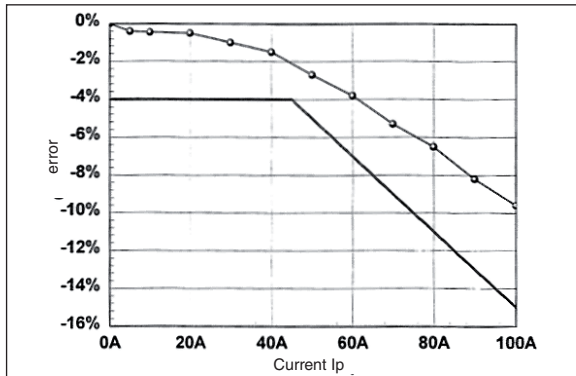

Frequency response

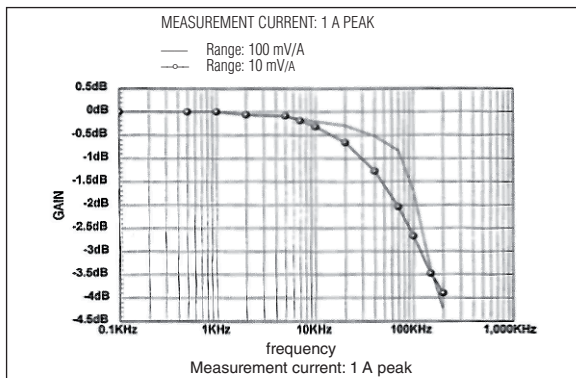

Phase shift

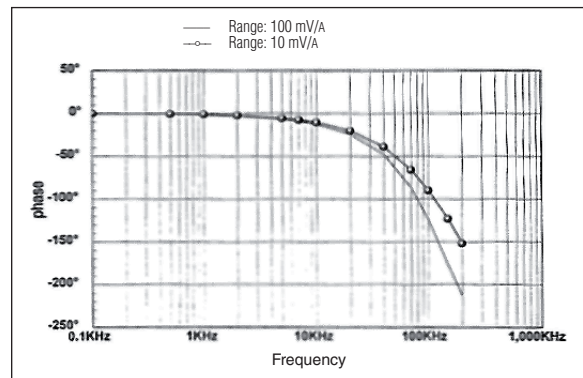

Immunity regarding an external conductor

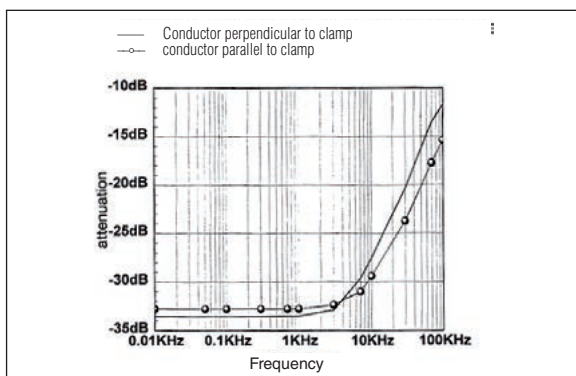

Limitation of measurable current according to the frequency

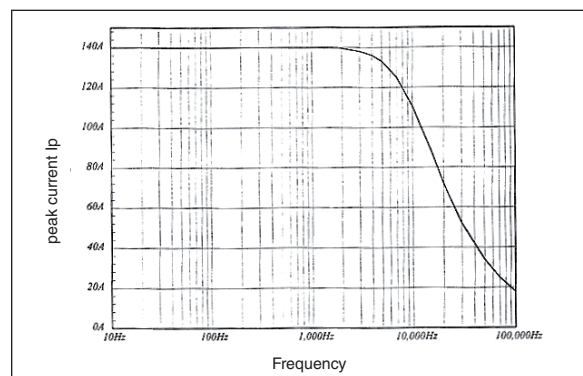

CURVES

100 A calibre

1 A peak

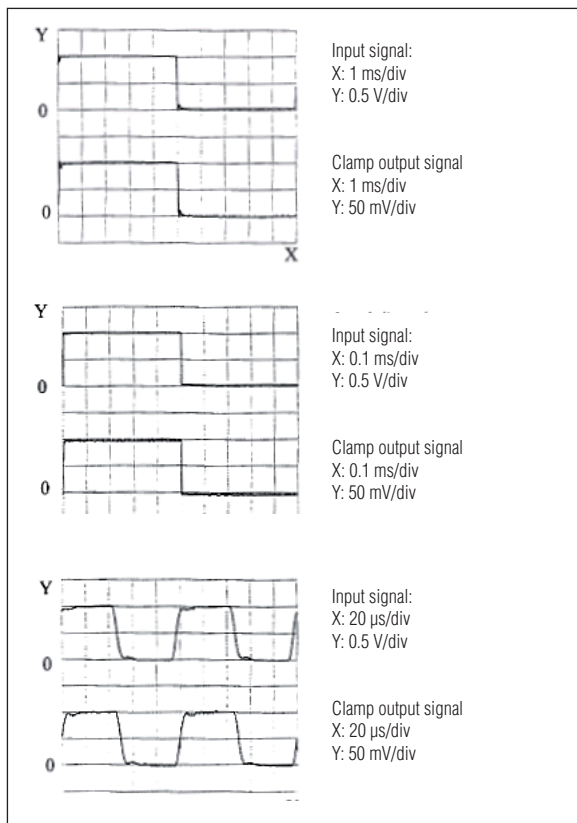

2 A peak

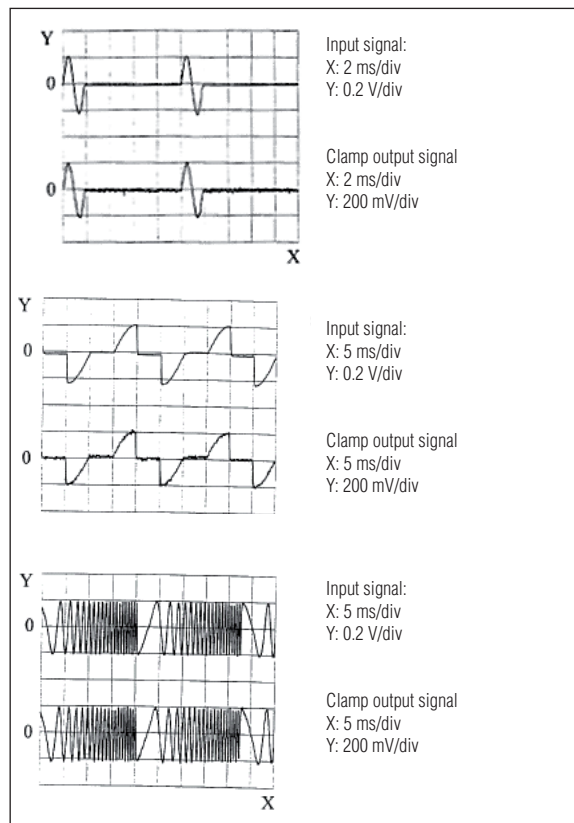

0.1 A peak

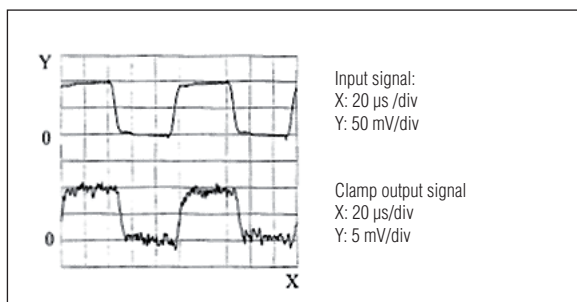

CURVES

10 A calibre

10 A peak

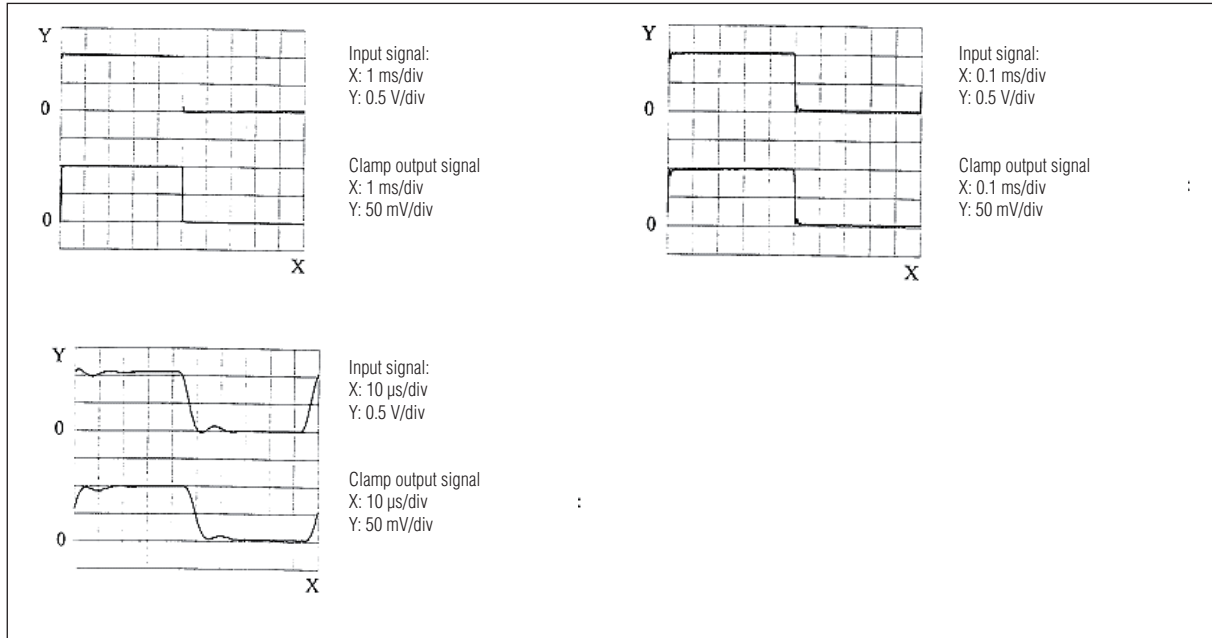

Insertion impedance

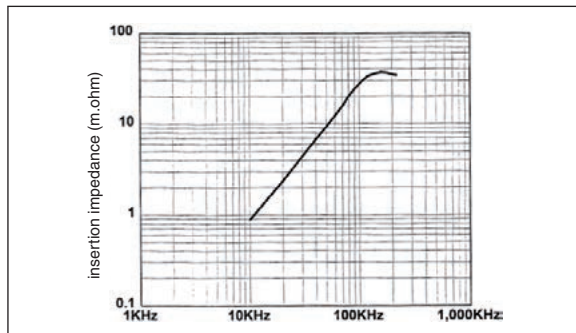

(1) Conditions of reference: 23 °C ± 5 °K, 20 % to 75 % RH, power supply voltage 8 V ± 0.1 V DC sinusoidal signal with frequency of DC to 1 kHz, external magnetic field < 40 A/m, no DC components, no external conductor with circulating current, conductor centred for measurement, load impedance > 1 MΩ / < 100 pF.

To order	Reference
AC/DC current clamp model E3N for oscilloscope, with battery and user's manual	P01120043A
AC/DC current clamp model E3N for oscilloscope, with mains power, battery and user's manual	P01120047

Model E6N

Calibre	2 A AC/DC	80 A AC/DC
Output	1 mV/mA	10 mV/A

ELECTRICAL SPECIFICATIONS

- **Current range:**
5 mA .. 80 A AC/DC over two calibres
- **Output signal:**
1 mV/mA and 10 mV/A AC or DC
- **Accuracy and phase shift ⁽¹⁾:**

Calibre	1 mV/mA (1 V/A)	10 mV/A
Current range	5 mA .. 2 A DC 5 mA .. 1.5 A AC	20 mA .. 80 A DC 20 mA .. 80 A AC
% Accuracy of output signal	2% ± 5 mV	20 mA .. 50 A DC: 4% ± 200 µV 50 A to 80 A DC: 12% 20 mA .. 40 A AC: 4% ± 200 µV 40 A to 60 A AC: 12%
Frequency range	DC .. 2 kHz	DC .. 8 kHz
Phase shift	DC .. 65 Hz: 1°	DC .. 65 Hz: 1°
Load impedance minutes	> 10 kΩ	> 2 kΩ
Noise	DC .. 1 Hz: 2 mV 1 Hz .. 10 kHz: 10 mV 10 .. 100 kHz: 10 mV	DC .. 1 Hz: 20 µV 1 Hz .. 10 kHz: 100 µV 10 .. 100 kHz: 100 µV

- **Overload:**
120 A continuous
- **Operating voltage:**
600 VRMS max
- **Common mode voltage:**
600 VRMS max
- **Battery:**
9 V alkaline (NEDA 1604A, IEC 6LR61)
- **Battery life:**
70 hours typical
- **Typical consumption:**
6 mA
- **Battery level indicator:**
Green LED when > 6.5 V
- **Relative humidity for operation:**
+10° to +30 °C:
85 ± 5 % RH (without condensation)
+40 °C to +50 °C:
45 ± 5 % RH (without condensation)
- **Operating altitude:**
0 to 2,000 m
- **Max. jaw insertion capacity:**
11.8 mm
- **Zero adjustment:**
20 turns of potentiometer (± 1.5 A minutes)
- **Drop test:**
1 m on a 38 mm container of oak on concrete, test in accordance with IEC 1010
- **Shock resistance:**
100 g, in accordance with IEC 68-2-27
- **Vibration resistance:**
10/55/10 Hz, 0.15 mm
test in accordance with IEC 68-2-6
- **Casing protection rating:**
IP20 in accordance with IEC 529
- **Self-extinguishing capability:**
Casing: UL94 V2

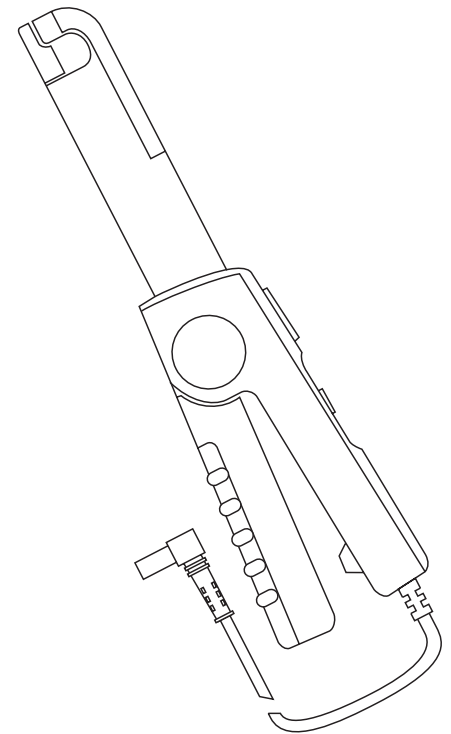

- **Dimensions:**
231 x 36 x 67 mm
- **Weight:**
330 g with batteries
- **Colour:**
Dark grey
- **Output:**
1.5 m two-wire lead with double or reinforced insulation terminated by 2 elbowed male safety plugs (4 mm)

SAFETY SPECIFICATIONS

- **Electrical safety:**
600 V category III, pollution: 2
300 V category IV, pollution: 2
- **Electromagnetic compatibility (EMC):**
EN 50081-1: class B
EN 50082-2:
- Electrical discharge IEC 1000-4-2
- Radiated field IEC 1000-4-3
- Fast transients IEC 1000-4-4
- Magnetic field at 50/60 Hz IEC 1000-4-8

MECHANICAL SPECIFICATIONS

- **Operating temperature:**
0 °C to +50 °C
- **Storage temperature:**
-30 °C to +80 °C
- **Influence of temperature:**
< 0.2 % per °C

(1) Conditions of reference: 23 °C ±5K, 20 to 75 % RH, 48 to 65 Hz, external magnetic field < 40 A/m, no current-carrying conductor nearby, centred test sample, load impedance 1 MΩ

To order	Reference
AC current clamp/DC model E6N with battery and user's manual	P01120040A



MH SERIES

The MH60 clamp is designed to measure DC and AC currents up to 1 MHz using dual Hall effect/Transformer technology.

It includes an internal NiMh rechargeable battery and can be recharged or powered using a 5 VDC power supply via the female type-B μUSB connector with which it is equipped.

It has an automatic standby system (which can be deactivated), an automatic "DCzero" system for compensation of magnetic and electronic drift, a switchable selective filter (3 kHz, 30 kHz) and a system for compensating the effects of the earth field and other constant DC fields.

Its ability to measure AC+DC signals is useful for True RMS measurements.

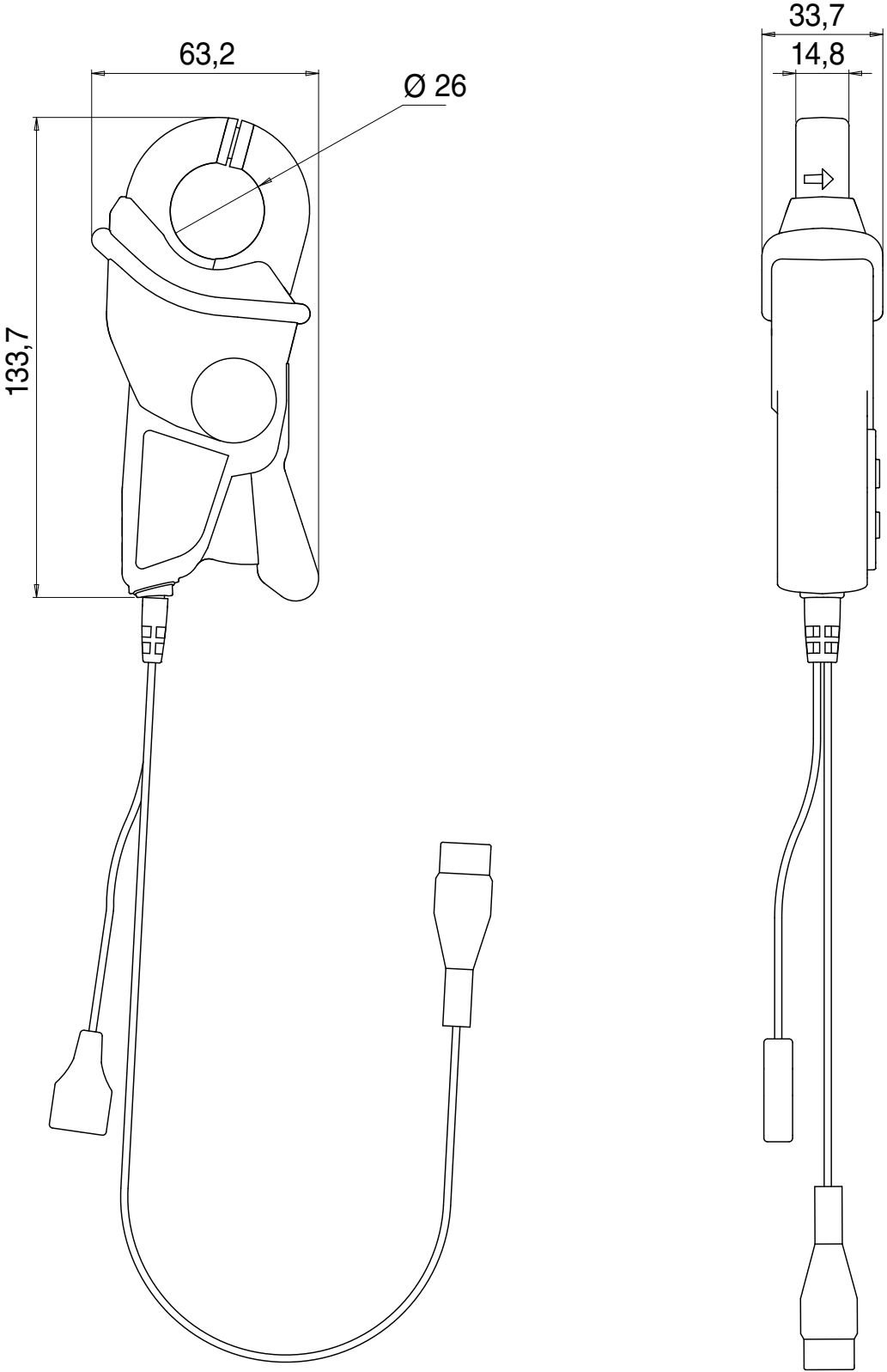

Model MH60 (insulated AC/DC current probe)

Current	140 A peak
Output	10 mV/A

DESCRIPTION

The MH60 clamp is designed to measure DC and AC currents up to 1 MHz using dual Hall effect/Transformer technology.

ELECTRICAL SPECIFICATIONS

- Current range:**
0.5 .. 100 A DC (140 A peak)
- Output signal:**
10 mV AC+DC / A AC+DC (1 V at 100 A)
- Accuracy and phase shift (1):**

Calibre	100 A			
Primary current	15 mA .. 0.7 A peak (10 mA .. 0.5 ARMS or DC)	0.7 A .. 90 A peak (0.5 A .. 64 ARMS or DC)	90 A .. 125 A peak (64 A .. 90 ARMS or DC)	125 A .. 140 A peak (90 A .. 100 ARMS or DC)
% Accuracy of output signal	NS	≤ 1.5 % + 100 μV	≤ 4 %	≤ 5 %
Phase shift @ 50 Hz (2)	NS	≤ 1°	≤ 1°	≤ 1°

- Bandwidth:**
DC .. 1 MHz (-3 dB) (depending on current value)
- Rise time and fall time:**
From 10 % to 90 %
Without filter: 350 ns
With filter 30 kHz: 11.7 μs
With filter 3 kHz: 117 μs
- di/dt @ 2 A peak-peak:**
5 A / μs
- Delay time @ 2 A peak-peak:**
0.35 μs typical
- Insertion impedance:**
~ 0.25 mΩ @ 400 Hz
~ 0.628 mΩ @ 1 MHz
- DC zero adjustment:**
±3 A by pushbutton
- Noise RMS:**
Without filter: 15 mA typical (< 88 mA peak-peak)
30 kHz filter: 5 mA typical (< 36.6 mA peak-peak)
3 kHz filter: 4 mA typical (< 35.8 mA peak-peak)
- Battery:**
Internal NiMh rechargeable battery + 5 VDC
external via female μUSB type B connection
- Battery life:**
8 hours typical with fully-charged battery
- Typical consumption:**
< 150 mA (battery charging)
- Low battery signal:**
Flashing green LED x 2 hours
- Overload indication:**
RED "OL" LED to indicate excessive measurement current

- Influence of temperature:**
-10 °C .. +45 °C: ≤ 1,200 /°C
+45 °C .. +50 °C: ≤ 2,200 ppm /°C
- Influence of conductor position in jaws:**
≤ 1.5 % of output signal
- Common mode voltage (600 V max) for AC measurements (typical/max):**
at 50 Hz: 3.5 mA/5 mA @ 100 V
at 400 Hz: 25.9 mA/50 mA @ 100 V

MECHANICAL SPECIFICATIONS

- Clamping capacity:**
Cable: Ø max 26 mm
- Max. jaw insertion capacity:**
≤ 90 °C
- Output:**
Built-in cable 2 m long with moulded isolated male BNC plug
- Dimensions:**
138 x 49 x 28 mm
- Weight:**
200 g approx.
- Operating temperature:**
-10 °C to +50 °C
- Storage temperature:**
-20 °C to +50 °C
- Relative humidity for operation:**
0 to 85 % RH with a linear decrease above 35 °C
- Operating altitude:**
0 to 2,000 m
- Casing protection rating:**
IP 40 (EN 60529)

- Drop test:**
1 m (EN 60068-2-32)
- Shock resistance:**
100 g / 6 ms / half-periode (IEC 68-2-27)
- Vibration resistance:**
10/55/10 Hz, 0.15 mm (IEC 68-2-6)
- Self-extinguishing capability:**
UL94 V2
- Colours:**
Casing: dark grey
Jaws: red

SAFETY SPECIFICATIONS

- Electrical safety:**
Instrument with double insulation or reinforced insulation between the primary the secondary and the grippable part located under the guard as per IEC 1010-1 & IEC 1010-2-032
- 600 V category II, pollution degree 2
- 300 V category III, pollution degree 2
- Electromagnetic compatibility (EMC):**
EN 50081-1: class B
EN 50082-2:
- Electrostatic discharge (IEC 1000-4-2):
4 kV level 2 performance criterion B
8 kV in the air level 3 performance criterion B
- Radiated field (IEC 1000-4-3):
10 V/m performance criterion A
- Fast transients (IEC 1000-4-4):
1 kV level 2 performance criterion B
2 kV level 3 performance criterion B
- Magnetic field at the network frequency (IEC 1000-4-8):
field of 400 A/m at 50 Hz: < 1 A

(1) Conditions of reference: 23 °C ± 5 °K, 20 at 75 % RH, power supply voltage 5 V ± 5 % V DC sinusoidal signal with frequency of DC at 400 Hz, external magnetic field < 40 A/m, no DC components, no external conductor with circulating current, conductor centred for measurement, load impedance > 1 MΩ / < 100 pF.

(2) without filter.

To order	Reference
AC/DC clamp model MH60 with a 100 V-240 V 50/60 Hz mains adapter, 1.5 A USB-A, type-A male USB ↔ type-B male μUSB cable 1.80 m long, verification certificate and 5-language user manual	P01120612



CURVES

Linearity in DC 100 A calibre

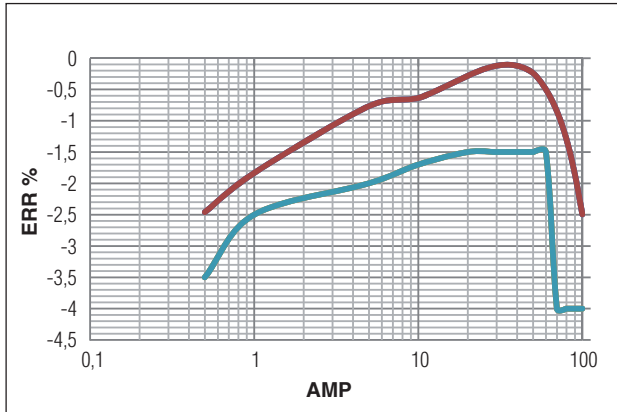

Frequency response to 0.5 A

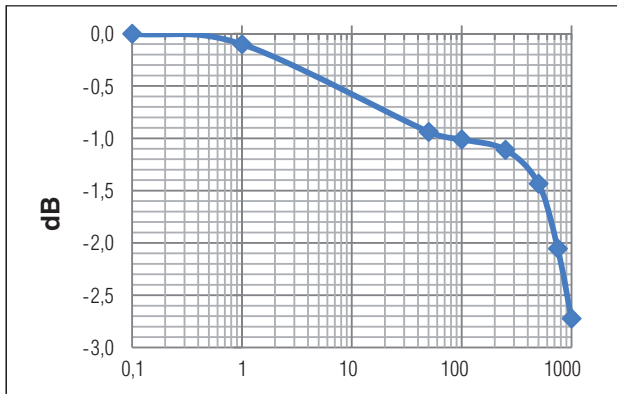

Insertion impedance

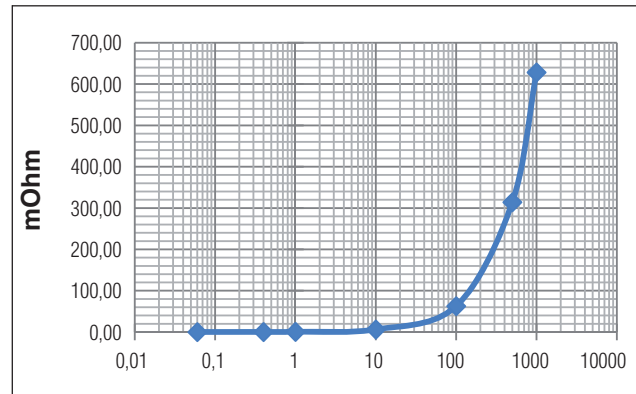

Phase shift at 3 A

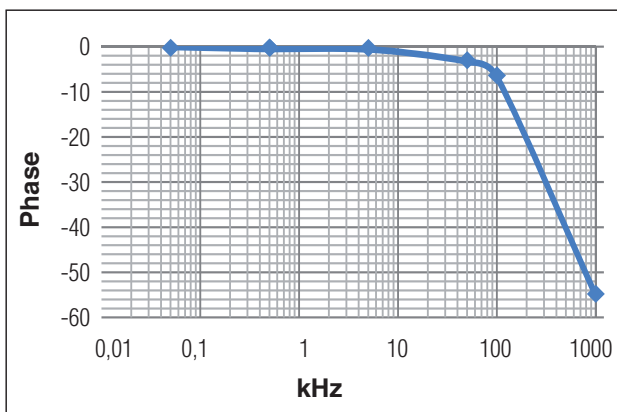

Limitation of measurable current according to the frequency

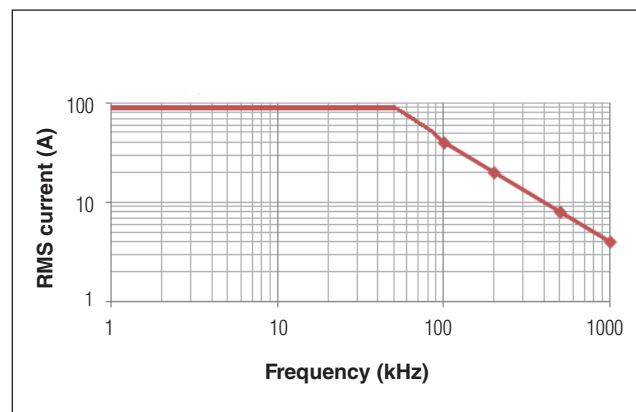

CURVES

1 A peak

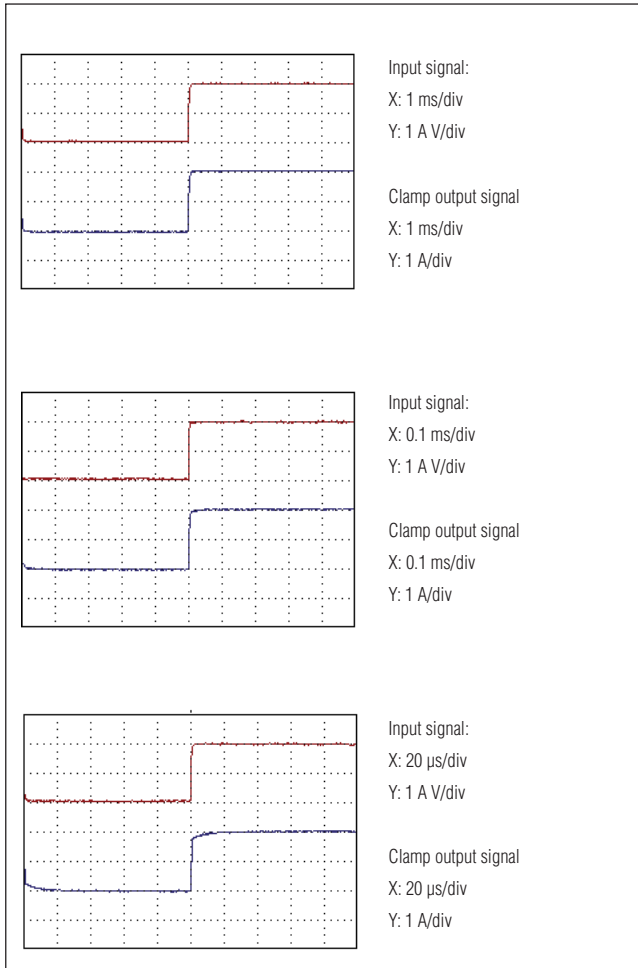

2 A peak

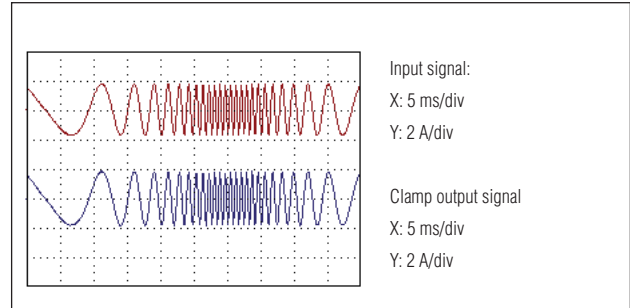

1 A peak

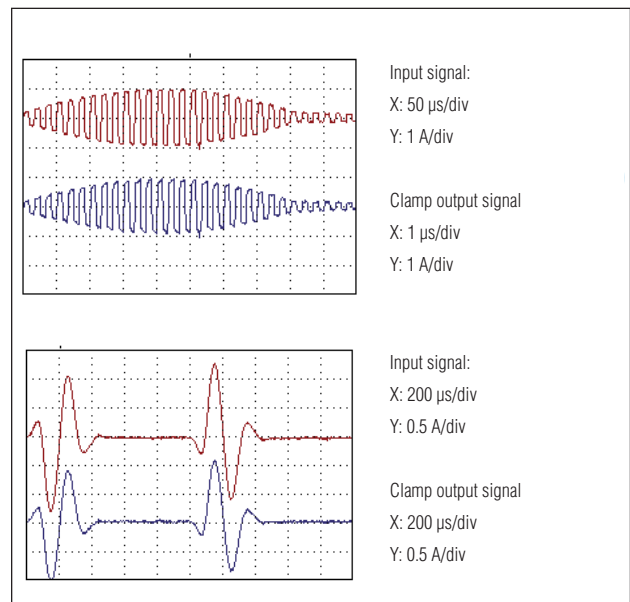

0.1 A peak

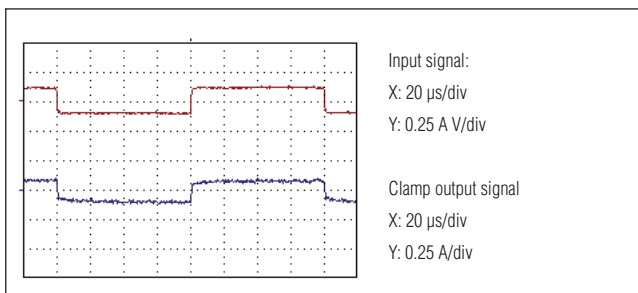



PAC SERIES

The PAC series is a range of professional AC/DC current clamps.

There are two different jaw designs available for clamping cables and small busbars.

The PAC series clamps operate on the Hall effect principle, allow current measurement up to 1,500 A DC and 1,000 A AC. The electronics and the batteries are all located in the clamp handles. There are two sensitivity levels available: 1 mV/A and 10 mV/A.

A push button operates the automatic DC zeroing on models PAC 11, 12, 21 and 22.

Models PAC 10 and PAC 20 have potentiometer-operated zero adjustment.

TRMS measurement with the DC component is possible using a multimeter or power meter with suitable capabilities.

Models PAC 12 and PAC 22 are designed for use with oscilloscopes and other BNC-input instruments.

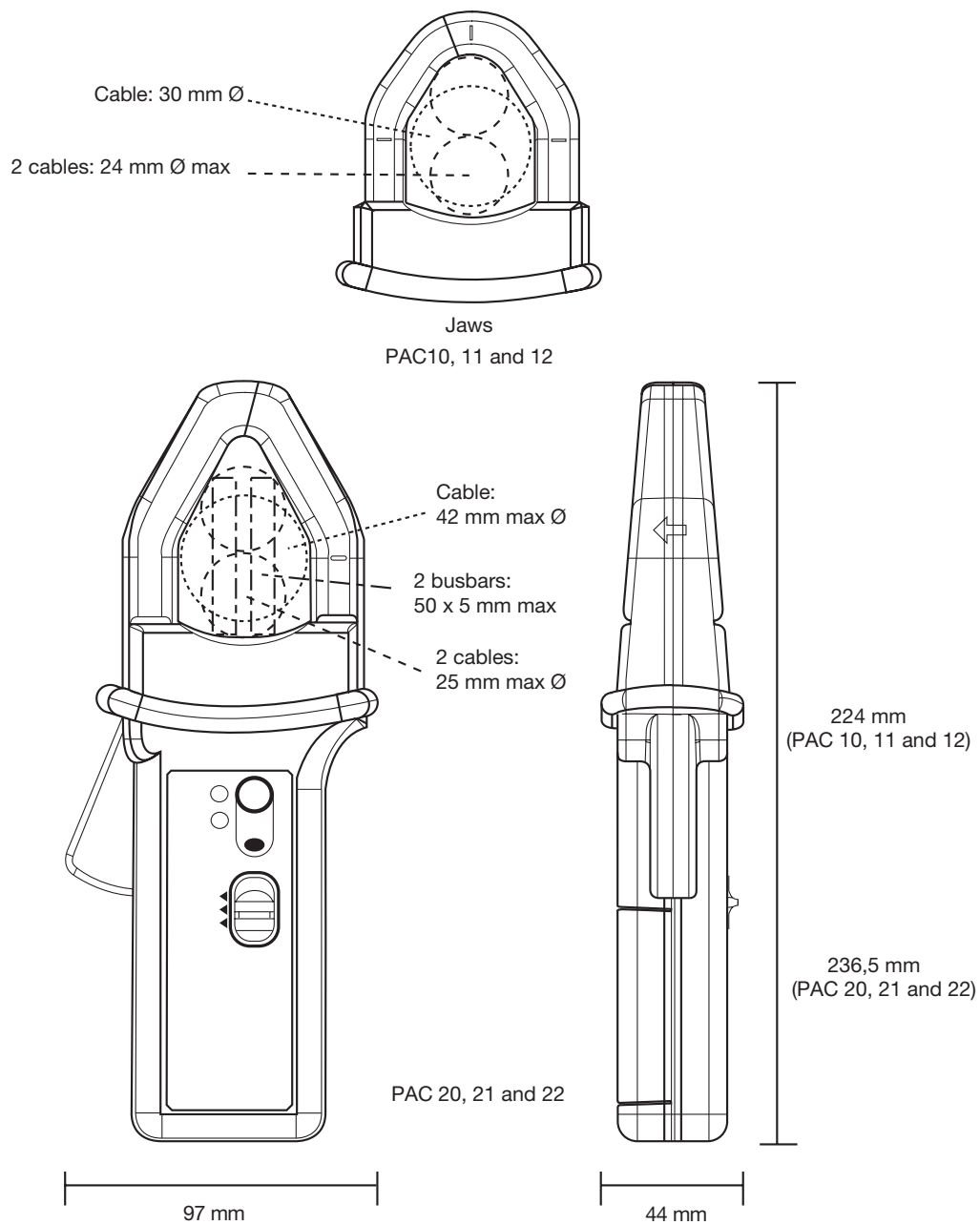

Current clamp for AC/DC current

Model PAC10

PAC series

Current	400 A AC 600 A DC
Output	1 mV/A

DESCRIPTION

Model PAC10 operates using the Hall effect, for precise measurement of AC or DC currents. It has a mV output so that a direct reading may be made on a multimeter or logging equipment, etc.

ELECTRICAL SPECIFICATIONS

- **Current calibres:**
0.5 A AC .. 400 A AC (600 A peak)
0.5 A AC .. 600 A DC
- **Output signal:**
1 mV/A
- **Accuracy ⁽¹⁾:**

Current range	1 A .. 100 A	100 A .. 400 A
Accuracy in % of output signal	1.5% ± 1 mV	2% 400 A .. 600 A DC: 2.5%

- **Phase shift ⁽¹⁾:**

Current range	10 A .. 200 A	200 A .. 400 A
Phase shift from 45 Hz .. 65 Hz	< 2.5°	< 2°

- **Overload:**
2,000 A DC and 1,000 A AC up to 1 kHz
- **Bandwidth:**
DC .. 5 kHz
- **Noise:**
DC at 1 kHz: < 1 mV
DC at 5 kHz: < 1.5 mV
0.1 Hz at 5 kHz: < 500 µV
- **Load impedance:**
1 MΩ and ≤ 100 pF
- **Insertion impedance:**
0.39 mΩ at 50 Hz, 58 mΩ at 1,000 Hz
- **Rise time and fall time:**
< 100 µs from 10 % to 90 % of the voltage value
- **Operating voltage:**
600 V_{RMS}
- **Common mode voltage:**
600 V_{RMS}
- **Influence of adjacent conductor:**
< 10 mA/A at 50 Hz
- **Influence of conductor position in jaws:**
0.5 % of the reading
- **Battery:**
9 V alkaline (NEDA 1604 A, IEC 6LR61)
- **Low battery signal:**
Green LED when the battery voltage > 6.5 V
- **Battery life:**
120 hours with Alkaline battery

MECHANICAL SPECIFICATIONS

- **Operating temperature:**
-10 °C to +55 °C
- **Storage temperature:**
-40 °C to +80 °C
- **Relative humidity for operation:**
+10 °C to +35 °C: 90 ± 5 % RH (without condensation)
+40 °C to +55 °C: 70 ± 5 % RH (without condensation)
- **Influence of temperature:**
< 300 ppm/°K or 0.3%/10 °K
< 0.3 A/°K
- **Influence of humidity:**
10 % to 90 % RH at reference temperature: < 0.1 %
- **Operating altitude:**
0 to 2,000 m
- **DC zero adjustment:**
±12 A (10-turn potentiometer)
- **Max. jaw insertion capacity:**
1 cable Ø 30 mm or 2 cables from Ø 24 mm
- **Casing protection rating:**
IP30 in accordance with IEC 529
- **Drop test:**
1 m on a 38 mm container of oak on concrete, test in accordance with IEC 1010

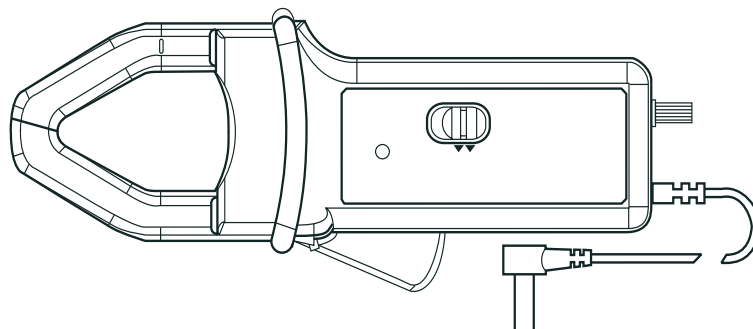

- **Shock resistance:**
100 g, in accordance with IEC 68-2-27
- **Vibration resistance:**
Test in accordance with IEC 68-2-6
- **Frequency range:**
5 Hz to 15 Hz: amplitude: 1.5 mm
15 Hz to 25 Hz: amplitude: 1 mm
25 Hz to 55 Hz: amplitude: 0.25 mm
- **Self-extinguishing capability:**
Casing and jaws: UL94 V0
- **Dimensions:**
224 x 97 x 44 mm
- **Weight:**
440 g
- **Colours:**
Dark grey and red jaws
- **Output:**
Via 1.5 m double insulated cable with 4 mm male safety plug

SAFETY SPECIFICATIONS

- **Electrical safety:**
Double or reinforced insulation between the primary, the secondary and outer casing in accordance with IEC 1010-1-2 (indoor use).
600 V category III, pollution 2
300 V category IV, pollution 2
- **Electromagnetic compatibility (EMC):**
EN 50081-1: class B
EN 50082-2:
- Electrical discharge IEC 1000-4-2
- Radiated field IEC 1000-4-3
- Fast transients IEC 1000-4-4
- Magnetic field at 50/60 Hz IEC 1000-4-8

(1) Conditions of reference: 18 °C at 28 °C, 20 % to 75 % RH, 48 to 65 Hz, external magnetic field < 40 A/m, no DC component, no current-carrying conductor nearby, centred test sample, charge ≥ 1 MΩ and ≤ 100 pF, reset to zero before measurement (only DC) DC to 65 Hz, batteries 9 V ± 0.1 V

To order	Reference
AC/DC current clamp model PAC10 with battery and user's manual	P01120070

Current clamp for AC/DC current

Model PAC11

PAC series

Current	40 A AC 60 A DC	400 A AC 600 A DC
Output	10 mV/A	1 mV/A

DESCRIPTION

The PAC11 model accurately measures AC or DC currents using the Hall-effect principle. This clamp with mV output on BNC (direct reading on multimeters, etc.) is equipped with an automatic DC zero system.

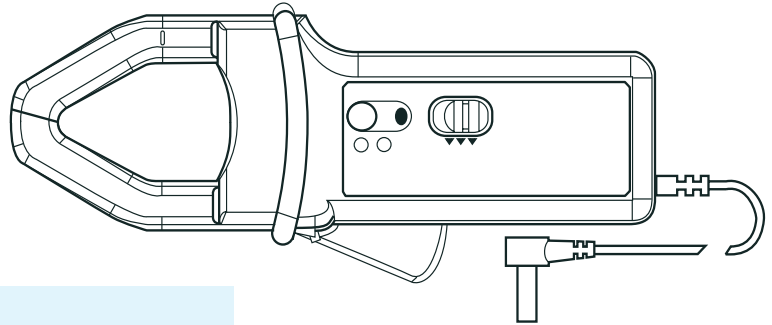

ELECTRICAL SPECIFICATIONS

Calibre	60 A	600 A
Current range	0.2 A .. 40 A (60 A peak) 0.4 A .. 60 A DC	0.5 A .. 400 A (600 A peak) 0.5 A .. 600 A DC
Output signal	10 mV/A	1 mV/A
% Accuracy of output signal ⁽¹⁾	0.5 A .. 40 A: 1.5 % ±5 mV 40 A .. 60 A DC: 1.5 %	0.5 A .. 100 A: 1.5 % ±1 mV 100 A .. 400 A DC: 2 % 400 A .. 600 A DC: 2.5 %
Phase shift (45 .. 65 Hz) ⁽¹⁾	10 A .. 20 A: < 3° 20 A .. 40 A: < 2°	10 A .. 100 A: < 2° 100 A .. 400 A: < 1.5°
Noise	DC .. 1 kHz: < 8 mV DC .. 5 kHz: < 12 mV 0.1 Hz .. 5 kHz: < 2 mV	DC .. 1 kHz: < 1 mV DC .. 5 kHz: < 1.5 mV 0.1 Hz .. 5 kHz: < 500 µV
Rise/fall time	≤ 100 µs from 10 % to 90 % of the voltage value	≤ 70 µs from 10 % to 90 % of the voltage value

- **Overload:**
2,000 A DC and 1,000 A AC up to 1 kHz
- **Bandwidth:**
DC .. 10 kHz at -3 dB
- **Load impedance:**
≥ 1 MΩ and ≤ 100 pF
- **Insertion impedance:**
0.39 mΩ at 50 Hz, 58 mΩ at 1,000 Hz
- **Operating voltage:**
600 V_{RMS}
- **Common mode voltage:**
600 V_{RMS}
- **Influence of adjacent conductor:**
< 10 mA/A at 50 Hz
- **Influence of conductor position in jaws:**
0.5 % of the reading
- **Battery:**
9 V alkaline (NEDA 1604 A, IEC 6LR61)
- **Low battery signal:**
Green LED when the battery voltage > 6.5 V
- **Battery life:**
50 hours with Alkaline battery.
- **Overload indication:**
Red LED
Auto switch-off: 0 minute

MECHANICAL SPECIFICATIONS

- **Operating temperature:**
-10 °C to +55 °C
- **Storage temperature:**
-40 °C to +80 °C
- **Relative humidity for operation:**
+10 °C to +35 °C:
90 ± 5 % RH (without condensation)
+40 °C to +55 °C:
70 ± 5 % RH (without condensation)
- **Influence of temperature:**
< 300 ppm/°K or 0.3 %/10 °K
< 0.3 A/°K
- **Influence of humidity:**
10 % at 90 % RH at reference temperature: < 0.1 %
- **Operating altitude:**
0 to 2,000 m
- **DC zero adjustment:**
Automatically operated by button (± 10 A)
- **Max. jaw insertion capacity:**
1 cable Ø 30 mm or 2 cables from Ø 24 mm or
2 busbars from 31.5 x 10 mm
- **Casing protection rating:**
IP30 in accordance with IEC 529

- **Drop test:**
1 m on a 38 mm container of oak on concrete,
test in accordance with IEC 1010
- **Shock resistance:**
100 g, in accordance with IEC 68-2-27
- **Vibration resistance:**
Test in accordance with IEC 68-2-6
- **Frequency range:**
5 Hz to 15 Hz: amplitude: 1.5 mm
15 Hz to 25 Hz: amplitude: 1 mm
25 Hz to 55 Hz: amplitude: 0.25 mm
- **Self-extinguishing capability:**
Casing and jaws: UL94 V0
- **Dimensions:**
224 x 97 x 44 mm
- **Weight:**
440 g
- **Colours:**
Dark grey and red jaws
- **Output:**
Via 1.5 m double insulated cable with 4 mm male safety plug

SAFETY SPECIFICATIONS

- **Electrical safety:**
Double or reinforced insulation between the primary and secondary circuits and the outer casing in accordance with IEC 1010-1-2 (indoor use).
600 V category III, pollution 2
300 V category IV, pollution 2
- **Electromagnetic compatibility (EMC):**
EN 50081-1: class B
EN 50082-2:
- Electrical discharge IEC 1000-4-2
- Radiated field IEC 1000-4-3
- Fast transients IEC 1000-4-4
- Magnetic field at 50/60 Hz IEC 1000-4-8

⁽¹⁾ Conditions of reference: 18 °C at 28 °C, 20 to 75 % RH, 48 to 65 Hz, external magnetic field < 40 A/m, no DC component, no current-carrying conductor nearby, centred test sample, charge ≥ 1 MΩ and ≤ 100 pF, reset to zero before measurement (only DC) DC to 65 Hz, batteries 9 V ±0.1 V

To order	Reference
AC/DC current clamp model PAC11 with battery and user's manual	P01120068

Model PAC12 (insulated AC/DC current probe)

Current	40 A AC 60 A DC	400 A AC 600 A DC
Output	10 mV/A	1 mV/A

DESCRIPTION

The PAC12 model accurately measures AC or DC currents by using the Hall-effect principle.

This clamp with mV output on BNC (direct reading on oscilloscopes, etc.) is equipped with an automatic DC Zero system.

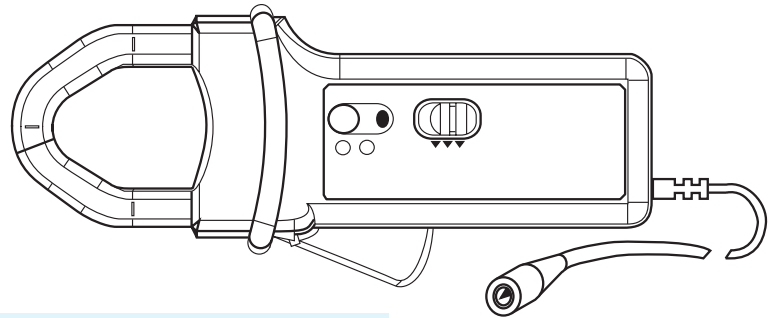

ELECTRICAL SPECIFICATIONS

- **Current range:**
0.2 A AC .. 40 A AC (60 A peak) / 0.4 A DC .. 60 A DC
0.5 A AC .. 400 A AC (600 A peak) / 0.5 A DC .. 600 A DC

- **Output signal:**
10 mV AC+DC / A AC+DC (0.6 V for 60 A)
1 mV AC+DC / A AC+DC (0.6 V for 600 A)

- **Accuracy and phase shift ⁽¹⁾:**

- 60 A calibre

Primary current	0.5 A .. 10 A	10 A .. 20 A	20 A .. 40 A	40 A .. 60 A (only DC)
% Accuracy of output signal	≤ 1.5 % + 5 mV	≤ 1.5 % + 5 mV	≤ 1.5 % + 5 mV	≤ 1.5 %
Phase shift	not specified	≤ 3°	≤ 2.2°	-

- 600 A calibre

Primary current	0.5 A .. 10 A	10 A .. 100 A	100 A .. 300 A	300 A .. 400 A	400 A .. 600 A (only DC)
% Accuracy of output signal	≤ 1.5 % + 1 mV	≤ 1.5 % + 1 mV	≤ 2 %	≤ 2 %	≤ 2.5 %
Phase shift	not specified	≤ 2.2°	≤ 2.2°	≤ 1.5°	-

- **Bandwidth:**
DC .. 10 kHz (-3 dB) (depending on current value)

- **Rise/fall time from 10 % to 90 %:**
29 μs

- **10 % delay time:**
15 μs

- **Insertion impedance (at 400 Hz / 10 kHz):**
< 2.7 mΩ / < 72 mΩ

- **Maximum currents:**
3,000 A DC or 1,000 A AC continuous for a frequency ≤ 1 kHz (limitation proportional to the inverse of one third of the frequency above that)

- **DC zero adjustment:**

Automatic

- 60 A calibre:
± 10 A in 25 to 40 mA increments

- 600 A calibre:
± 10 A in 25 to 40 mA increments

- **Typical output noise level (peak-peak) from DC to 100 kHz:**

- 60 A calibre:
DC to 1 kHz: ≤ 8 mV or 0.8 A DC
DC to 5 kHz: ≤ 12 mV or 1.2 A DC
0.1 Hz to 5 kHz: ≤ 2.0 mV_{RMS} or 0.2 A_{RMS}

- 600 A calibre:
DC to 1 kHz: ≤ 1 mV or 1 A DC
DC to 5 kHz: ≤ 1.5 mV or 1.5 A DC
1 Hz to 5 kHz: ≤ 500 μV_{RMS} or 0.5 A_{RMS}

- **Battery:**
9 V alkaline (NEDA 1604A, IEC 6LR61)

- **Battery life:**
50 hours typical

- **Typical consumption:**
10 mA typical / 14 mA max.

- **Battery level indicator:**
Green LED

- **Overload indication:**
Red LED indicates if measured current is too high for the selected range
Influence of power supply voltage:
≤ 0.1 % of the reading

- **Influence of temperature:**
Measurement: ≤ 300 ppm/K or 0.3 % of output signal per 10 °K
DC zero: 40 mA/10 °K

- **Influence of relative humidity:**
< 0.5 % of output signal

- **Influence of adjacent conductor at 23 mm:**
≤ 10 mA/A at 50 Hz

- **Influence of external field:**
≤ 1.3 A at 400 A/m

- **Influence of Ø 20 mm conductor position in jaws:**
DC to 440 Hz: ≤ 0.5 % of the reading
DC to 1 kHz: ≤ 1 % of the reading
DC to 2 kHz: ≤ 3 % of the reading
DC to 5 kHz: ≤ 10 % of the reading

- **Influence of frequency ⁽²⁾:**

< 1 % of output signal from 65 Hz .. 440 Hz
< 3.5 % of output signal from 440 Hz .. 2 kHz
3 dB % of output signal from 2 kHz .. 10 kHz

- **Common mode rejection:**
> 65 dB A/V at 50 Hz

- **Remanence:**
0 to 50 A DC: 0.8 A typical
0 to 100 A DC: 1.3 A typical
0 to 200 A DC: 2.1 A typical
0 to 400 A DC: 3.3 A typical
0 to 600 A DC: 4.0 A typical

MECHANICAL SPECIFICATIONS

- **Max. jaw opening:**
31 mm

- **Clamping capacity:**

Cables: Ø 30 mm
Ø 24 mm x 2
Bars: 1 busbar 50 x 10 mm
2 busbars 31.5 x 10 mm
3 busbars 25 x 8 mm
4 busbars 25 x 5 mm

- **Output:**
Coaxial cable 2 m long, terminated by an insulated BNC connector
- **Dimensions:**
224 x 97 x 44 mm
- **Weight:**
440 g with battery
- **Operating temperature:**
-10 °C to +55 °C
- **Storage temperature:**
-40 °C to +80 °C
- **Relative humidity for operation:**
0 to 85 % RH with a linear decrease above 35 °C
- **Operating altitude:**
0 to 2,000 m
- **Casing protection rating:**
IP40 (IEC 529)
- **Drop test:**
1 m (IEC 68-2-32)
- **Shock resistance:**
100 g / 6 ms / half-periode (IEC 68-2-27)
- **Protection against impacts:**
IK04 0.5 J (EN 50102)
- **Vibration resistance:**
5-15 Hz: 1.5 mm peak
15-25 Hz: 1 mm peak
25-55 Hz: 0.25 mm peak (IEC 68-2-6)
- **Self-extinguishing capability:**
UL94 V2
- **Colours:**
Dark grey casing with red jaws

SAFETY SPECIFICATIONS

- **Electrical safety:**
Instrument with double insulation or reinforced insulation between the primary the secondary and the grippable part located under the guard as per IEC 1010-1 & IEC 1010-2-032
- 600 V category III, pollution degree 2
- 300 V category IV, pollution degree 2
- **Electromagnetic compatibility (EMC):**
EN 50081-1: class B
EN 50082-2:
- Electrostatic discharge IEC 1000-4-2:
4 kV in contact, performance criterion B
8 kV in the air, performance criterion B
- Radiated field IEC 1000-4-3:
3 V/m level 2: influence < 5 % of measurement range
- Fast transients IEC 1000-4-4:
1 kV performance criterion B
- Magnetic field at the network frequency IEC 1000-4-8: field of 30 A/m at 50 Hz level 4 performance criterion A
- Conducted disturbances (IEC 1000-4-6):
3 V performance criterion A

(1) Conditions of reference: 23 °C ± 5 °K, 20 % at 75 % RH, power supply voltage 9 V ± 0.1 V DC sinusoidal signal with frequency of DC to 65 Hz, external magnetic field < 40 A/m, no DC components, no external conductor with circulating current, conductor centred for measurement, load impedance > 1 MΩ / < 100 pF.

(2) Out of reference domain.

To order	Reference
AC/DC current clamp model PAC12 for oscilloscope with battery and user's manual	P01120072

CURVES

60 A calibre

600 A calibre

Linearity with DC

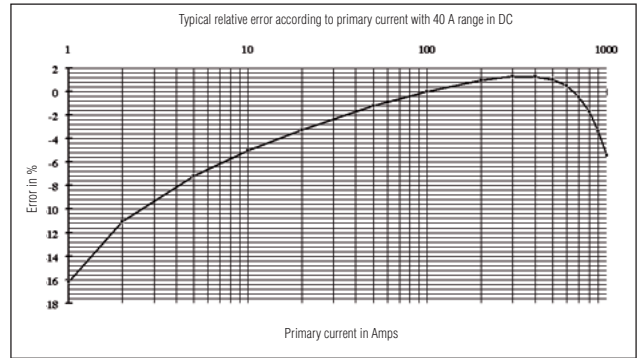
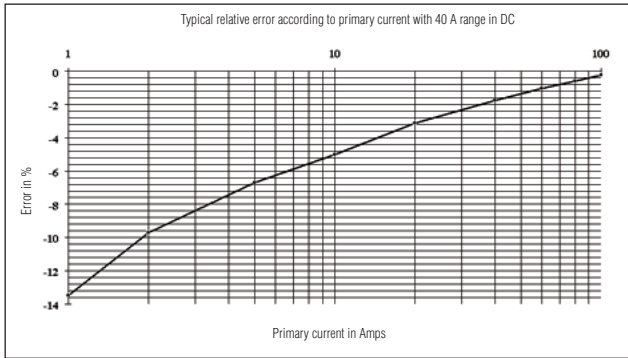

Linearity with AC

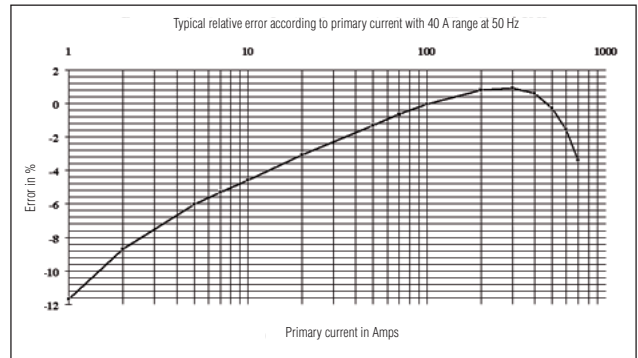
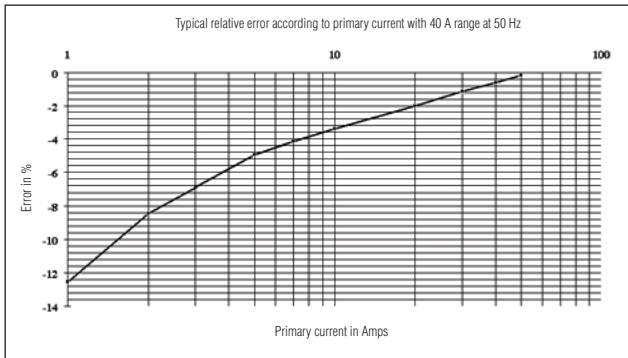

Phase shift

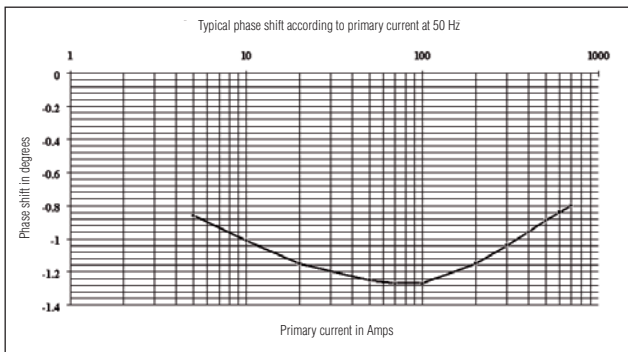

Limitation of measurable current according to the frequency

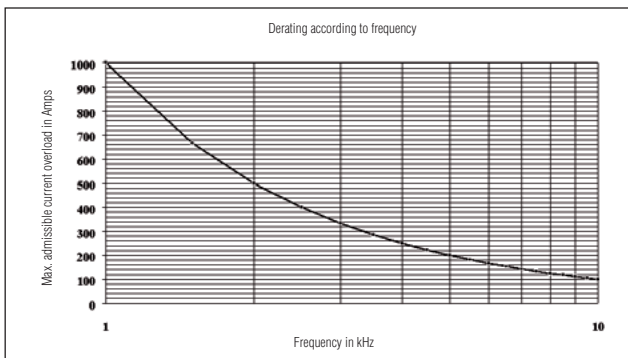

CURVES

600 A calibre

Frequency response

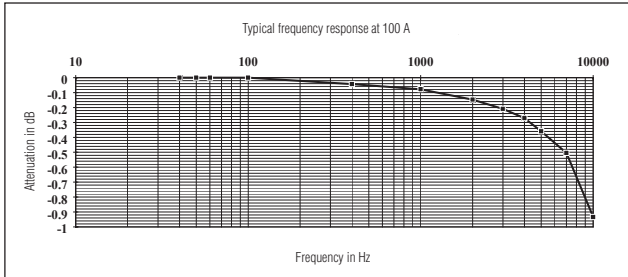

Attenuation according to the frequency

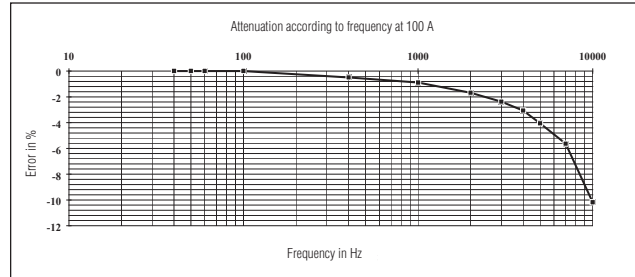

60 A calibre

600 A calibre

Pulse response

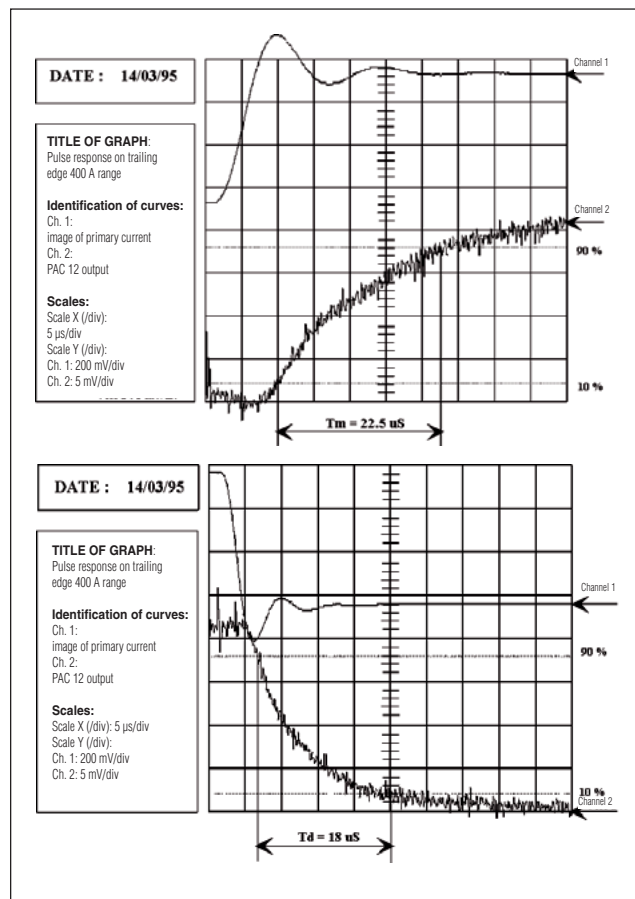
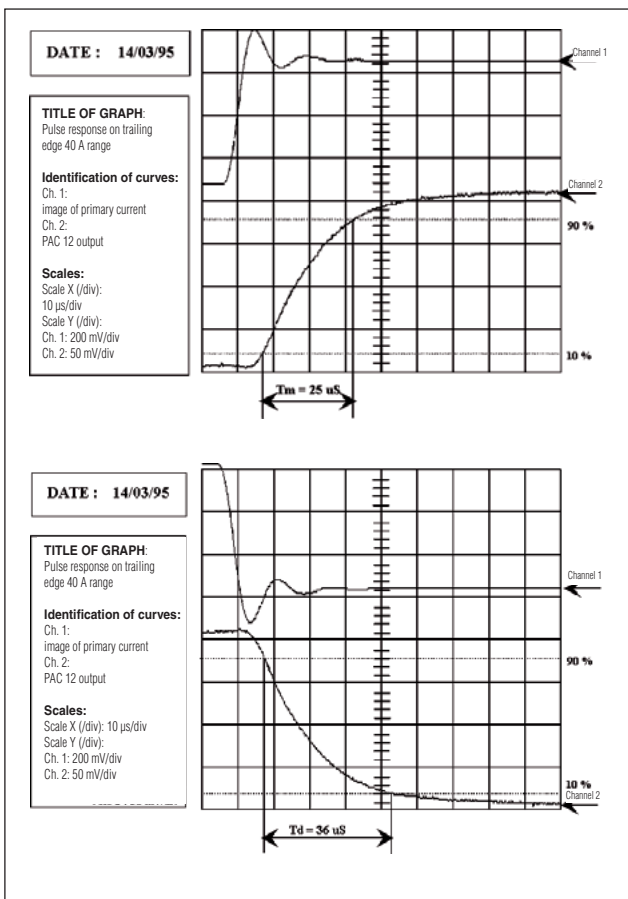

Current clamp for AC/DC current

Model PAC20

PAC series

Current	1,000 A AC 1,400 A DC
Output	1 mV/A

DESCRIPTION

The PAC20 model accurately measures AC or DC currents by using the Hall-effect principle. This clamp has a mV output so that direct readings may be made with a multimeter or logging equipment, etc.

ELECTRICAL SPECIFICATIONS

- Current range:**
0.5 A .. 1,000 A AC (1,400 A peak)
0.5 A .. 1,400 A DC
- Output signal:**
1 mV/A
- Accuracy ⁽¹⁾:**

Current range	1 A .. 100 A	100 A .. 800 A	800 A .. 1,000 A
Accuracy in % of output signal	1.5 % ± 1 mV	2.5 %	4 % 1,000 A .. 1,400 A DC: 4 %

- Phase shift ⁽¹⁾:**

Current range	10 A .. 200 A	200 A .. 1,000 A
Phase shift 45 Hz .. 65 Hz	< 2.5°	< 2°

- Overload:**
3,000 A DC and 2,000 A AC up to 1 kHz
- Bandwidth:**
DC .. 5 kHz
- Noise:**
DC .. 1 kHz: < 1 mV
DC .. 5 kHz: < 1.5 mV
0.1 Hz .. 5 kHz: < 500 µV
- Load impedance:**
> 100 kΩ at 100 pF
- Insertion impedance:**
0.39 mΩ at 50 Hz, 58 mΩ at 1,000 Hz
- Rise time and fall time:**
Rise:
< 100 µs from 10 % to 90 % of the voltage value
Fall:
< 100 µs from 10 % to 90 % of the voltage value
- Operating voltage:**
600 V_{RMS}
- Common mode voltage:**
600 V_{RMS}
- Influence of adjacent conductor:**
< 10 mA/A at 50 Hz
- Influence of conductor position in jaws:**
0.5 % of the reading
- Battery:**
9 V alkaline (NEDA 1604 A, IEC 6LR61)
- Low battery signal:**
Green LED when the battery voltage > 6.5 V

- Battery life:**
120 hours with Alkaline battery

MECHANICAL SPECIFICATIONS

- Operating temperature:**
-10 °C to +55 °C
- Storage temperature:**
-40 °C to +80 °C
- Relative humidity for operation:**
+10 °C to +35 °C: 90 ± 5 % RH (without condensation)
+40 °C to +55 °C: 70 ± 5 % RH (without condensation)
- Influence of temperature:**
< 300 ppm/°K or 0.3 %/10 °K
< 0.3 A/°K
- Influence of humidity:**
10 % .. 90 % RH at reference temperature: < 0.1 %
- Operating altitude:**
0 to 2,000 m
- Zero adjustment:**
±12 A (10-turn potentiometer)
- Max. jaw insertion capacity:**
1 cable Ø 42 mm, 2 cables from Ø 25.4 mm or
2 busbars from 50 x 5 mm
- Casing protection rating:**
IP30 in accordance with IEC 529

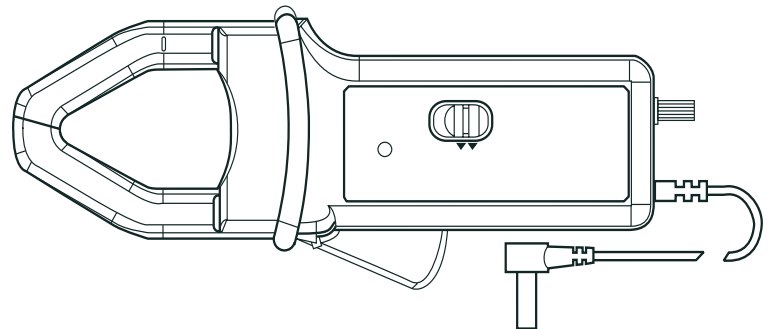

- Drop test:**
1 m on a 38 mm container of oak on concrete, test in accordance with IEC 1010
- Shock resistance:**
100 g, in accordance with IEC 68-2-27
- Vibration resistance:**
Test in accordance with IEC 68-2-6
- Frequency range:**
5 to 15 Hz: amplitude: 1.5 mm
15 to 25 Hz: amplitude: 1 mm
25 to 55 Hz: amplitude: 0.25 mm
- Self-extinguishing capability:**
Casing and jaws: UL 94 V0
- Dimensions:**
236.5 x 97 x 44 mm
- Weight:**
520 g
- Colours:**
Dark grey and red jaws
- Output:**
via 1.5 m double insulated cable with 4 mm male safety plug

SAFETY SPECIFICATIONS

- Electrical safety:**
Double or reinforced insulation between the primary and secondary circuits and the outer casing in accordance with IEC 1010-1-2 (indoor use).
600 V category III, pollution 2
300 V category IV, pollution 2
- Electromagnetic compatibility (EMC):**
EN 50081-1: class B
EN 50082-2:
- Electrical discharge IEC 1000-4-2
- Radiated field IEC 1000-4-3
- Fast transients IEC 1000-4-4
- Magnetic field at 50/60 Hz IEC 1000-4-8

(1) Conditions of reference: 18 °C at 28 °C, 20 % to 75 % RH, 48 Hz to 65 Hz, external magnetic field < 40 A/m, no DC component, no current-carrying conductor nearby, centred test sample, charge ≥ 1 MΩ and ≤ 100 pF, reset to zero before measurement (only DC) DC to 65 Hz, battery 9 V ± 0.1 V

To order	Reference
AC/DC current clamp model PAC20 with battery and user's manual	P01120071

Current clamp for AC/DC current

Model PAC21

PAC series

Current	100 A AC 150 A DC	1,000 A AC 1,400 A DC
Output	10 mV/A	1 mV/A

DESCRIPTION

The PAC21 model accurately measures AC or DC currents using the Hall-effect principle. This clamp with mV output (direct reading on multimeters, etc.) is equipped with an automatic DC zero system.

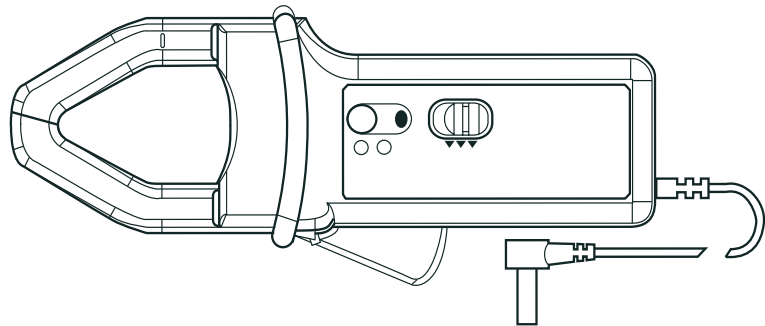

ELECTRICAL SPECIFICATIONS

Calibre	150 A	1,400 A
Current range	0.2 A .. 100 A (150 A peak) 0.4 A .. 150 A DC	0.5 A .. 1,000 A (1,400 A peak) 0.5 A .. 1,400 A DC
Output signal	10 mV/A	1 mV/A
Accuracy in % of output signal	0.5 A .. 20 A: 1.5% ±5 mV 20 A .. 100 A DC: 1.5% 100 A .. 150 A DC: 2.5%	0.5 A .. 100 A: 1.5% ±1 mV 100 A .. 800 A DC: 2.5% 800 A .. 1,000 A DC: 4% 1,000 A .. 1,400 A DC: 4%
Phase shift (45 .. 65 Hz) ⁽¹⁾	10 A .. 20 A: < 3° 20 A .. 100 A: < 2°	10 A .. 200 A: < 2° 200 A .. 1,000 A: < 1.5°
Noise	DC .. 1 kHz: < 8 mV DC .. 5 kHz: < 12 mV 0.1 Hz .. 5 kHz: < 2 mV	DC .. 1 kHz: < 1 mV DC .. 5 kHz: < 1.5 mV 0.1 Hz .. 5 kHz: < 500 µV
Rise/fall time	≤ 100 µs from 10% to 90% of the voltage value	≤ 70 µs from 10% to 90% of the voltage value

- **Overload:**
3,000 A DC and 2,000 A AC up to 1 kHz
- **Bandwidth:**
DC .. 10 kHz at -3 dB
- **Load impedance:**
≥ 1 MΩ and ≤ 100 pF
- **Insertion impedance:**
0.39 mΩ at 50 Hz, 58 mΩ at 1,000 Hz
- **Operating voltage:**
600 V_{RMS}
- **Common mode voltage:**
600 V_{RMS}
- **Influence of adjacent conductor:**
< 10 mA/A at 50 Hz
- **Influence of conductor position in jaws:**
0.5% of the reading
- **Battery:**
9 V alkaline (NEDA 1604 A, IEC 6LR61)
- **Low battery signal:**
Green LED when the battery voltage > 6.5 V
- **Battery life:**
50 hours with Alkaline battery
- **Overload indication:**
Red LED
- **Auto switch-off:**
10 minutes

MECHANICAL SPECIFICATIONS

- **Operating temperature:**
-10 °C to +55 °C
- **Storage temperature:**
-40 °C to +80 °C
- **Relative humidity for operation:**
+10 °C to +35 °C: 90 ± 5% RH (without condensation)
+40 °C to +55 °C: 70 ± 5% RH (without condensation)
- **Influence of temperature:**
< 300 ppm/°K or 0.3%/10°K
< 0.3 A/°K
- **Influence of humidity:**
10% at 90% RH at reference temperature: < 0.1%
- **Operating altitude:**
0 to 2,000 m
- **Zero adjustment:**
±10 A by push-button
- **Max. jaw insertion capacity:**
1 cable Ø 42 mm, 2 cables from Ø 25.4 mm or
2 busbars from 50 x 5 mm
- **Casing protection rating:**
IP30 in accordance with IEC 529

- **Drop test:**
1 m on a 38 mm container of oak on concrete, test in accordance with IEC 1010
- **Shock resistance:**
100 g, in accordance with IEC 68-2-27
- **Vibration resistance:**
test in accordance with IEC 68-2-6
- **Frequency range:**
5 to 15 Hz: amplitude: 1.5 mm
15 to 25 Hz: amplitude: 1 mm
25 to 55 Hz: amplitude: 0.25 mm
- **Self-extinguishing capability:**
Casing and jaws: UL94 V0
- **Dimensions:**
236.5 x 97 x 44 mm
- **Weight:**
520 g
- **Colours:**
Dark grey and red jaws
- **Output:**
Via 1.5 m double insulated cable with 4 mm male safety plug

SAFETY SPECIFICATIONS

- **Electrical safety:**
Double or reinforced insulation between the primary and secondary circuits and the outer casing in accordance with IEC 1010-1-2 (indoor use).
600 V category III, pollution 2
300 V category IV, pollution 2
- **Electromagnetic compatibility (EMC):**
EN 50081-1: class B
EN 50082-2:
- Electrical discharge IEC 1000-4-2
- Radiated field IEC 1000-4-3
- Fast transients IEC 1000-4-4
- Magnetic field at 50/60 Hz: IEC 1000-4-8

(1) Conditions of reference: 18 °C at 28 °C, 20% to 75% RH, 48 Hz to 65 Hz, external magnetic field < 40 A/m, no DC component, no current-carrying conductor nearby, centred test sample, charge ≥ 1 MΩ and ≤ 100 pF, reset to zero before measurement (only DC) DC to 65 Hz, battery 9 V ± 0.1 V

To order	Reference
AC/DC current clamp model PAC21 with battery and user's manual	P01120069
AC/DC current clamp model PAC21 in carrying case with battery and user's manual	P01120069D

Model PAC22 (insulated AC/DC current probe)

Current	100 A AC 150 A DC	1,000 A AC 1,400 A DC
Output	10 mV/A	1 mV/A

DESCRIPTION

The PAC22 model accurately measures AC or DC currents using the Hall-effect principle.

This clamp with mV output on BNC (direct reading on oscilloscopes, etc.) is equipped with an automatic DC zero system.

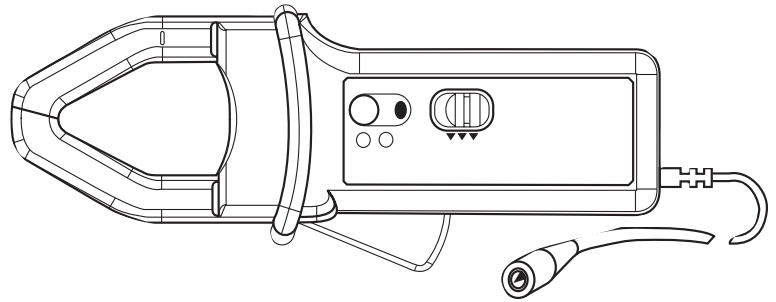

ELECTRICAL SPECIFICATIONS

- Current range:**
0.2 A AC .. 100 A AC (150 A peak) / 0.4 A DC .. 150 A DC
0.5 A AC .. 1,000 A AC (1,400 A peak) / 0.5 A DC .. 1,400 A DC

- Output signal:**
10 mV AC+DC / A AC+DC (1.5 V for 150 A)
1 mV AC+DC / A AC+DC (1.4 V for 1,400 A)

- Accuracy and phase shift ⁽¹⁾:**

- 150 A calibre

Primary current	0.5 A .. 10 A	10 A .. 20 A	20 A .. 100 A	100 A .. 150 A (only DC)
% Accuracy of output signal	≤ 1.5 % + 5 mV	≤ 1.5 % + 5 mV	≤ 1.5 %	≤ 1.5 %
Phase shift	not specified	≤ 3°	≤ 2.2°	-

- 1,400 A calibre

Primary current	0.5 A .. 10 A	10 A .. 100 A	100 A .. 200 A	200 A .. 800 A	800 A .. 1,000 A	1,000 A .. 1,400 A (only DC)
% Accuracy of output signal	≤ 1.5 % + 1 mV	≤ 1.5 % + 1 mV	≤ 2.5 %	≤ 2.5 %	≤ 4 %	≤ 4 %
Phase shift	not specified	≤ 2°	≤ 2°	≤ 1.5°	≤ 1.5°	-

- Bandwidth:**
DC .. 10 kHz (-3 dB) (depending on current value)

- Rise/fall time from 10 % to 90 %:**
24 μs

- 10 % delay time:**
15 μs

- Insertion impedance (at 400 Hz / 10 kHz)**
< 2.7 mΩ / < 67 mΩ

- Maximum currents:**
3,000 A DC or 1,000 A AC continuous for a frequency ≤ 1 kHz (limitation proportional to the inverse of one third of the frequency above that)

- DC zero adjustment:**

Automatic

- 60 A calibre:

± 10 A in 25 mA to 40 mA increments

- 600 A calibre:

± 10 A in 25 mA to 40 mA increments

- Typical output noise level (peak-peak) from DC to 100 kHz:**

- 150 A calibre:

DC to 1 kHz: ≤ 8 mV or 0.8 A DC

DC to 5 kHz: ≤ 12 mV or 1.2 A DC

0.1 Hz to 5 kHz: ≤ 2.0 mV_{RMS} or 0.2 A_{RMS}

- 1,400 A calibre:

DC to 1 kHz: ≤ 1 mV or 1 A DC

DC to 5 kHz: ≤ 1.5 mV or 1.5 A DC

1 Hz to 5 kHz: ≤ 500 μV_{RMS} or 0.5 A_{RMS}

- Output impedance:**

100 Ω

- Battery:**

9 V alkaline (NEDA 1604A, IEC 6LR61)

- Battery life:**

50 hours typical

- Typical consumption:**

10 mA typical / 14 mA max.

- Battery level indicator:**

Green LED

- Overload indication:**

Red LED indicates the measured current is too high for the selected range

Influence of power supply voltage:

≤ 0.1 % of the reading

- Influence of temperature:**

Measurement: ≤ 300 ppm/K or 0.3 % of output signal per 10 °K

DC zero: 40 mA/10 °K

- Influence of relative humidity:**

< 0.5 % of output signal

- Influence of adjacent conductor at 23 mm:**

≤ 10 mA/A at 50 Hz

- Influence of external field:**

≤ 1.3 A for 400 A/m

- Influence of Ø 20 mm conductor position in jaws:**

DC to 440 Hz: ≤ 0.5 % of the reading

DC to 1 kHz: ≤ 1 % of the reading

DC to 2 kHz: ≤ 3 % of the reading

DC to 5 kHz: ≤ 10 % of the reading

- Influence of frequency ⁽²⁾:**

< 1 % of output signal from 65 Hz .. 440 Hz

< 3.5 % of output signal from 440 Hz .. 2 kHz

3 dB of output signal from 2 kHz .. 10 kHz

- Common mode rejection:**

> 65 dB A/V at 50 Hz

- Remanence:**

0 to 100 A DC: 1 A typical

0 to 250 A DC: 1.7 A typical

0 to 500 A DC: 2.5 A typical

0 to 1,000 A DC: 3.6 A typical

0 to 1,400 A DC: 4.4 A typical

MECHANICAL SPECIFICATIONS

- **Max. jaw opening:**
31 mm
- **Clamping capacity:**
Cables: Ø 39 mm
 Ø 25.4 mm x 2
Bars: 1 busbar 50 x 12.5 mm
 2 busbars 50 x 5 or 31.5 x 10 mm
 3 busbars 25 x 8 mm
 4 busbars 25 x 5 mm
- **Output:**
Coaxial cable 2 m long, terminated by an insulated BNC connector
- **Dimensions:**
236.5 x 97 x 44 mm
- **Weight:**
520 g with battery
- **Operating temperature:**
-10 °C to +55 °C
- **Storage temperature:**
-40 °C to +80 °C

- **Relative humidity for operation:**
0 to 85 % RH with a linear decrease above 35 °C
- **Operating altitude:**
0 to 2,000 m
- **Casing protection rating:**
IP40 (IEC 529)
- **Drop test:**
1 m (IEC 68-2-32)
- **Shock resistance:**
100 g / 6 ms / half-periode (IEC 68-2-27)
- **Protection against impacts:**
IK04 0.5 J (EN 50102)
- **Vibration resistance:**
5-15 Hz: 1.5 mm peak
15-25 Hz: 1 mm peak
25-55 Hz: 0.25 mm peak
(IEC 68-2-6)
- **Self-extinguishing capability:**
UL94 V2
- **Colours:**
Dark grey case with red jaws

SAFETY SPECIFICATIONS

- **Electrical safety:**
Instrument with double insulation or reinforced insulation between the primary the secondary and the grippable part located under the guard as per IEC 1010-1 & IEC 1010-2-032
- 600 V category III, pollution degree 2
- 300 V category IV, pollution degree 2
- **Electromagnetic compatibility (EMC):**
EN 50081-1: class B
EN 50082-2:
- Electrostatic discharge IEC 1000-4-2:
4 kV in contact, performance criterion B
8 kV in the air, performance criterion B
- Radiated field IEC 1000-4-3:
3 V/m level 2: influence < 5 % of measurement range
- Fast transients IEC 1000-4-4:
1 kV performance criterion B
- Magnetic field at the network frequency (IEC 1000-4-8): field of 30 A/m at 50 Hz level 4 performance criterion A
- Conducted disturbances (IEC 1000-4-6):
3 V performance criterion A

(1) Conditions of reference: 23 °C ± 5 °K, 20 % at 75 % RH, power supply voltage 9 V ± 0.1 V DC sinusoidal signal with frequency of DC to 65 Hz, external magnetic field < 40 A/m, no DC components, no external conductor with circulating current, conductor centred for measurement, load impedance > 1 MΩ / < 100 pF.

(2) Out of reference domain.

To order	Reference
Current clamp for AC/DC current model PAC22 for oscilloscope with battery and user's manual	P01120073

Oscilloscope clamp for AC/DC current

Model PAC22 (insulated AC/DC current probe)

PAC series



CURVES

150 A calibre

1,400 A calibre

Linearity in DC

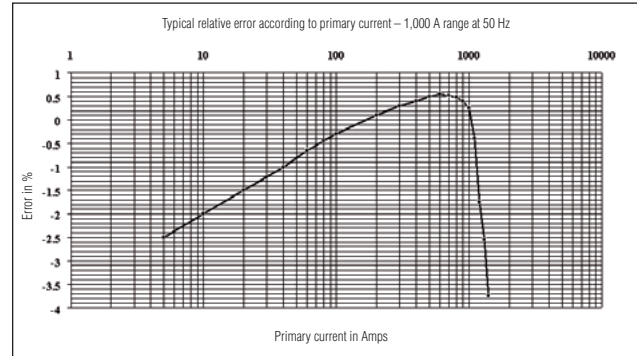
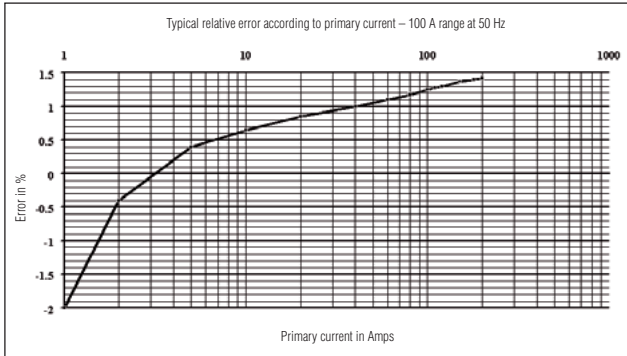

Linearity in AC

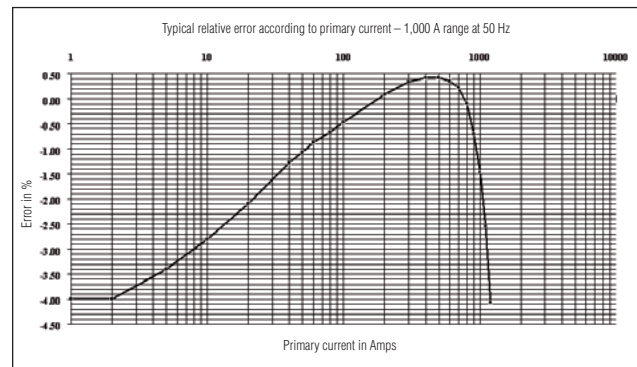
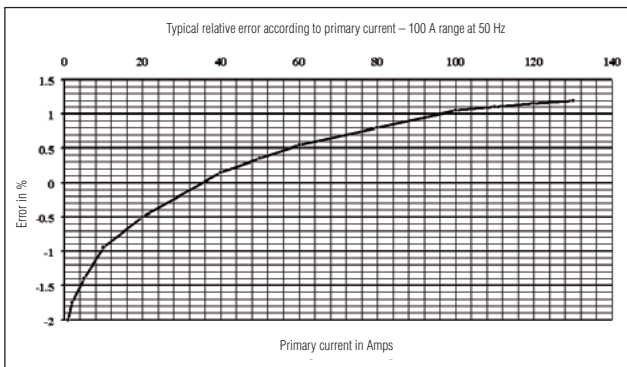

Limitation of measurable current according to the frequency

Phase shift

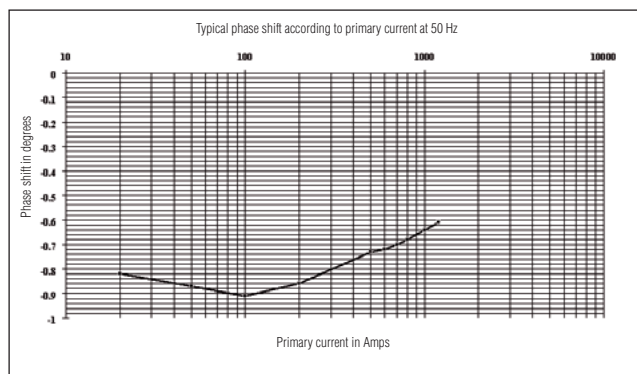
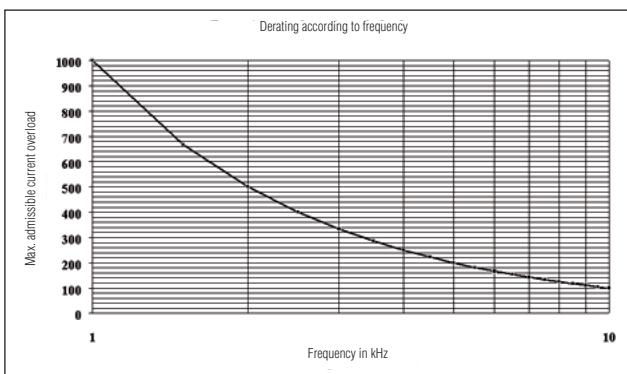

Oscilloscope clamp for AC/DC current

Model PAC22 (insulated AC/DC current probe)

PAC series

CURVES

Frequency response

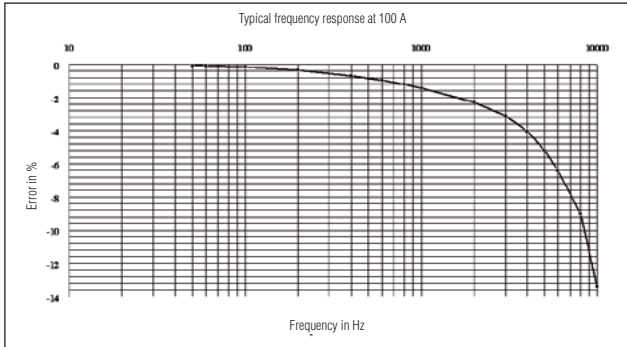

150 A calibre

Attenuation according to frequency

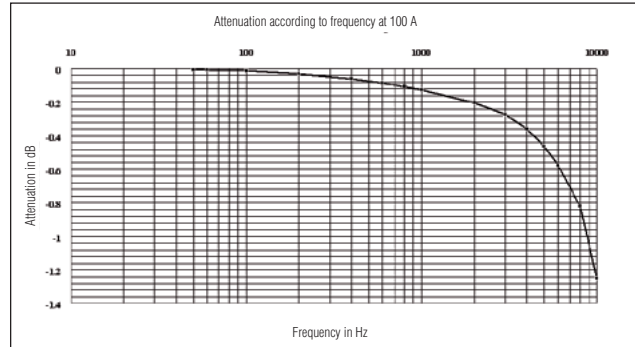

1,400 A calibre

Pulse response

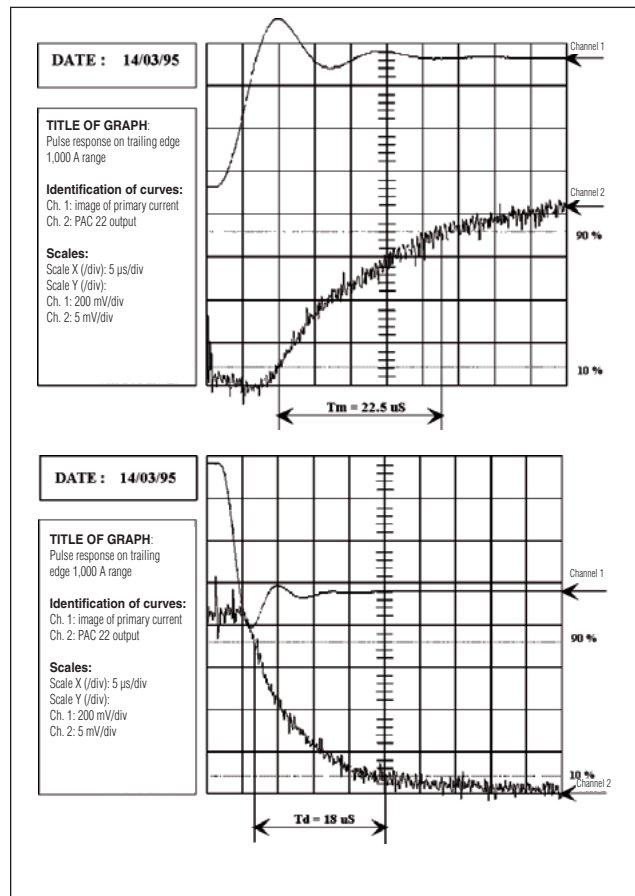
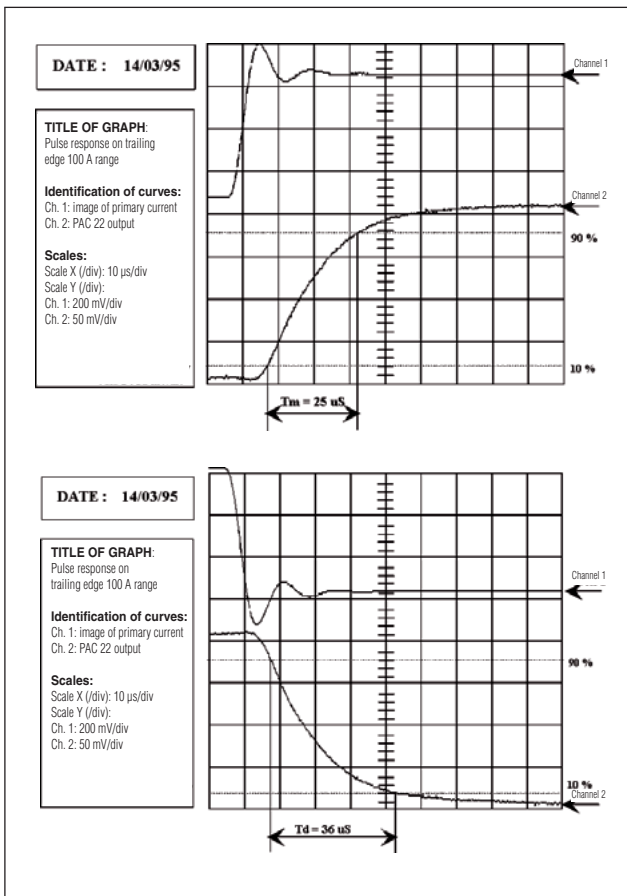



CLAMP ACCESSORIES

Having made test, control and measurement instruments for over a century now, Chauvin Arnoux products are the result of years of experience in the field. A knowledge of measurement techniques and daily experience in safety practices has led to the development of an entire range of practical and safety-conscious test accessories. Throughout the range, from the artificial neutral to the BNC/ female safety socket, or silicone leads with banana plugs (straight or elbowed), the IEC 61010 standard is the benchmark by which all products are judged.

However, even a device that complies with this standard does not guarantee complete safety, so make sure that you are equipped with suitable accessories with which you can verify that your equipment meets the most demanding safety standards.

Mains adapters

For unlimited operation of your current clamps, replace the battery with the mains adapter.

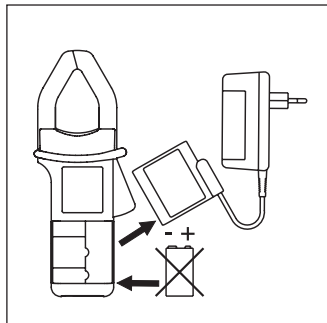

For PAC clamp

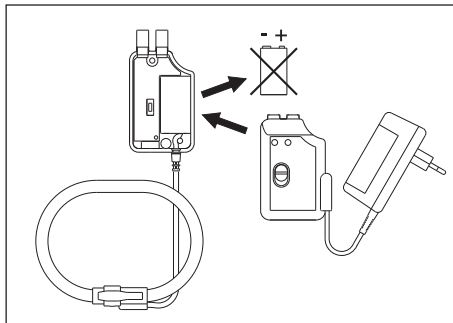

For AmpFlex® A100 clamp,
MiniFlex® MA100 clamp and K clamp



For MiniFlex® MA110 clamp, MiniFlex® MA130 clamp,
AmpFlex® A110, AmpFlex® A130 clamp and MH60 clamp

To order	Reference
Mains adapter for E clamp	P01101965
Mains adapter for K clamp	P01101966
Mains adapter for PAC clamp	P01101967
Mains adapter for AmpFlex® A100	P01101968
Mains adapter for MiniFlex® MA100 clamp	P01102086
Mains adapter for MiniFlex® MA200 clamp	P01102087
Mains adapter for MiniFlex® MA110, MiniFlex® MA130, AmpFlex® A110, AmpFlex® A130 and MH60	P01651023

Leads and adapters



- **Standard PVC leads**
Straight male plug Ø 4 mm
Elbowed male plug Ø 4 mm
15 A / 1.5 m
600 V CAT IV
1,000 V CAT III



- **BNC / banana adapter**
Insulated female socket
Insulated male plugs
Ø 4 mm with 19 mm spacing
600 V CAT III



- **Banana-BNC leads**
Insulated BNC
Male plug Ø 4 mm
with rear connection
500 V CAT III



- **BNC / banana adapter**
Male BNC
Female sockets
500 V CAT I
150 V CAT III



- **BNC / banana adapter**
Male BNC
Male plugs
500 V CAT I
150 V CAT III

To order	Reference
Standard PVC leads (1 red + 1 black)	P01295289Z
Banana-BNC leads	AG-1066Z
Male BNC / Female banana adapter (set of 2)	P01101846
Male BNC / Male banana adapter (set of 2)	P01101847
Female BNC / Isolated banana adapter (set of 2)	P01102101Z

Artificial neutral box

Model AN1

Accessories

DESCRIPTION

This instrument is designed for use with MN73, C173 and B102 leakage-current detection clamps to enable fault current measurements on 3-phase circuits without a neutral conductor.

There is a switch for selecting the test rate so that the MN73, C173 and B clamps can be used with digital or analogue multimeters.

A built-in buzzer indicates when the artificial neutral is connected to the earth. Three LEDs indicate when a voltage is present on each of the 3 phases and during measurement.

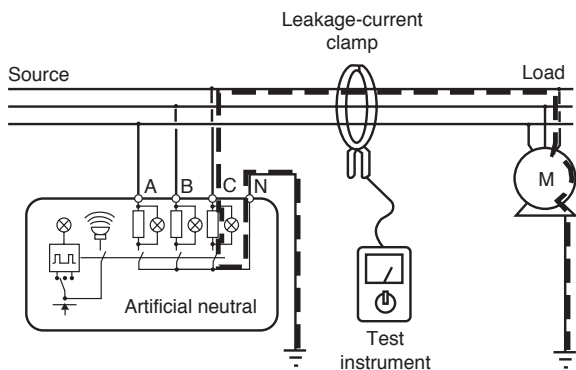

ELECTRICAL SPECIFICATIONS

- **Operating voltage:**
30 V at 600 V
- **Frequency range:**
45 at 65 Hz
- **Resistance per phase:**
3.9 k Ω \pm 5 %
- **Make/break period:**
Slow position: 0.5 s
Fast position: 2.3 s
- **Battery:**
12 V DC, 8 \times 1.5 V "AA" batteries
- **Consumption:**
180 mA
- **Battery life:**
40 hours

MECHANICAL SPECIFICATIONS

- **Reference temperature:**
23 $^{\circ}$ C \pm 3 $^{\circ}$ C
- **Operating temperature:**
0 $^{\circ}$ C to +50 $^{\circ}$ C, between 10 % and 90 % RH
- **Storage temperature:**
-40 $^{\circ}$ C to +70 $^{\circ}$ C, between 10 % and 90 % RH
- **Self-extinguishing capability:**
UL94 V0
- **Colour:**
yellow
- **Dimensions:**
220 x 136 x 150 mm
- **Weight:**
1.3 Kg

SAFETY SPECIFICATIONS

- **Dielectric test:**
6 kV between the lead and the unit
- **Operating voltage:**
600 V RMS

To order	Reference
AN1 artificial neutral box with shoulder bag, batteries, set of leads, croc-clips and user's manual	P01197201
Accessories: spare shoulder bag no. 2	P01298006

Date: _____ / ____ / ____

ADDRESS DETAILS

Surname: _____ Profession: _____
 First name: _____ Sector of industry: _____
 Company: _____
 Address: _____
 Town: _____
 Post code: _____ Tel: _____
 Country: _____ Fax: _____

APPLICATION DETAILS

Description/comments: _____

DESIRED SPECIFICATION

- Type of measurement: AC DC AC + DC
- Measurement range: from _____ A to _____ A
- Accuracy: _____ % of output signal
- Bandwidth: from _____ Hz to _____ Hz
- Output signal: A AC V AC V DC
- Number of calibres: _____
 - 1 calibre: _____ A Sensitivity: _____ /A
 - 2 calibre: _____ A Sensitivity: _____ /A
 - 3 calibre: _____ A Sensitivity: _____ /A
- Operating open circuit (or working) voltage of the installation where the measurements are to be carried out:
 - 230 V 400 V 600 V 1000 V Other: _____ V
- Diameter of measured conductor: _____ mm or dimensions: x _____ mm
- Temperature of conductor in use: from _____ ° to _____ ° °C °F
- Output connector:
 - Safety sockets Ø 4 mm
 - Length of lead 1.5 m + safety plug Ø 4 mm
 - 2 m coaxial lead with isolated BNC
 - Other: _____
- Colour:
 - Jaws: Red CHAUVIN ARNOUX (standard)
 - Other: _____
 - Casing: Grey CHAUVIN ARNOUX (standard)
 - Other: _____

DELIVERY FORMAT

- Without instruction manual
- With CHAUVIN ARNOUX instruction manual (standard)
- With customized operating instructions
- CHAUVIN ARNOUX product marking (standard)
- Customized brand markings (supply all plans, diagrams, logo, etc. necessary for personalisation)
- **Packaging**
 - Standard CHAUVIN ARNOUX cardboard box
 - Plain cardboard box
 - Other _____

YOUR ORDER

First delivery quantity: _____ Desired delivery time: _____
 Quantity per year: _____ Frequency of deliveries: _____



4 expert measurement

companies in one Group



Portable test and measurement instrumentation

CHAUVIN ARNOUX draws on its two brands, Chauvin Arnoux® and Metrix®, to propose a wide range of measuring instruments. The offering covers electrical measurement (testers, multimeters and current clamps), electrical safety checking, wattmeters and electrical network quality analyzers. Oscilloscopes, electronic equipment testers and environmental measurements complete the range of its expertise.



Temperatures in industrial processes

PYROCONTROLE proposes tailored solutions for the temperature measurement and control requirements of all process industries. A wide range of sensors and total mastery of the industrial process chain make **PYROCONTROLE** an essential partner for industries such as the nuclear sector, petrochemicals, glass-making, metallurgy, etc.



Metrology and regulatory testing

MANUMESURE is the CHAUVIN ARNOUX Group company specialized in metrology and regulatory testing. Its offering is structured around three major market segments: Industry, Environment and Health.



Metering, measurement and energy performance

ENERDIS designs measuring instruments for electrical switchboards and develops smart systems for electricity metering and mastery of energy flows in order to keep consumption under control.

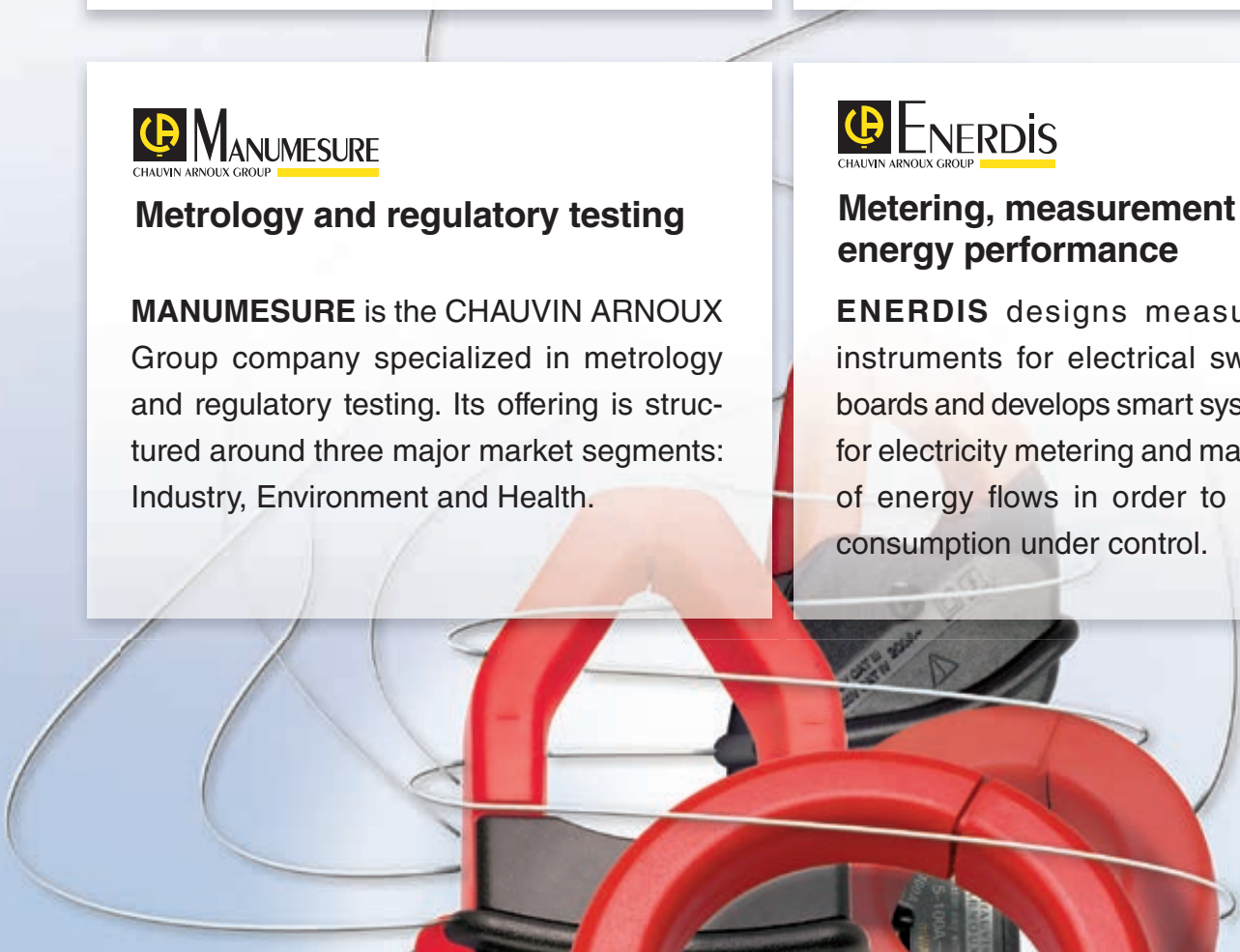

A local service for a better service

Contacts in your country

UNITED KINGDOM

Chauvin Arnoux Ltd

Unit 1 Nelson Ct, Flagship Sq
Shaw Cross Business Pk, Dewsbury
West Yorkshire - WF12 7TH
Tel.: +44 1924 460 494
Fax: +44 1924 455 328
info@chauvin-arnoux.co.uk
www.chauvin-arnoux.com

MIDDLE EAST

Chauvin Arnoux Middle East

PO Box 60-154
1241 2020 JAL EL DIB
(Beyrouth) - LIBAN
Tel.: +961 1 890 425
Fax: +961 1 890 424
camie@chauvin-arnoux.com
www.chauvin-arnoux.com

USA

Chauvin Arnoux Inc

d.b.a AEMC Instruments
15 Faraday Drive
Dover - NH 03820
Tel.: +1 (800) 945-2362
Fax: +1 (603) 742-2346
sales@aemc.com
www.aemc.com

Worldwide

10 subsidiaries

AUSTRIA

Chauvin Arnoux Ges.m.b.H

Tel.: +43 1 61 61 9 61
Fax: +43 1 61 61 9 61-61
vie-office@chauvin-arnoux.at
www.chauvin-arnoux.at

CHINA

Shanghai Pu-Jiang Enerdis Instruments Co. Ltd

Tel.: +86 21 65 21 51 96
Fax: +86 21 65 21 61 07
info@chauvin-arnoux.com.cn

GERMANY

Chauvin Arnoux GmbH

Tel.: +49 7851 99 26-0
Fax: +49 7851 99 26-60
info@chauvin-arnoux.de
www.chauvin-arnoux.de

ITALY

AMRA SpA

Tel.: +39 039 245 75 45
Fax: +39 039 481 561
info@amra-chauvin-arnoux.it
www.chauvin-arnoux.it

MIDDLE EAST

Chauvin Arnoux Middle East

Tel.: +961 1 890 425
Fax: +961 1 890 424
camie@chauvin-arnoux.com
www.chauvin-arnoux.com

SPAIN

Chauvin Arnoux Ibérica SA

Tel.: +34 902 20 22 26
Fax: +34 934 59 14 43
info@chauvin-arnoux.es
www.chauvin-arnoux.es

SCANDINAVIA

CA Mätssystem AB

Tel.: +46 8 50 52 68 00
Fax: +46 8 50 52 68 10
info@camatsystem.com
www.camatsystem.com

SWITZERLAND

Chauvin Arnoux AG

Tel.: +41 44 727 75 55
Fax: +41 44 727 75 56
info@chauvin-arnoux.ch
www.chauvin-arnoux.ch

UNITED KINGDOM

Chauvin Arnoux Ltd

Tel.: +44 1924 460 494
Fax: +44 1924 455 328
info@chauvin-arnoux.co.uk
www.chauvin-arnoux.com

USA

Chauvin Arnoux Inc

Tel.: +1 (508) 698-2115
Fax: +1 (508) 698-2118
sales@aemc.com
www.aemc.com